

Viabizzuno progettiamo la luce

Viabizzuno strada principale della frazione di bizzuno in provincia di ravenna dove tra la casa del popolo e la parrocchia, al n°17, sono nato il ventuno luglio millenovecentocinquantacinque. da qui nasce il nome della fabbrica di produzione fondata nel millenovecentonovantaquattro rappresentata da uno spazio bianco attraversato da due linee. una verticale, rigorosa, essenziale, equilibrata: la luce per la luce; ed una inclinata, irriverente nello spazio, ironica, fuori dagli schemi: la luce per la forma. distinte ma complementari si fondono in un unico nome: Viabizzuno.

Viabizzuno is the name of the main road of the small village bizzuno located in the province of ravenna, where I was born on the 21 07 1955 at n°17, between the 'casa del popolo' and the local parish church. from here the name of the factory founded in nineteen ninety-four represented by a white space intersected by two lines. one vertical, well balanced, logical, essential: the light for the light. the other one dynamic, irreverent, ironic: the light for the form. separate and yet complementary they cast in the same name: Viabizzuno. mario nanni

*i progetti rendono gli oggetti eterni,
le mode li corrompono, gli imbecilli li copiano
e li vendono agli ignoranti e ai deficienti.
noi progettiamo e lavoriamo per aiutare la luce
ad emozionarvi.*

*i frutti delle nostre idee e dei nostri progetti
sono protetti da brevetti
e/o modelli registrati
e/o da diritto d'autore.*

design makes objects timeless,
fashion corrupts them,
fools copy them and sell them to
ignorants and idiots.
we do projects and work to help light to bring
you true emotion.
the results of our ideas and our projects
are protected by patents
and/or registered models
and/or copyright.

al fine di offrire ai nostri clienti la massima qualità della luce utilizzando le più avanzate tecnologie, forti del nostro sapere artigiano costruito in Italia, aggiorniamo costantemente i nostri apparecchi di illuminazione.

Viabizzuno si riserva il diritto di apportare ai propri modelli, senza nessun preavviso, qualsiasi modifica ritenesse opportuna. per dimensioni e codici fanno fede i nostri strumenti di lavoro www.Viabizzuno.com, Viacommerce@,

Viabizzunoapplight e Viabizzunoonline. la progettazione degli apparecchi di illuminazione e dei relativi componenti è eseguita utilizzando i millimetri come unità di misura. le dimensioni espresse in pollici sono indicative e frutto di conversioni soggette a tolleranze.

in order to provide to our customers the maximum quality of light using the most advanced technologies, being strong of our artisan knowledge made in Italy, we constantly update our lighting fixtures.

Viabizzuno reserves the right to make any modification, considered worthwhile, to its own models, without any notification. for valid dimensions and codes please consult our working tools www.Viabizzuno.com, Viacommerce@,

Viabizzunoapplight and Viabizzunoonline. when designing lighting fixtures and related components, the unit of measure used is the millimetre. dimensions expressed in inches are indicative and are the result of conversions subject to tolerances.

lettura delle tabelle tecniche how to read technical tables

xxxxxxxxxxxxxxxx				120V 50-60Hz		A		wet		UL US		i	
a	b	c	d	e	f	f	g						
			K	damp									
				dry									

xxxxxxxxxxxxxxxx				120V 50-60Hz		A		wet		UL US		i	
Vbx.xxx.xx	nero55	3000K	35W	20°	0,8kg	1.8lb							
h	i	l	m	n	g								

componenti. components.

accessori. accessories.

1	2	3	4	5	6	7	8	9	10				
Ra	R9	ies tm-30		sdcm	mA	V _{f (min)}	lm	W	lm/W				
98	98	Rf 96	Rg 103	step 1	350	27,6	1240	9,7	128	A++			
xm000	les19	Ta25 °C			500	27,9	1580	14,0	113	A+			
		vita media · average life			70000 h	L80 B10							
11	12					13	14						

bandella tecnica. posizioni standard simbologie.
data plate. standard arrangement of symbols.

a	nome apparecchio di illuminazione · light fitting name
b	tensione di alimentazione · supply rating (Volt)
c	frequenza di alimentazione · supply frequency (Hertz)
d	alimentatore incluso o escluso · power supply included or not included
e	classificazione ambiente di installazione · installation location rating
f	marchio di certificazione · safety and quality standards certification
g	peso netto · net weight (kg/lb)
h	codice · code
i	finiture · colours and finishes
l	temperatura colore sorgente elettronica colour temperature led source (Kelvin)
m	potenza della sorgente · source power (Watt)
n	gradi fascio luminoso · light beam degrees

componenti. identifica tutti gli elementi indispensabili per la corretta funzionalità e installazione dell'apparecchio di illuminazione.
components. includes all items that are essential to the correct operation and installation of the light fitting.

accessori. si riferisce alle ulteriori parti installabili sull'apparecchio.
accessories. refers to items that can be added to the light fitting.

1	indice di resa cromatica · colour rendering index
2	indice di resa del rosso · red colour rendering index
3	Rf indice di fedeltà colore · colour fidelity index Rg indice di saturazione colore · color gamut index
4	step di macadam · macadam step
5	corrente di alimentazione · power supply current
6	tensione di alimentazione · power supply voltage
7	flusso luminoso · light flux
8	potenza della sorgente · source power
9	efficienza della sorgente · source efficiency
10	classe di efficienza energetica · efficiency class
11	codice sorgente elettronica Viabizzuno · Viabizzuno led source code
12	superficie emittente · light emitting surface (mm)
13	% flusso residuo a fine vita · end life % flux
14	% consentita sotto limite · allowed % under limit

legenda simboli symbols legenda



prodotto in conformità con le direttive nord americane sui soffioni doccia · produced in compliance with showerheads northamerican directives



componente certificato per il mercato nord americano idoneo ad essere utilizzato e valutato come parte di in un sistema più complesso
component approved for north american market and suitable to be used and approved as part of a more complex system



prodotto finito idoneo per essere commercializzato nel mercato nord americano · listed product suitable for the north american market



prodotto finito idoneo per essere commercializzato nel mercato nord americano · listed product suitable for the north american market



pending

apparecchio di illuminazione in corso di certificazione per essere commercializzato nel mercato nord americano
light fitting undergoing certification to be marketed in the north american market

wet

prodotto classificato per uso esterno · product classified for outdoor use

damp

prodotto classificato per uso interno in ambienti umidi (bagno, sauna, ecc..) · product classified for indoor use in damp environments (bathrooms, saunas, etc.)

dry

prodotto classificato per uso interno in ambienti asciutti · product classified for indoor use in dry environments



vetro opalino · opal glass



vetro sabbiato · sanded glass



vetro nero fumè · black smoke glass



vetro trasparente · transparent glass



vetro bianco latte · white milk glass



cristallo · crystal



policarbonato opalino · opal polycarbonate diffuser



carrabile · drive over

a

fascio asimmetrico · asymeric beam

e

fascio ellittico · elliptical beam

w

wallwasher

- A** alimentatore incluso · power supply included
- A** alimentatore escluso · power supply not included
- AR** alimentatore remoto incluso · remote power supply included
- Ai** alimentatore elettronico con controllo intelligente incluso · electronic power supply with smart control included
- AiR** alimentatore elettronico con controllo intelligente incluso, da installare remoto · electronic power supply with smart control included, to be installed remotely
- AS** alimentatore a spina incluso · plug power supply included
- T** trasformatore incluso · transformer included
- K** kit di cablaggio incluso · wiring kit not included
- K** kit di cablaggio escluso · wiring kit not included
- L** lampadina con sorgente elettronica led, ad incandescenza, alogena o fluorescente inclusa.
bulb with led electronic source, incandescent, halogen or fluorescent included.
- L** lampadina con sorgente elettronica led, ad incandescenza, alogena o fluorescente esclusa.
bulb with led electronic source, incandescent, halogen or fluorescent not included.
- pr** propulsore dinamico n55 incluso · included
-  attenzione: sorgente luminosa led. non guardare mai direttamente a occhio nudo · attention: led light source. never look straight without eye protection
- i** peso netto · net weight (kg)
- ⚡** possibilità di combinazione tra interfaccia n55, propulsore dinamico n55 e lampadina n55 · possible combination between n55 interface, propulsore dinamico n55 and n55 bulb
- l.d.** luce diretta · direct light
- l.i.** luce indiretta · indirect light
- V** disponibile su · available on *Viabizzuno applight* www.Viabizzuno.com *Viabizzuno online*



scala · scale 1:1

apparecchio di illuminazione a parete o soffitto per interni. realizzato in estruso di alluminio ossidato di sezione piana, completo di diffusore curvo in policarbonato estruso. per il fissaggio utilizzare le apposite clip in dotazione.

dimensioni: sezione 17,5x11mm/0.6x0.4", da 110mm/4.3" fino a 3010mm/119" con un passo di 100mm/3.9".

cablato con sorgente elettronica lineare con limitatore di corrente integrato da 3000K Ra95 13W/m, predisposto all'estremità con connettore amp2 maschio e femmina.

alimentatore 120-277V in tensione costante 24Vdc escluso, da installare remoto. finiture: argento opaco.

damp location rated wall and ceiling light fitting for indoor use. made of extruded oxidised aluminium with flat section, provided with a curved extruded polycarbonate diffuser. provided springs must be used for wall installation.

sizes: 17.5x11mm/0.6x0.4" section, from 110mm/4.3" up to 3010mm/119" with a 100mm/3.9" pitch.

wired with a 3000K Ra95 13W/m linear led source and an integrated current limiter, fitted with a male and female amp2 connector to the end. 24Vdc constant voltage 120-277V power supply not included, to be installed remotely. finishes: matt silver.





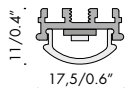
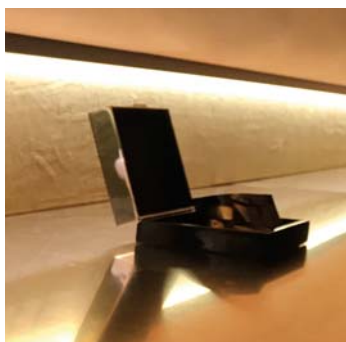
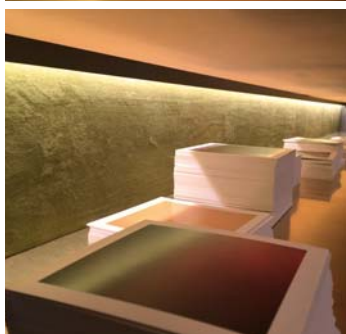
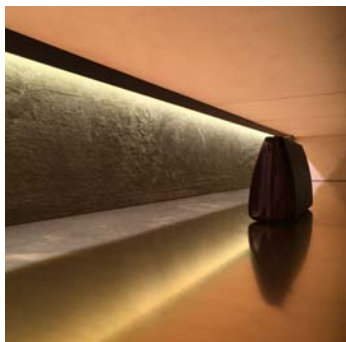

arcoled	24Vdc	ⓧ	damp	⚠	Ⓜ	i
Vb6.218.01	argento opaco · matt silver	3000K	1,3W	110mm 4.3"	0,04kg 0.09lb	
Vb6.218.02	argento opaco · matt silver	3000K	2,6W	210mm 8.3"	0,07kg 0.1lb	
Vb6.218.03	argento opaco · matt silver	3000K	3,9W	310mm 12.2"	0,1kg 0.2lb	
Vb6.218.04	argento opaco · matt silver	3000K	5,2W	410mm 16.1"	0,1kg 0.2lb	
Vb6.218.05	argento opaco · matt silver	3000K	6,5W	510mm 20.1"	0,2kg 0.4lb	
Vb6.218.06	argento opaco · matt silver	3000K	7,8W	610mm 24"	0,2kg 0.4lb	
Vb6.218.07	argento opaco · matt silver	3000K	9,1W	710mm 28"	0,2kg 0.4lb	
Vb6.218.08	argento opaco · matt silver	3000K	10,4W	810mm 31.9"	0,3kg 0.6lb	
Vb6.218.09	argento opaco · matt silver	3000K	11,7W	910mm 35.8"	0,3kg 0.7lb	
Vb6.218.10	argento opaco · matt silver	3000K	13W	1010mm 39.8"	0,3kg 0.7lb	
Vb6.218.11	argento opaco · matt silver	3000K	14,3W	1110mm 43.7"	0,4kg 0.8lb	
Vb6.218.12	argento opaco · matt silver	3000K	15,6W	1210mm 47.6"	0,4kg 0.8lb	
Vb6.218.13	argento opaco · matt silver	3000K	16,9W	1310mm 51.6"	0,4kg 0.8lb	
Vb6.218.14	argento opaco · matt silver	3000K	18,2W	1410mm 55.5"	0,5kg 1.1lb	
Vb6.218.15	argento opaco · matt silver	3000K	19,5W	1510mm 59.4"	0,5kg 1.1lb	

Ra	R9	ies tm/30		sdc	Vf	lm/m	W/m	lm/W	Ⓜ
95	90	Rf 93	Rg 102	step 2	24	1250	13	96	A+
V0001	5,9	Ta25 °C		vita media · average life	50000 h	L80	B10		

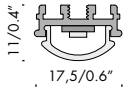

Vb6.218.16	argento opaco · matt silver	3000K	20,8W	1610mm 63.4"	0,5kg 1.1lb
Vb6.218.17	argento opaco · matt silver	3000K	22,1W	1710mm 67.3"	0,6kg 1.3lb
Vb6.218.18	argento opaco · matt silver	3000K	23,4W	1810mm 71.3"	0,6kg 1.3lb
Vb6.218.19	argento opaco · matt silver	3000K	24,7W	1910mm 75.2"	0,6kg 1.3lb
Vb6.218.20	argento opaco · matt silver	3000K	26W	2010mm 79.1"	0,7kg 1.5lb
Vb6.218.21	argento opaco · matt silver	3000K	27,3W	2110mm 83.1"	0,7kg 1.5lb
Vb6.218.22	argento opaco · matt silver	3000K	28,6W	2210mm 87"	0,7kg 1.5lb
Vb6.218.23	argento opaco · matt silver	3000K	29,9W	2310mm 90.9"	0,7kg 1.5lb
Vb6.218.24	argento opaco · matt silver	3000K	31,2W	2410mm 94.9"	0,8kg 1.7lb
Vb6.218.25	argento opaco · matt silver	3000K	32,5W	2510mm 98.8"	0,8kg 1.7lb
Vb6.218.26	argento opaco · matt silver	3000K	33,8W	2610mm 103"	0,9kg 1.9lb
Vb6.218.27	argento opaco · matt silver	3000K	35,1W	2710mm 107"	0,9kg 1.9lb
Vb6.218.28	argento opaco · matt silver	3000K	36,4W	2810mm 111"	0,9kg 1.9lb
Vb6.218.29	argento opaco · matt silver	3000K	37,7W	2910mm 115"	0,9kg 1.9lb
Vb6.218.30	argento opaco · matt silver	3000K	39W	3010mm 119"	1kg 2.2lb

Ra	R9	ies tm/30		sdcn	Vf	lm/m	W/m	lm/W	
95	90	Rf 93	Rg 102	step 2	24	1250	13	96	A+
V0001	5,9	Ta25 °C		vita media · average life	50000 h	L80	B10		

cavi con connettore femmina amp2. cables with amp2 female connector.



f9.204.90

150mm
5.9" 0,01kg
0.02lb



cavi con connettori m/f amp2. cables with m/f amp2 connectors.



f9.204.91

2000mm
78.7" 0,3kg
0.07lb

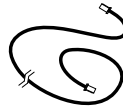

alimentatori. power supplies.

120-277V



damp



t4.630.u

24V dimm. 0-10V 96W 0,8kg
1.8lb

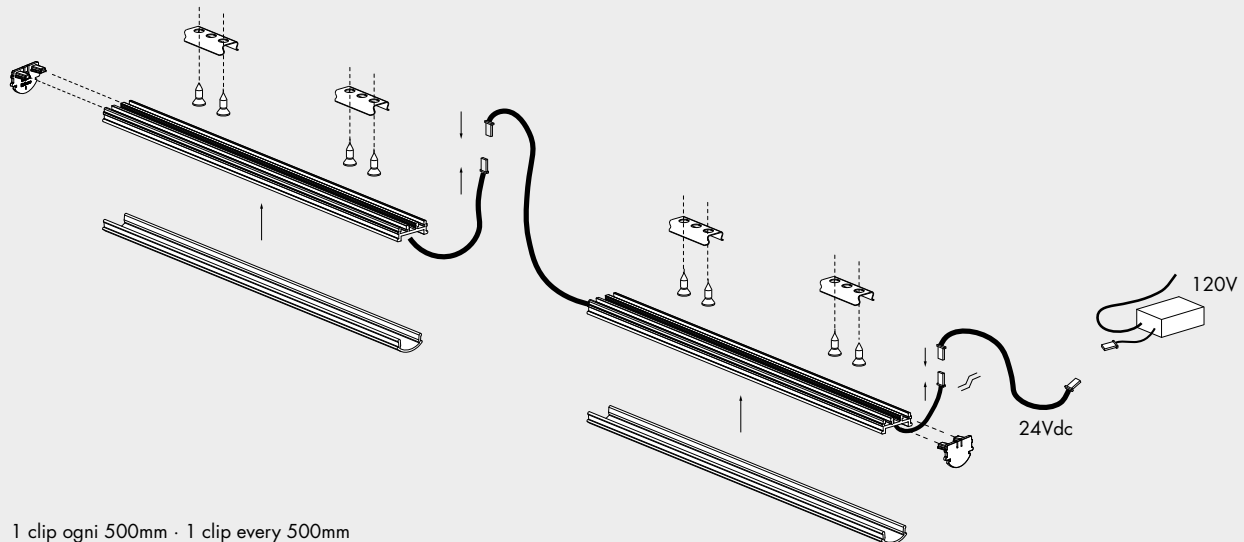
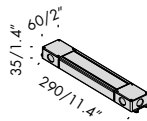

1 clip ogni 500mm · 1 clip every 500mm

