

Viabizzuno progettiamo la luce

Viabizzuno strada principale della frazione di bizzuno in provincia di ravenna dove tra la casa del popolo e la parrocchia, al n°17, sono nato il ventuno luglio millenovecentocinquantacinque. da qui nasce il nome della fabbrica di produzione fondata nel millenovecentonovantaquattro rappresentata da uno spazio bianco attraversato da due linee. una verticale, rigorosa, essenziale, equilibrata: la luce per la luce; ed una inclinata, irriverente nello spazio, ironica, fuori dagli schemi: la luce per la forma. distinte ma complementari si fondono in un unico nome: Viabizzuno.

Viabizzuno is the name of the main road of the small village bizzuno located in the province of ravenna, where I was born on the 21 07 1955 at n°17, between the 'casa del popolo' and the local parish church. from here the name of the factory founded in nineteen ninety-four represented by a white space intersected by two lines. one vertical, well balanced, logical, essential: the light for the light. the other one dynamic, irreverent, ironic: the light for the form. separate and yet complementary they cast in the same name: Viabizzuno. mario nanni

*i progetti rendono gli oggetti eterni,
le mode li corrompono, gli imbecilli li copiano
e li vendono agli ignoranti e ai deficienti.
noi progettiamo e lavoriamo per aiutare la luce
ad emozionarvi.*

*i frutti delle nostre idee e dei nostri progetti
sono protetti da brevetti
e/o modelli registrati
e/o da diritto d'autore.*

*design makes objects timeless,
fashion corrupts them,
fools copy them and sell them to
ignorants and idiots.
we do projects and work to help light to bring
you true emotion.
the results of our ideas and our projects
are protected by patents
and/or registered models
and/or copyright.*

al fine di offrire ai nostri clienti la massima qualità della luce utilizzando le più avanzate tecnologie, forti del nostro sapere artigiano costruito in Italia, aggiorniamo costantemente i nostri apparecchi di illuminazione.

Viabizzuno si riserva il diritto di apportare ai propri modelli, senza nessun preavviso, qualsiasi modifica ritenesse opportuna. per dimensioni e codici fanno fede i nostri strumenti di lavoro www.Viabizzuno.com, [Viacommerce@](mailto:Viacommerce@Viabizzuno.com), [Viabizzunoapplight](http://Viabizzunoapplight.com) e [Viabizzunoonline](http://Viabizzunoonline.com). la progettazione degli apparecchi di illuminazione e dei relativi componenti è eseguita utilizzando i millimetri come unità di misura. le dimensioni espresse in pollici sono indicative e frutto di conversioni soggette a tolleranze.

in order to provide to our customers the maximum quality of light using the most advanced technologies, being strong of our artisan knowledge made in Italy, we constantly update our lighting fixtures.

Viabizzuno reserves the right to make any modification, considered worthwhile, to its own models, without any notification. for valid dimensions and codes please consult our working tools www.Viabizzuno.com, [Viacommerce@](mailto:Viacommerce@Viabizzuno.com), [Viabizzunoapplight](http://Viabizzunoapplight.com) and [Viabizzunoonline](http://Viabizzunoonline.com). when designing lighting fixtures and related components, the unit of measure used is the millimetre. dimensions expressed in inches are indicative and are the result of conversions subject to tolerances.

legenda simboli symbols legenda



prodotto in conformità con le direttive nord americane sui soffioni doccia · produced in compliance with showerheads northamerican directives



componente certificato per il mercato nord americano idoneo ad essere utilizzato e valutato come parte di un sistema più complesso
component approved for north american market and suitable to be used and approved as part of a more complex system



prodotto finito idoneo per essere commercializzato nel mercato nord americano · listed product suitable for the north american market



prodotto finito idoneo per essere commercializzato nel mercato nord americano · listed product suitable for the north american market



pending

apparecchio di illuminazione in corso di certificazione per essere commercializzato nel mercato nord americano
light fitting undergoing certification to be marketed in the north american market

wet

prodotto classificato per uso esterno · product classified for outdoor use

damp

prodotto classificato per uso interno in ambienti umidi (bagno, sauna, ecc..) · product classified for indoor use in damp environments (bathrooms, saunas, etc.)

dry

prodotto classificato per uso interno in ambienti asciutti · product classified for indoor use in dry environments

type ic

apparecchio di illuminazione ad incasso progettato per funzionare a contatto con materiale isolante.
recessed luminaire designed to work in contact with thermal insulation.

type non-ic

apparecchio di illuminazione ad incasso progettato per funzionare in intercapedini che abbiano una certa distanza da materiali isolanti.
recessed luminaire designed to work in cavities that have a minimum dimensions and spacings to thermal insulation.

title24

prodotto conforme allo standard title24 · product compliant with title24 standard



vetro opalino · opal glass



vetro sabbiato · sanded glass



vetro nero fumè · black smoke glass



vetro trasparente · transparent glass



vetro bianco latte · white milk glass



crystallo · crystal



policarbonato opalino · opal polycarbonate diffuser



carrabile · drive over

a

fascio asimmetrico · asymmetric beam

e

fascio ellittico · elliptical beam

w

wallwasher

- A** alimentatore incluso · power supply included
- A** alimentatore escluso · power supply not included
- AR** alimentatore remoto incluso · remote power supply included
- Ai** alimentatore elettronico con controllo intelligente incluso · electronic power supply with smart control included
- AiR** alimentatore elettronico con controllo intelligente incluso, da installare remoto · electronic power supply with smart control included, to be installed remotely
- AS** alimentatore a spina incluso · plug power supply included
- T** trasformatore incluso · transformer included
- K** kit di cablaggio incluso · wiring kit not included
- K** kit di cablaggio escluso · wiring kit not included
- L** lampadina con sorgente elettronica led, ad incandescenza, alogena o fluorescente inclusa.
bulb with led electronic source, incandescent, halogen or fluorescent included.
- L** lampadina con sorgente elettronica led, ad incandescenza, alogena o fluorescente esclusa.
bulb with led electronic source, incandescent, halogen or fluorescent not included.
- pr** propulsore dinamico n55 incluso · included
-  attenzione: sorgente luminosa led. non guardare mai direttamente a occhio nudo · attention: led light source. never look straight without eye protection
- i** peso netto · net weight (kg)
- ⚡⚡⚡** possibilità di combinazione tra interfaccia n55, propulsore dinamico n55 e lampadina n55 · possible combination between n55 interface, propulsore dinamico n55 and n55 bulb
- l.d.** luce diretta · direct light
- l.i.** luce indiretta · indirect light
- V** disponibile su · available on *Viabizzuno applight* www.Viabizzuno.com *Viabizzuno online*



brevettato · patented



apparecchio di illuminazione a soffitto o scomparsa totale con erogatore d'acqua integrato.

realizzato in acciaio inox 316L lucidato, erogatore d'acqua con raccordi 1/2", tubi idraulici non forniti.

modelli:

cubo doccia 155x155mm/6.1x6.1" h.47/1.8"

senza ugelli, da utilizzare con acqua addolcita, o 155x155mm/6.1x6.1" h.52mm/2" con ugelli in silicone,

cubo doccia 300x155mm/11.8x6.1" h.47mm/1.9"

senza ugelli, da utilizzare con acqua addolcita, o 300x155mm/11.8x6.1" h.57mm/2.2" con ugelli in silicone.

cablati con sorgente elettronica 2700K o 3000K, 1,5W 500mA.

alimentatore 120-277V 50-60Hz escluso, da installare remoto.

accessori: innesto rapido con valvola di ritegno,

limitatore di portata 9L/min 2.3U.S. gal/min,

limitatore di portata 7L/min 1.8U.S. gal/min.

finiture: inox 316L lucido, idoneo anche per l'installazione in ambiente marittimo.

wet location rated ceiling or total recessed light fitting with integrated water supply.

made of polished 316L stainless steel, water supply with 1/2" fittings, hydraulic tubes not provided.

versions:

cubo doccia 155x155mm/6.1x6.1" h.47/1.9" sized

without nozzles, to be used with sweetened water, or 155x155mm/6.1x6.1" h.52mm/2" sized with silicone nozzles,

cubo doccia 300x155mm/11.8x6.1" h.52mm/2"

sized without nozzles to be used with sweetened water or 300x155mm/11.8x6.1" h.57mm/2.2" sized with silicone nozzles.

wired with 2700K or 3000K 1.5W 500mA.

120-277V 50-60Hz power supply not included, to be installed remotely.

accessories: quick coupling with check valve, 9L/min 2.2U.S. gal/min flow limiter, 7L/min 1.8U.S. gal/min flow limiter.

finishes: 316L polished stainless steel, suitable also to the installation in marine environment.

cubo doccia 155x155

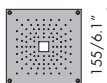

155/6.1"



155/6.1"

47/1.8"

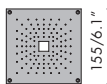

155/6.1"



155/6.1"

52/2"

f6.128.14.u inox 316L lucido con innesto rapido per acqua addolcita 1kg
polished 316L stainless with quick coupling for sweetened water 2.2lb

f6.128.14.1.u inox 316L lucido con innesto rapido con ugelli in silicone 1kg
polished 316L stainless with quick coupling with silicone nozzle 2.2lb

componenti. components.



155/6.1"

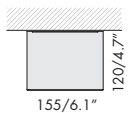

155/6.1"

120/4.7"

f6.128.12.u corpo soffitto lucido 1,2kg
polished ceiling housing 2.7lb

328/12.9"

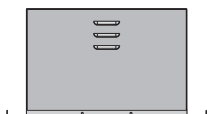

162/6.3"

241/8.8"

f6.128.13.u corpo incasso a scomparsa totale cartongesso 1,4kg
plasterboard trimless fully concealed housing 3.1lb

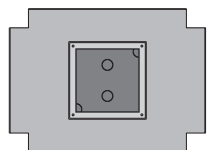

410/16.1"

300/11.8"

**installazione soffitto
ceiling installation**

creare un foro nel soffitto di 60mm/2.36" e profondo 100mm/3.94" nel caso si utilizzi l'innesto rapido standard (opzione 1) o profondo 150mm/5.91" nel caso si utilizzi l'innesto rapido con valvola di ritegno (opzione 2 con accessorio f9.128.91). far uscire da esso il cavo di alimentazione 500mA e il tubo, rigorosamente flessibile, dell'acqua. make a 60mm/2.36" hole in the ceiling with 100mm/3.94" deep if the standard quick coupling is used (option 1) or 150mm/5.91" deep if the quick coupling with check valve (option 2 with accessory f9.128.91) is used. pull the 500mA power cable and, strictly flexible, water pipe through it.

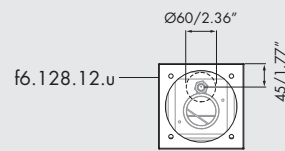

opzione - option 1

Ø60/2.36"

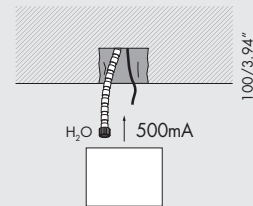

opzione - option 2

Ø60/2.36"

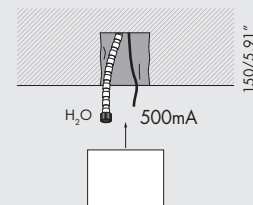

installazione soffitto · ceiling installation

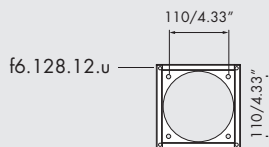

interasse fori di installazione · installation hole distance

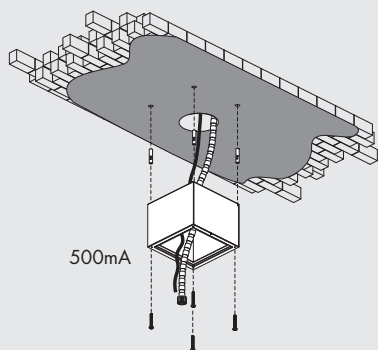

fissare il corpo con viti e tasselli adatti
fasten the body with the suitable dowels and screws

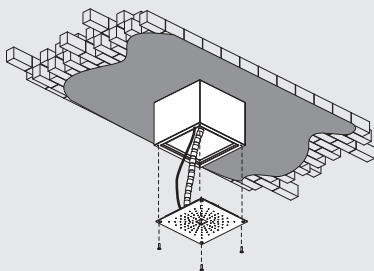

installazione a scomparsa totale per cartongesso
completely recessed installation for plasterboard

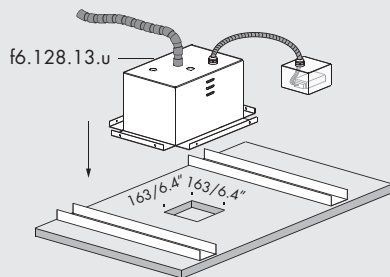

dimensioni foro per cartongesso
cut-out dimensions for installation in plasterboard

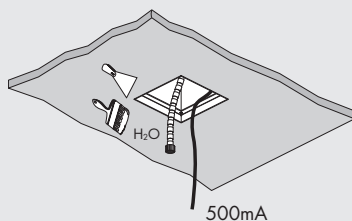

fissare il corpo con viti e tasselli adatti
fasten the body with the suitable dowels and screws

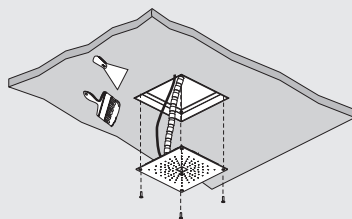

distanza minima controsoffitto
minimum false ceiling distance



senza valvola di ritegno · without check valve

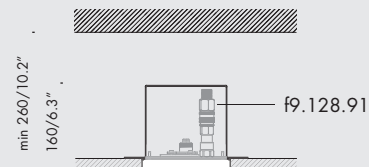

con valvola di ritegno · with check valve f9.128.91



installazione soffitto
ceiling installation

creare un foro nel soffitto di 60mm/2.36" e profondo 100mm/3.94" nel caso si utilizzi l'innesto rapido standard (opzione 1) o 150mm/5.91" nel caso si utilizzi l'innesto rapido con valvola di sicurezza (opzione 2 con accessorio f9.128.91). far uscire da esso il cavo di alimentazione 500mA e il tubo, rigorosamente flessibile, dell'acqua. make a 60mm/2.36" hole in the ceiling with 100mm/3.94" deep if the standard quick coupling is used (option 1) or 150mm/5.91" deep if the quick coupling with safety valve (option 2 with accessory f9.128.91) is used. pull the 500mA power cable and, strictly flexible, water hose through it.

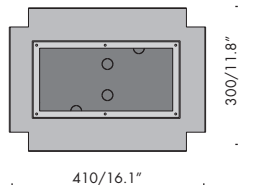
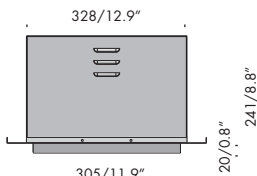
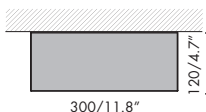
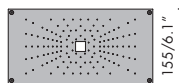
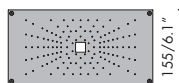
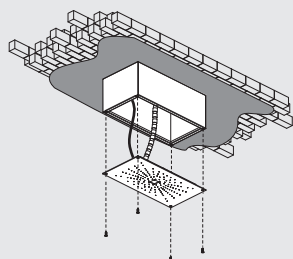
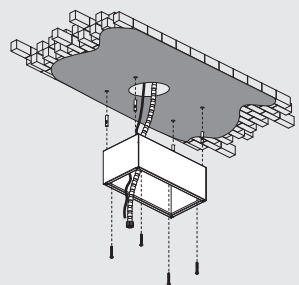
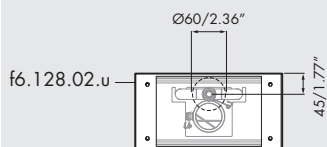

cubo doccia 155x300



f6.128.04.u inox 316L lucido con innesto rapido per acqua addolcita 1,6kg
polished 316L stainless with quick coupling for sweetened water 3.5lb

f6.128.04.1.u inox 316L lucido con innesto rapido con ugelli in silicone 1,6kg
polished 316L stainless with quick coupling with silicone nozzle 3.5lb

componenti. components.



f6.128.02.u corpo soffitto lucido 1kg
polished ceiling housing 2.2lb

f6.128.03.u corpo incasso a scomparsa totale cartongesso 1,4kg
plasterboard trimless fully concealed housing 3.1lb

installazione a scomparsa totale
per cartongesso
completely recessed installation
for plasterboard

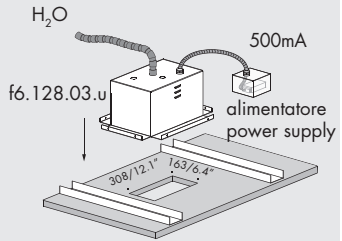

dimensioni foro per cartongesso
cut-out dimensions for installation
in plasterboard

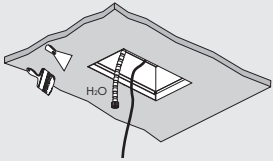

stuccare rasare e verniciare
point, skim and paint

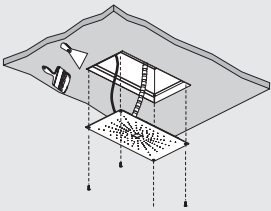

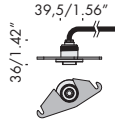

kit **500mA** **wet**

Vb9.128.05.27.u 2700K 0,3kg
0.7lb

Ra	ies tm-30		sdc	mA	V _{f (min)}	lm	W	lm/W	
90	Rf 90	Rg 100	step 2	500	2,9	90	1,5	60	A++
ca000	les2	Ta25 °C	vita media · average life			50000 h	L80	B10	

Vb9.128.05.30.u 3000K 0,3kg
0.7lb

Ra	ies tm-30		sdc	mA	V _{f (min)}	lm	W	lm/W	
90	Rf 90	Rg 100	step 2	500	2,9	104	1,5	69	A++
ca001	les2	Ta25 °C	vita media · average life			50000 h	L80	B10	

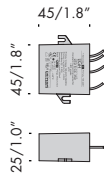

alimentatori. power supplies. **120-277V 50-60Hz** **damp**

t4.306.u 500mA 2±13V 0,09kg
0.2lb

accessori. accessories.



f9.128.91 innesto rapido con valvola di ritegno
quick coupling with check valve 0,1kg
0.2lb



f9.128.93 limitatore di portata
capacity limiter 9 L/min 0,1kg
2.3 U.S. gal/min 0.2lb



f9.128.94 limitatore di portata
capacity limiter 7 L/min 0,1kg
1.8 U.S. gal/min 0.2lb

pressione · pressure	portata L/min · flux U.S. gal	
1 bar	16 L/min	4.2 U.S. gal
1,5 bar	20 L/min	5.3 U.S. gal
2 bar	24 L/min	6.3 U.S. gal

