



Viabizzuno strada principale della frazione di bizzuno in provincia di ravenna dove tra la casa del popolo e la parrocchia, al n°17, sono nato il ventuno luglio millenovecentocinquantacinque. da qui nasce il nome della fabbrica di produzione fondata nel millenovecentonovantaquattro rappresentata da uno spazio bianco attraversato da due linee. una verticale, rigorosa, essenziale, equilibrata: la luce per la luce; ed una inclinata, irriverente nello spazio, ironica, fuori dagli schemi: la luce per la forma. distinte ma complementari si fondono in un unico nome: Viabizzuno.

marionanni

Viabizzuno is the name of the main road of the small village bizzuno located in the province of ravenna, where I was born on the twenty-first july nineteenfiftyfive at n°17, between the 'casa del popolo' and the local parish church. from here the name of the factory founded in nineteen ninety-four represented by a white space intersected by two lines. one vertical, well balanced, logical, essential: the light for the light. the other one dynamic, irreverent, ironic: the light for the form. separate and yet complementary they cast in the same name: Viabizzuno.

prodotto
product



schede tecniche
technical data sheets



curve fotometriche
photometric curves



modelli 3d per i tuoi render
3d models for your render



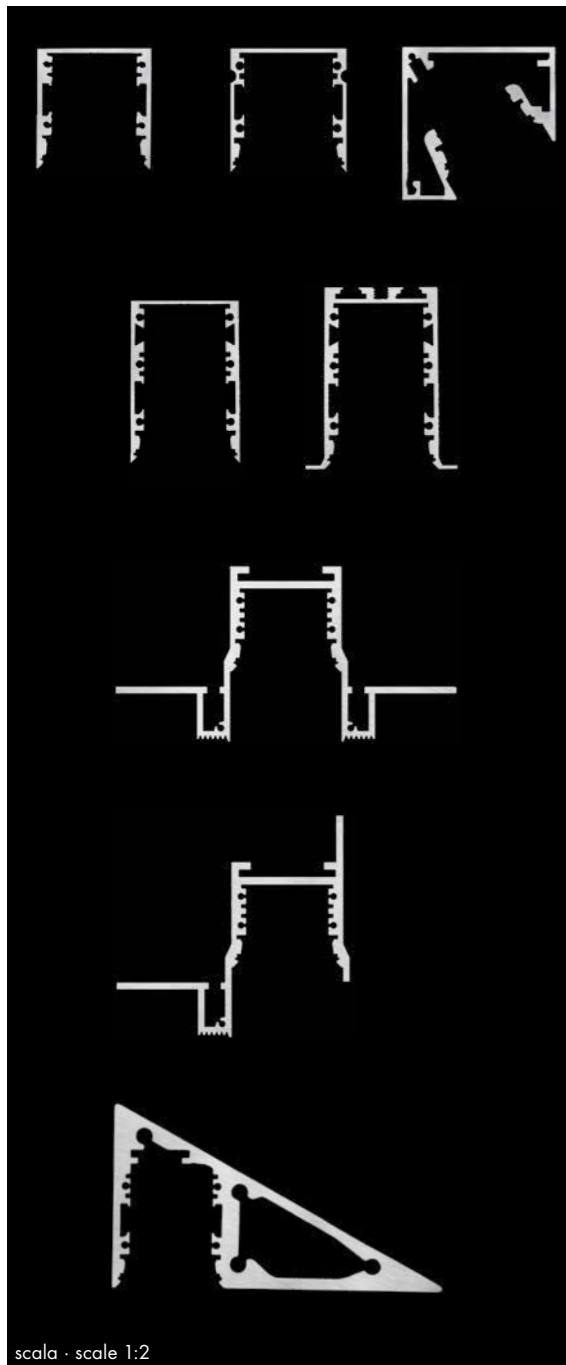

scala · scale 1:2

sistema modulare per interni e per esterni.
realizzato in alluminio estruso, ossidato e verniciato a polvere, disponibile nelle varianti configurate o da configurare a propria scelta.

modelli:

c2 30x32 parete soffitto,

ck 30x32,

c1 30x48 parete soffitto sospensione,

c1 40x48 incasso,

ca 42x42 parete soffitto,

c 16.64,

css 92x48 scomparsa totale,

csr 60x68 scomparsa totale radente.

ogni profilo vuoto può essere tagliato alla lunghezza desiderata e si possono installare su di esso i seguenti kit di cablaggio elettrico: kit con sorgente elettronica lineare e diffusore in policarbonato satinato, kit con sorgente elettronica lineare e diffusore in policarbonato satinato h.5mm/0.2", kit con sorgente elettronica lineare e diffusore prismato, kit con sorgente elettronica lineare e lente ellittica in policarbonato, kit micromen 36,8x30x120mm/1.5x1.2x4.9" cablato con sorgente elettronica 2700K e 3000K 2x1W fino a 2x90lm, kit vangogh 42x30x125mm/1.6x1.2x4.9" cablato con sorgente elettronica 2700K e 3000K les6 2x2,2W fino a 2x214lm, kit trentotto diametro Ø38mm/1.5" 60x250mm/2.4x9.8" cablato con sorgente elettronica 2700K e 3000K 6W 19° e 41° fino a 544lm, kit ecomini diametro Ø55mm/2.2" 69x250mm/2.7x9.8" cablato con sorgente elettronica 2700K e 3000K 12,4W 13° e 12,7W 19° 36° con dimmer incluso.

tutti i kit elettrici sono alimentati in tensione costante 24Vdc, alimentatore escluso.
accessori: tappi di chiusura laterale, coperchio cieco c sistema, giunti lineari, pulsante, raccordi, agganci orientabili per sistemi integrati, alimentatore 120V/24Vdc, kit di sospensione, supporti sorgenti elettroniche.

finiture: profili, kit micromen, kit vangogh, kit trentotto, kit ecomini argento opaco, bianco V e nero55, c2 30x32 grigio argento.

damp location rated modular system for indoor or outdoor use.
made of powder and painted oxidised extruded aluminium, available in the configured version or to custom at user's discretion.

versions:

c2 30x32 wall and ceiling version,

ck 30x32,

c1 30x48 wall, ceiling and suspension version,

c1 40x48 recessed,

ca 42x42 wall and ceiling version,

c 16.64;

css 92x48 fully concealed version;











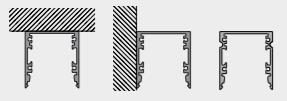







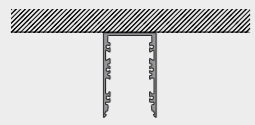







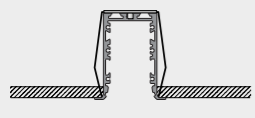







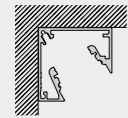







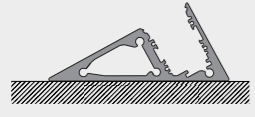

csr 60x68 fully concealed grazing version.

each hollow profile can be cutted to the desired length and is suitable to accommodate the following electrical wiring kits: kit with linear led source and frosted polycarbonate diffuser, kit with linear led source and h.5mm/0.2" frosted polycarbonate diffuser, kit with linear led source and prismatic polycarbonate diffuser, kit with linear led source and polycarbonate elliptical lens, micromen spotlight kit 36,8x30x120mm/1.5x1.2x4.9" wired with 2700K and 3000K 2x1W up to 2x90lm led source, vangogh spotlight kit 42x30x125mm/1.6x1.2x4.9" wired with 2700K and 3000K les6 2x2,2W 2x214lm, trentotto spotlight kit diameter Ø38mm/1.5" 60x250mm/2.4x9.8" wired with 2700K and 3000K 6W 19° and 41° up to 544lm led source, ecomini spotlight kit with diameter Ø55mm/2.2" 69x250mm/2.7x9.8" wired with 2700K and 3000K 12.4W 13° and 12.7W 19° 31° led source with dimmer.

all the electrical kits are powered with 24Vdc constant voltage, power supply not included.
accessories: lateral end caps, c sistema blind lid, linear joints, push-button, various fittings, adjustable hooks for integrated systems, 120V/24Vdc power supply, suspension kit, led sources supports.

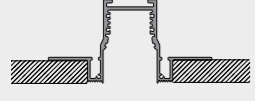
finishes: profiles, vangogh spotlight kit, trentotto kit, ecomini spotlight kit matt silver, bianco V and nero55, c2 30x32 silver grey.

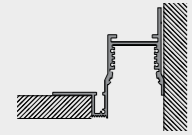

c sistema	kit lineare diffusore satinato frosted diffuser	kit lineare diffusore satinato frosted diffuser5mm	kit lineare diffusore prismatico prismatic diffuser	kit lineare lente ellittica elliptical lens	kit micromen	kit vangogh	kit trentotto	kit ecomini
 <p>c2 30x32, ck 30x32 mario nanni</p>								
 <p>c1 30x48 mario nanni</p>								
 <p>c1 40x48 mario nanni</p>								
 <p>ca 42x42 mario nanni</p>								
 <p>c 16.64 vittorio longheu</p>								
 <p>css 92x48 mario nanni</p>								
 <p>csr 60x68 mario nanni</p>								



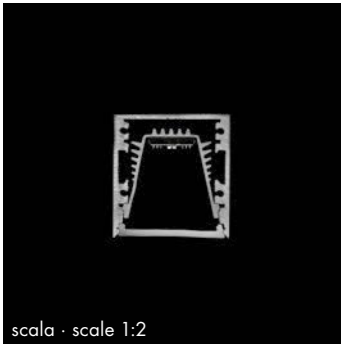

scala · scale 1:2

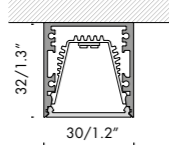

c2 30x32 24Vdc title24 damp i

Vb6.194.22	argento opaco · matt silver	3000K	14,7W	600mm 23.6"	0,7kg 1.5lb
Vb6.194.22.1	bianco V	3000K	14,7W	600mm 23.6"	0,7kg 1.5lb
Vb6.194.23	argento opaco · matt silver	3000K	22,5W	900mm 35.4"	1kg 2.2lb
Vb6.194.23.1	bianco V	3000K	22,5W	900mm 35.4"	1kg 2.2lb
Vb6.194.24	argento opaco · matt silver	3000K	30,3W	1200mm 47.2"	1,3kg 2.9lb
Vb6.194.24.1	bianco V	3000K	30,3W	1200mm 47.2"	1,3kg 2.9lb
Vb6.194.25	argento opaco · matt silver	3000K	38,1W	1500mm 59.1"	1,6kg 3.5lb
Vb6.194.25.1	bianco V	3000K	38,1W	1500mm 59.1"	1,6kg 3.5lb

Ra	R9	ies tm-30		sdcm	V _f	lm/m	W/m	lm/W
95	90	Rf 93	Rg 102	step 2	24	2500	26	96
V3001	11 		Ta25 °C	vita media · average life	50000 h	L80	B10	

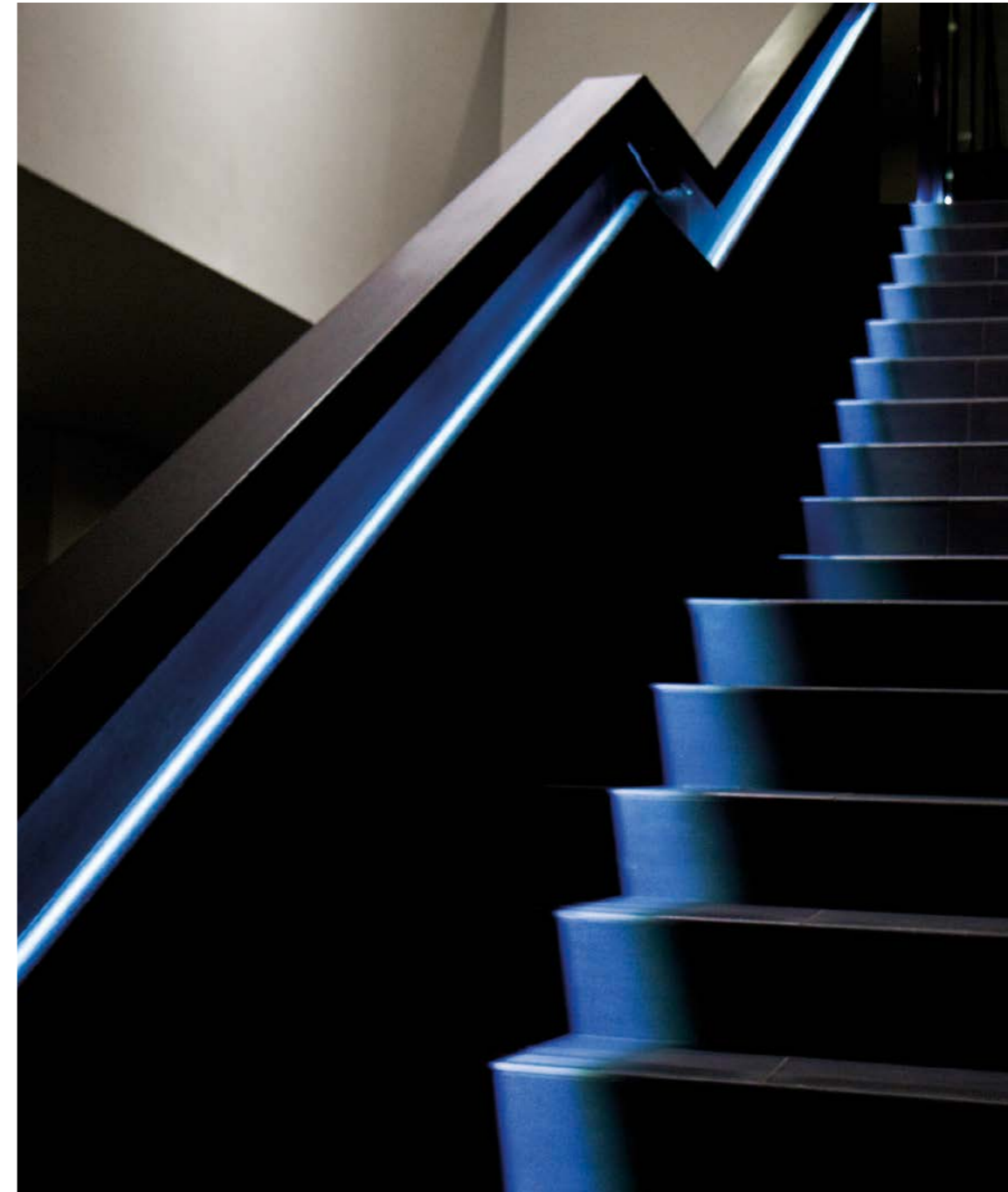

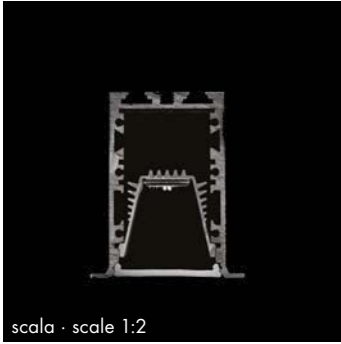

scala · scale 1:2

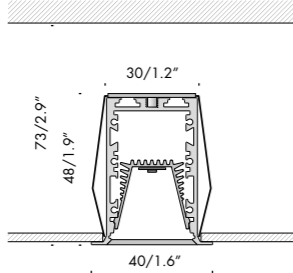

c1 40x48 24Vdc title24 damp

Vb6.193.22	argento opaco · matt silver	3000K	14,7W	600mm 23.6"	0,7kg 1.5lb
Vb6.193.22.1	bianco V	3000K	14,7W	600mm 23.6"	0,7kg 1.5lb
Vb6.193.23	argento opaco · matt silver	3000K	22,5W	900mm 35.4"	1kg 2.2lb
Vb6.193.23.1	bianco V	3000K	22,5W	900mm 35.4"	1kg 2.2lb
Vb6.193.24	argento opaco · matt silver	3000K	30,3W	1200mm 47.2"	1,3kg 2.9lb
Vb6.193.24.1	bianco V	3000K	30,3W	1200mm 47.2"	1,3kg 2.9lb
Vb6.193.25	argento opaco · matt silver	3000K	38,1W	1500mm 59.1"	1,6kg 3.5lb
Vb6.193.25.1	bianco V	3000K	38,1W	1500mm 59.1"	1,6kg 3.5lb

Ra	R9	ies tm-30		sdc	V _f	lm/m	W/m	lm/W
95	90	Rf 93	Rg 102	step 2	24	2500	26	96
V3001	11		Ta25 °C	vita media · average life	50000 h	L80	B10	



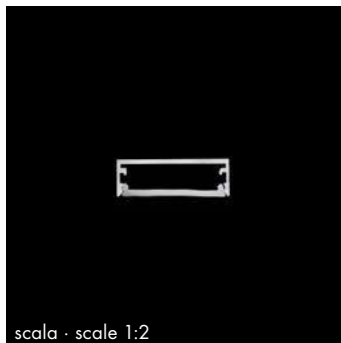

scala · scale 1:2

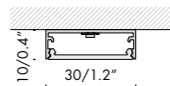

c3 10x30		24Vdc	title24	damp		
f6.209.06	argento opaco · matt silver	3000K	7,8W	620mm 24.4"	0,7kg 1.5lb	
f6.209.06.1	bianco V	3000K	7,8W	620mm 24.4"	0,7kg 1.5lb	
f6.209.09	argento opaco · matt silver	3000K	11,7W	920mm 36.2"	1kg 2.2lb	
f6.209.09.1	bianco V	3000K	11,7W	920mm 36.2"	1kg 2.2lb	
f6.209.12	argento opaco · matt silver	3000K	15,6W	1220mm 48"	1,3kg 2.9lb	
f6.209.12.1	bianco V	3000K	15,6W	1220mm 48"	1,3kg 2.9lb	
f6.209.15	argento opaco · matt silver	3000K	19,5W	1520mm 60"	1,6kg 3.5lb	
f6.209.15.1	bianco V	3000K	19,5W	1520mm 60"	1,6kg 3.5lb	

Ra	R9	ies tm/30		sdcm	Vf	lm/m	W/m	lm/W
95	90	Rf 93	Rg 102	step 2	24	1250	13	96
V0001	5,9	Ta25 °C		vita media · average life	50000 h	L80	B10	

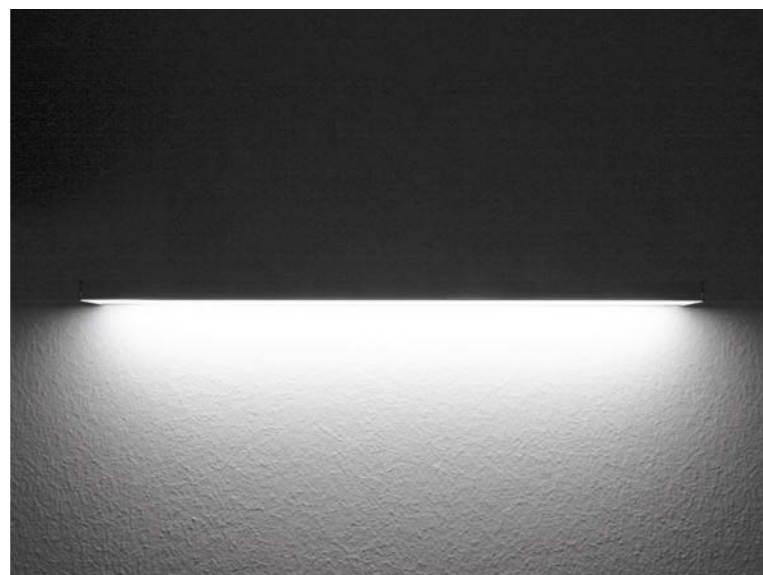

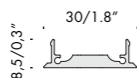
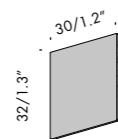
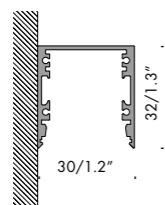
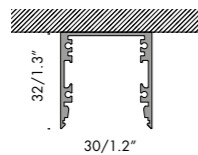
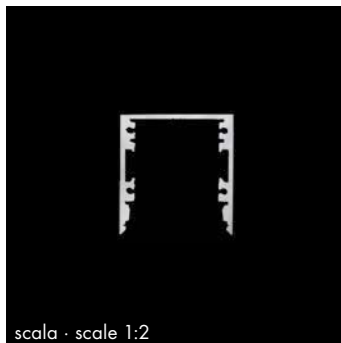

c2 30x32			
Vb6.194.61	argento opaco · matt silver	3000mm 118.1"	2,3kg 5lb
Vb6.194.62.1	bianco V	3000mm 118.1"	2,3kg 5lb
Vb6.194.65	nero55	3000mm 118.1"	2,3kg 5lb

c2 30x32 radente			
Vb6.194.71	argento opaco · matt silver	3000mm 118.1"	2,3kg 5lb
Vb6.194.72	bianco V	3000mm 118.1"	2,3kg 5lb
Vb6.194.75	nero55	3000mm 118.1"	2,3kg 5lb

tappi terminali. end caps.			
f9.194.81	argento opaco · matt silver	2 pz · pcs	0,1kg 0.2lb
f9.194.82	bianco V	2 pz · pcs	0,1kg 0.2lb
f9.130.89	nero55	2 pz · pcs	0,1kg 0.2lb

coperchi. covers.			
Vb9.194.03	argento opaco · matt silver	3000mm 118.1"	2,3kg 5lb
Vb9.194.04	bianco V	3000mm 118.1"	2,3kg 5lb
Vb9.194.05	nero55	3000mm 118.1"	2,3kg 5lb

-  kit lineare
diffusore satinato
frosted diffuser
-  kit lineare
diffusore prismato
prismatic diffuser
-  kit lineare
lente ellittica
elliptic lens
-  kit micromen
-  kit vangogh
-  kit trentotto
-  kit ecomini

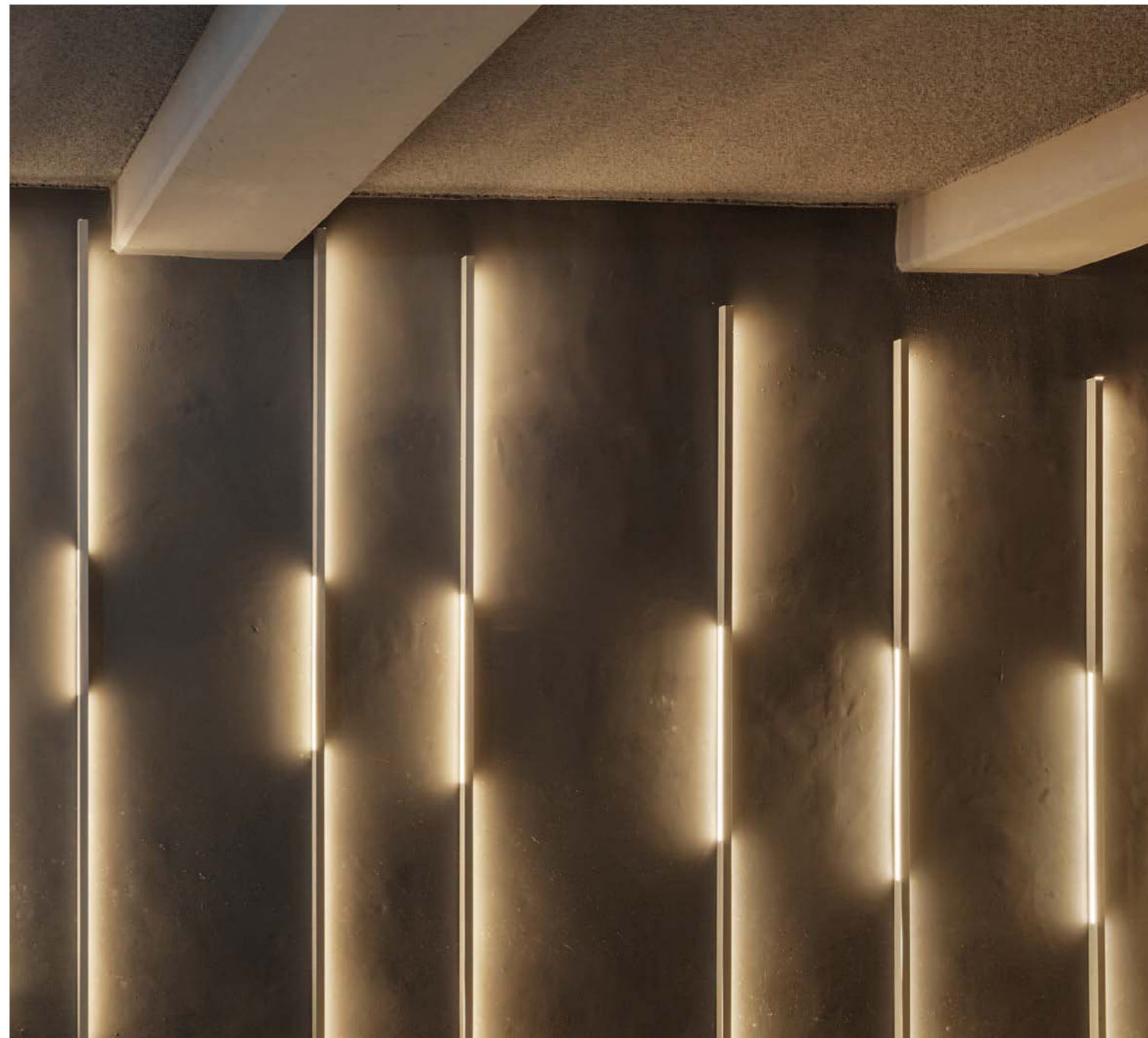

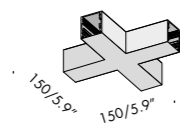
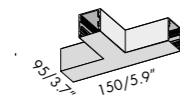
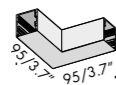
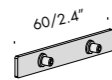
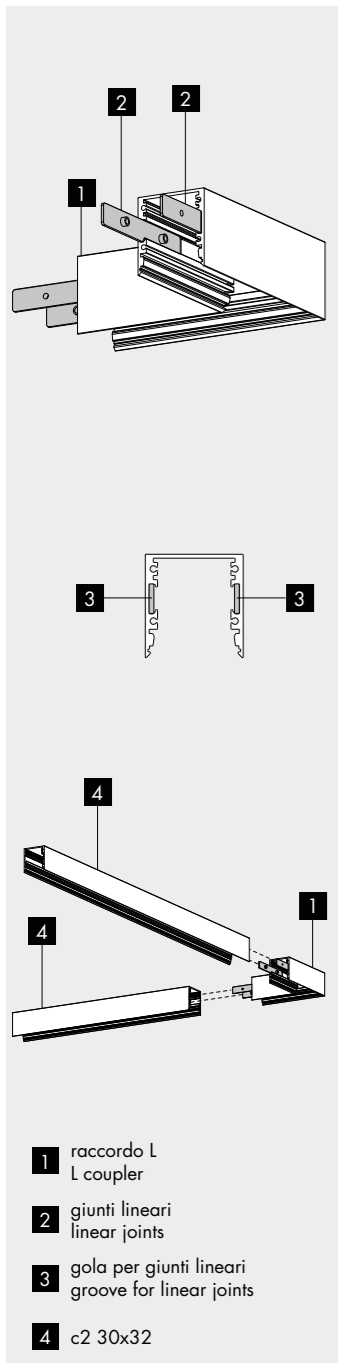

giunti. joints.

f9.131.01 lineari acciaio inox + grani
stainless steel linear + grub screws 2 pz · pcs 0,1kg
0.2lb

raccordi. couplers.

f9.130.82 raccordo L · L coupler argento opaco · matt silver 0,2kg
0.4lb

f9.130.92 raccordo L · L coupler bianco V 0,2kg
0.4lb

f9.130.86 raccordo L · L coupler nero55 0,2kg
0.4lb

f9.130.83 raccordo T · T coupler argento opaco · matt silver 0,2kg
0.4lb

f9.130.93 raccordo T · T coupler bianco V 0,2kg
0.4lb

f9.130.87 raccordo T · T coupler nero55 0,2kg
0.4lb

f9.130.84 raccordo + · + coupler argento opaco · matt silver 0,3kg
0.7lb

f9.130.94 raccordo + · + coupler bianco V 0,3kg
0.7lb

f9.130.88 raccordo + · + coupler nero55 0,3kg
0.7lb



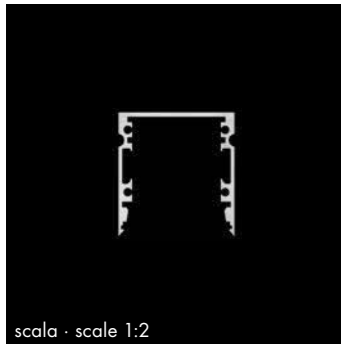

scala · scale 1:2

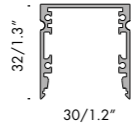

ck 30x32

Vb6.194.81	argento opaco · matt silver	3000mm 118.1"	2,3kg 5lb
Vb6.194.82	bianco V	3000mm 118.1"	2,3kg 5lb
Vb6.194.85	nero55	3000mm 118.1"	2,3kg 5lb

tappi terminali. end caps.

f9.194.81	argento opaco · matt silver	2 pz · pcs	0,1kg 0.2lb
f9.194.82	bianco V	2 pz · pcs	0,1kg 0.2lb
f9.130.89	nero55	2 pz · pcs	0,1kg 0.2lb

coperchi. covers.

Vb9.194.03	argento opaco · matt silver	3000mm 118.1"	2,3kg 5lb
Vb9.194.04	bianco V	3000mm 118.1"	2,3kg 5lb
Vb9.194.05	nero55	3000mm 118.1"	2,3kg 5lb

giunti. joints.

f9.131.01	lineari acciaio inox + grani stainless steel linear + grub screws	2 pz · pcs	0,1kg 0.2lb
------------------	--	------------	----------------

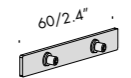
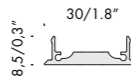
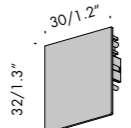

kit lineare
diffusore satinato
frosted diffuser



kit lineare
diffusore prismatico
prismatic diffuser



kit lineare
lente ellittica
elliptic lens



kit micromen



kit vangogh



kit trentotto



kit ecomini



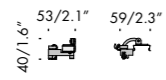

kit agganci 094/070. hooks kit. ⓘ

Vb9.094.90 agganci orientabili · adjustable hooks 2 pz · pcs 0,1kg
0.2lb



Vb9.094.91 agganci fissi · fixed hooks 2 pz · pcs 0,1kg
0.2lb



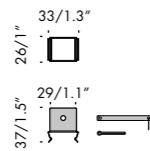

kit agganci. hooks kit. CE ⓘ

Vb9.194.86 agganci fissi per controsoffitto di doghe in lamiera 2 pz · pcs 0,1
 fixed hooks for sheet metal false ceiling

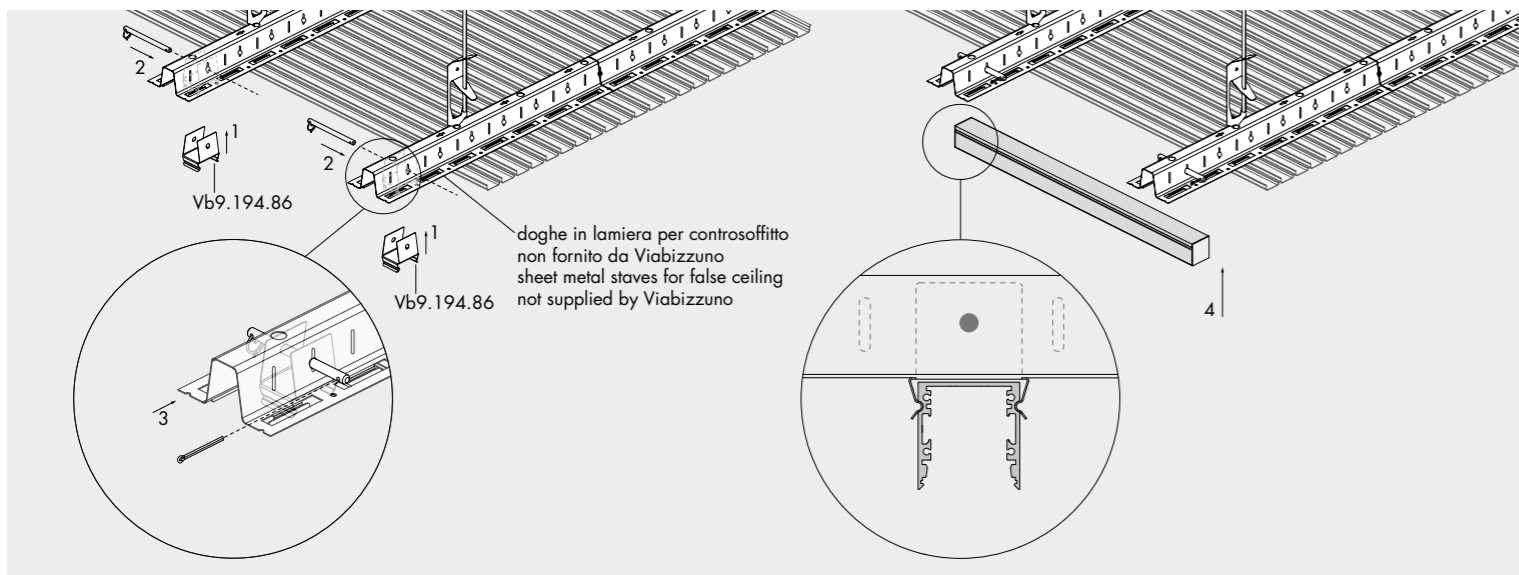

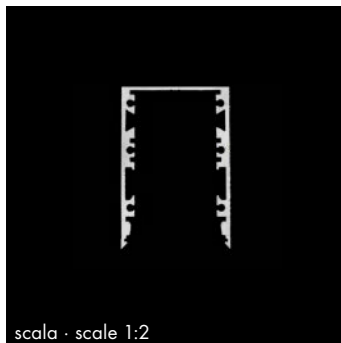

scala · scale 1:2

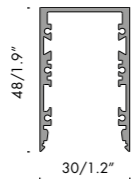

c 1 30x48			
Vb6.194.91	argento opaco · matt silver	3000mm 118.1"	2,3kg 5lb
Vb6.194.92	bianco V	3000mm 118.1"	2,3kg 5lb
Vb6.194.95	nero55	3000mm 118.1"	2,3kg 5lb

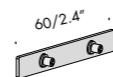
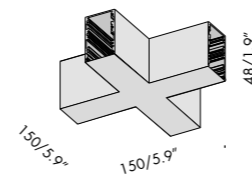
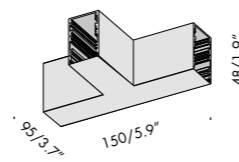
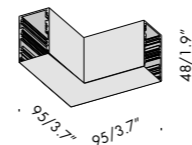
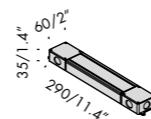

alimentatori. power supplies.	120-277V	damp		
t4.630.u	24V	dim. 0-10V	96W	0,8kg 1.8lb

raccordi. couplers.		
f9.521.01	raccordo L argento opaco · matt silver L coupler	0,2kg 0.4lb
f9.521.03	raccordo L bianco V · L coupler	0,2kg 0.4lb
f9.521.04	raccordo L nero55 · L coupler	0,2kg 0.4lb

f9.521.06	raccordo T argento opaco · matt silver T coupler	0,2kg 0.4lb
f9.521.07	raccordo T bianco V · T coupler	0,2kg 0.4lb
f9.521.08	raccordo T nero55 · T coupler	0,2kg 0.4lb

f9.521.11	raccordo + argento opaco · matt silver + coupler	0,2kg 0.4lb
f9.521.12	raccordo + bianco V · + coupler	0,2kg 0.4lb
f9.521.13	raccordo + nero55 · + coupler	0,2kg 0.4lb

giunti. joints.			
f9.131.01	lineari acciaio inox + grani stainless steel linear + grub screws	2 pz · pcs	0,1kg 0.2lb

tappi terminali. end caps.			
f9.521.81	argento opaco · matt silver	2 pz · pcs	0,1kg 0.2lb
f9.521.83	bianco V	2 pz · pcs	0,1kg 0.2lb
f9.521.82	nero55	2 pz · pcs	0,1kg 0.2lb

coperchi. covers.			
Vb9.194.03	argento opaco · matt silver	3000mm 118.1"	2,3kg 5lb
Vb9.194.04	bianco V	3000mm 118.1"	2,3kg 5lb
Vb9.194.05	nero55	3000mm 118.1"	2,3kg 5lb

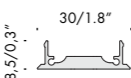
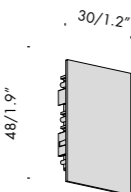

kit lineare
diffusore satinato
frosted diffuser



kit lineare
diffusore prismatico
prismatic diffuser



kit lineare
lente ellittica
elliptic lens



kit micromen



kit vangogh



kit trentotto



kit ecomini

3000/118.1"

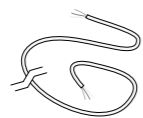

kit sospensione. suspension kit.

Vb9.194.07 cavo sospensione
suspension cable 3000mm
118.1" 1 pz · pcs 0,1kg
0.2lb

Vb9.194.08.u cavo elettrico trasparente
transparent electric cable 2x18AWG 10000mm
393" 0,5kg
1.1lb

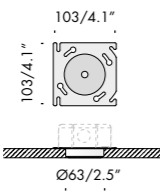

rosone a soffitto. ceiling rose.

Vb9.000.06.u scomparsa totale cartongesso
fully concealed for plasterboard installation 0,3kg
0.7lb

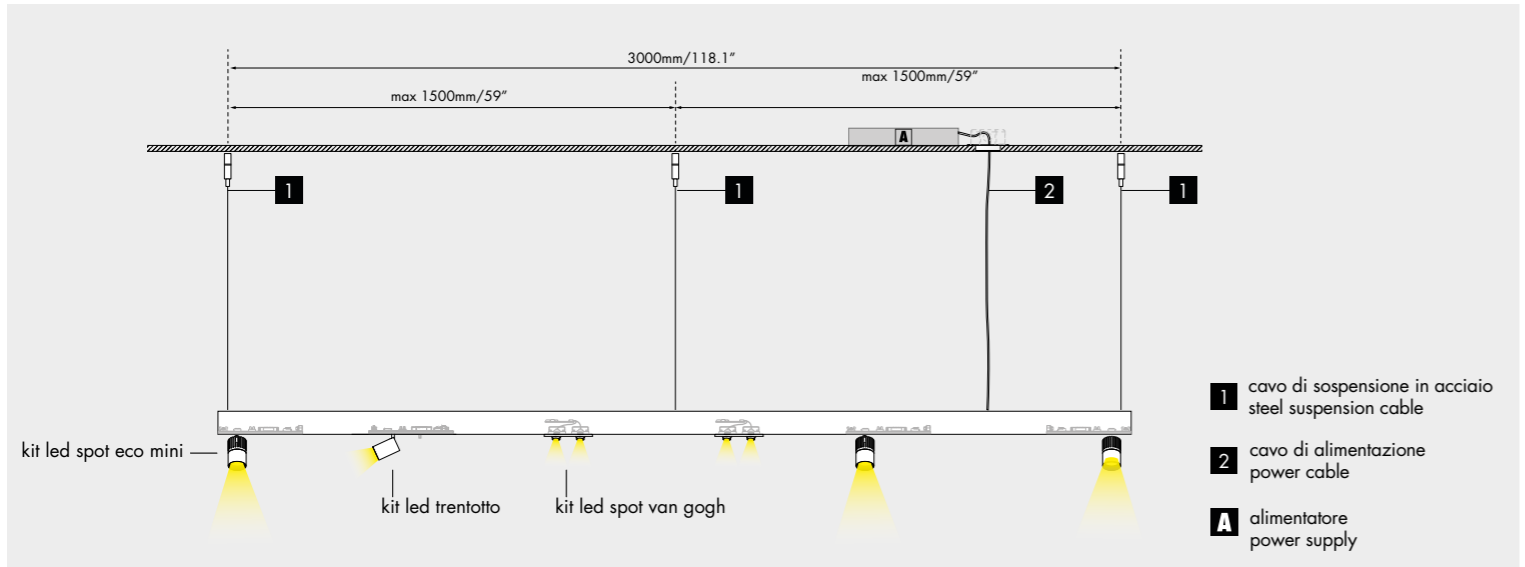

- 1** cavo di sospensione in acciaio
steel suspension cable
- 2** cavo di alimentazione
power cable
- A** alimentatore
power supply



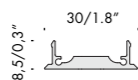
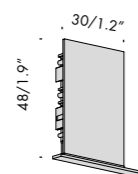
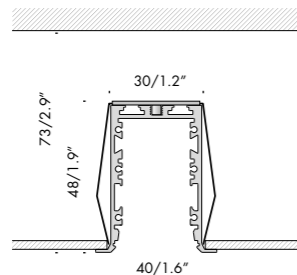
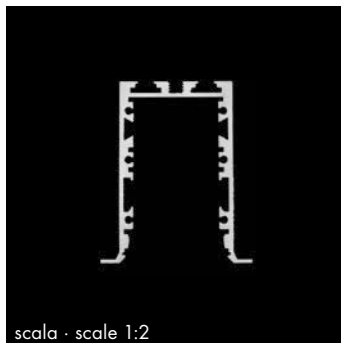

c 1 40x48		type ic	damp	
Vb6.194.101	argento opaco · matt silver	3000mm 118.1"	2,3kg 5lb	
Vb6.194.102	bianco V	3000mm 118.1"	2,3kg 5lb	
Vb6.194.105	nero55	3000mm 118.1"	2,3kg 5lb	

tappi terminali. end caps.			
f9.129.81	argento opaco · matt silver	2 pz · pcs	0,1kg 0.2lb
f9.129.95	bianco V	2 pz · pcs	0,1kg 0.2lb
f9.129.97	nero55	2 pz · pcs	0,1kg 0.2lb

coperchi. covers.			
Vb9.194.03	argento opaco · matt silver	3000mm 118.1"	2,3kg 5lb
Vb9.194.04	bianco V	3000mm 118.1"	2,3kg 5lb
Vb9.194.05	nero55	3000mm 118.1"	2,3kg 5lb

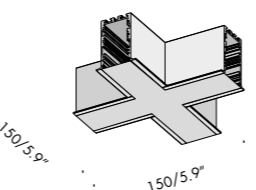
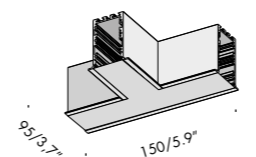
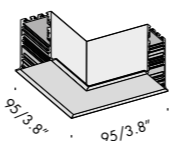
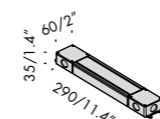
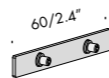

giunti. joints.			
f9.131.01	lineari acciaio inox + grani stainless steel linear + grub screws	2 pz · pcs	0,1kg 0.2lb

accessori. accessories.			
f9.129.96	molle per incasso · recess springs	2 pz · pcs	0,6kg 1.2lb

alimentatori. power supplies.		120-277V	damp	
t4.630.u		24V dimm. 0-10V	96W	0,8kg 1.8lb

raccordi. couplers.		
f9.129.82	raccordo L argento opaco · matt silver L coupler	0,2kg 0.4lb
f9.129.92	raccordo L bianco V · L coupler	0,2kg 0.4lb
f9.129.102	raccordo L nero55 · L coupler	0,2kg 0.4lb
f9.129.83	raccordo T argento opaco · matt silver T coupler	0,2kg 0.4lb
f9.129.93	raccordo T bianco V · T coupler	0,2kg 0.4lb
f9.129.103	raccordo T nero55 · T coupler	0,2kg 0.4lb

f9.129.84	raccordo + argento opaco · matt silver + coupler	0,3kg 0.7lb
f9.129.94	raccordo + bianco V · + coupler	0,3kg 0.7lb
f9.129.104	raccordo + nero55 · + coupler	0,3kg 0.7lb

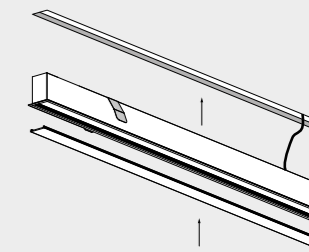
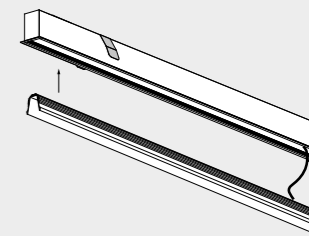
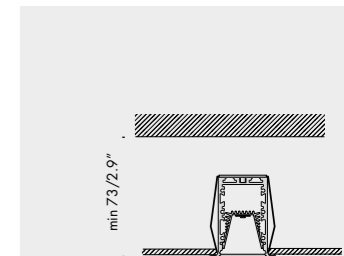

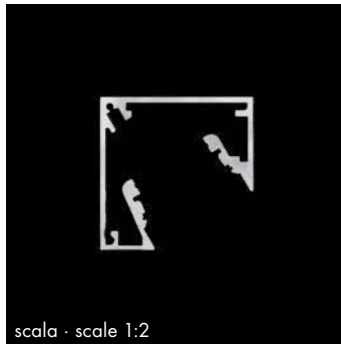

scala · scale 1:2

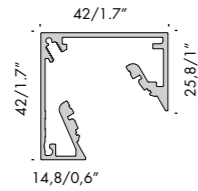

ca 42x42		K	damp	Ⓢ	i
Vb6.194.111	argento opaco · matt silver	3000mm 118.1"	2,3kg 5lb		
Vb6.194.112	bianco V	3000mm 118.1"	2,3kg 5lb		
Vb6.194.115	nero55	3000mm 118.1"	2,3kg 5lb		

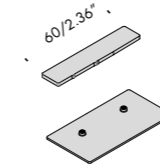

giunti. joints.		i
Vb9.194.17	lineari acciaio inox + grani stainless steel linear + grub screws	2 pz · pcs 0,1kg 0.2lb

-  kit lineare
diffusore satinato
frosted diffuser
-  kit lineare
diffusore prismatico
prismatic diffuser
-  kit lineare
lente ellittica
elliptic lens
-  kit micromen
-  kit vangogh
-  kit trentotto
-  kit ecomini

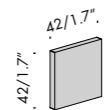

tappi terminali. end caps.		i
Vb9.194.11	argento opaco · matt silver	2 pz · pcs 0,1kg 0.2lb
Vb9.194.12	bianco V	2 pz · pcs 0,1kg 0.2lb
Vb9.194.15	nero55	2 pz · pcs 0,1kg 0.2lb

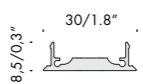

coperchi. covers.		Ⓢ	i
Vb9.194.03	argento opaco · matt silver	3000mm 118.1"	2,3kg 5lb
Vb9.194.04	bianco V	3000mm 118.1"	2,3kg 5lb
Vb9.194.05	nero55	3000mm 118.1"	2,3kg 5lb

ca 42x42
valori lux ricavati considerando le seguenti distanze:
lux values obtained by considering the following distances:

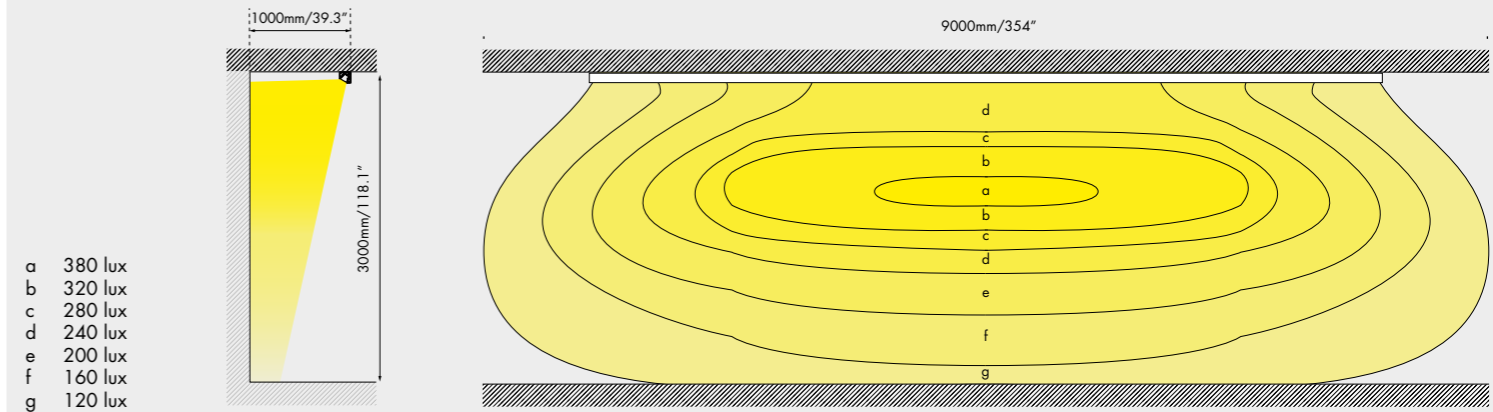

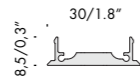
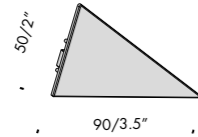
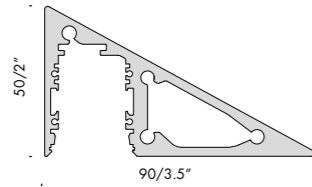
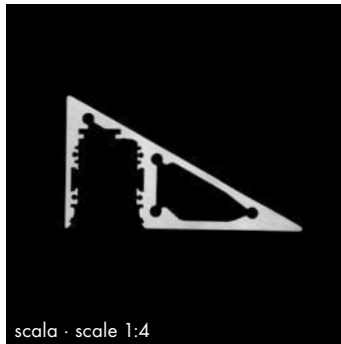

c 16.64		K	damp	Ⓜ	i
Vb6.194.121	argento opaco · matt silver	3000mm 118.1"	2,3kg 5lb		
Vb6.194.122	bianco V	3000mm 118.1"	2,3kg 5lb		
Vb6.194.125	nero55	3000mm 118.1"	2,3kg 5lb		

tappi terminali. end caps.				i
f9.090.94	argento opaco · matt silver	2 pz · pcs	0,1kg 0.2lb	
f9.090.91	bianco V	2 pz · pcs	0,1kg 0.2lb	
f9.090.95	nero55	2 pz · pcs	0,1kg 0.2lb	

coperchi. covers.				Ⓜ	i
Vb9.194.03	argento opaco · matt silver	3000mm 118.1"	2,3kg 5lb		
Vb9.194.04	bianco V	3000mm 118.1"	2,3kg 5lb		
Vb9.194.05	nero55	3000mm 118.1"	2,3kg 5lb		

giunti. joints.				i
f9.090.93	lineari acciaio inox + grani stainless steel linear + grub screws	2 pz · pcs	0,2kg 0.4lb	

installazione a parete
wall mounting

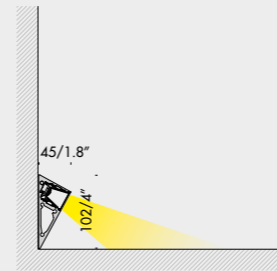

installazione ad incasso
recessed installation

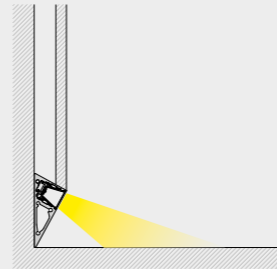

installazione ad incasso
con possibilità di ripresa aria
condizionata
recessed installation with the
possibility of air conditioning intake

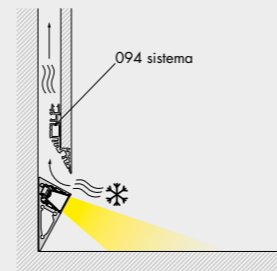

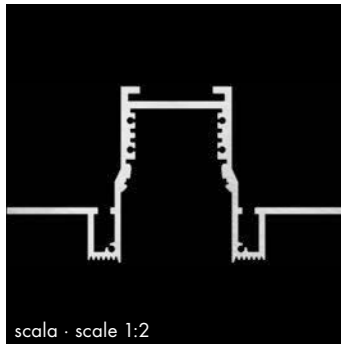

scala · scale 1:2

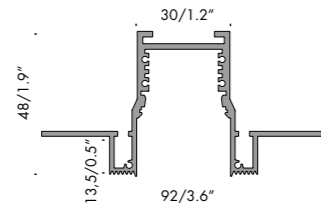

css 92x48		type ic	damp	
Vb6.194.131	argento opaco · matt silver	3000mm 118.1"	2,3kg 5lb	
Vb6.194.132	bianco V	3000mm 118.1"	2,3kg 5lb	
Vb6.194.135	nero55	3000mm 118.1"	2,3kg 5lb	

tappi terminali. end caps.			
Vb9.194.21	argento opaco · matt silver	2 pz · pcs	0,1kg 0.2lb
Vb9.194.22	bianco V	2 pz · pcs	0,1kg 0.2lb
Vb9.194.27	nero55	2 pz · pcs	0,1kg 0.2lb

giunti. joints.		
Vb9.194.25	lineare acciaio inox + grani stainless steel linear + grub screws	0,1kg 0.2lb
Vb9.194.29	angolare acciaio inox + grani stainless steel angle + grub screws	0,1kg 0.2lb



kit lineare
diffusore satinato
frosted diffuser h.5mm

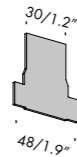

kit lineare
lente ellittica
elliptic lens

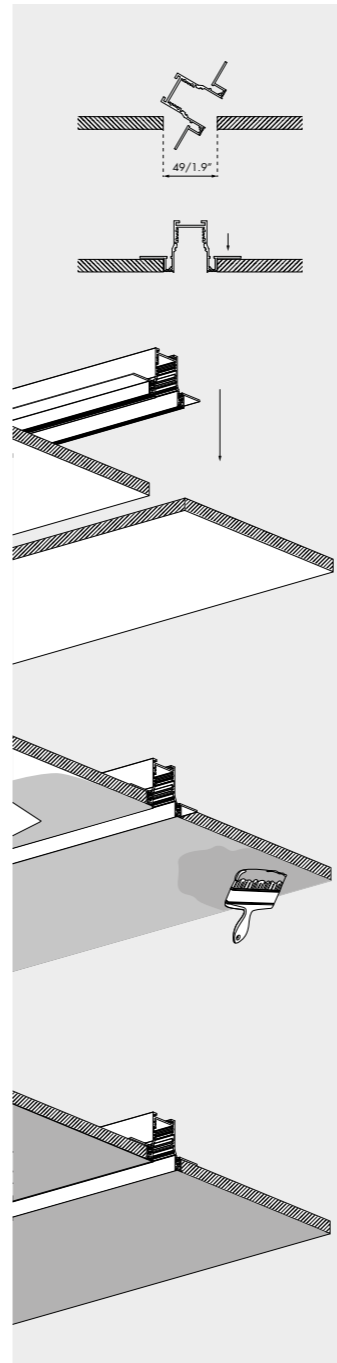
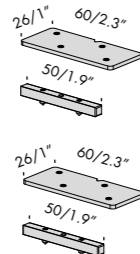

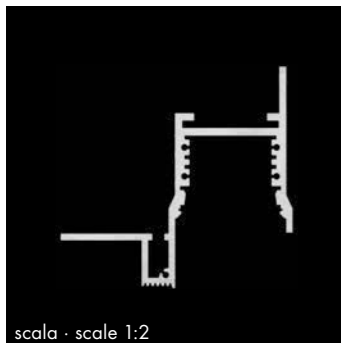

scala · scale 1:2

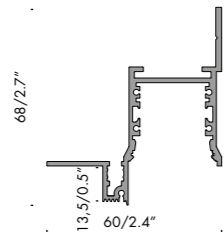



csr 60x68		type ic	damp	
Vb6.194.141	argento opaco · matt silver	3000mm 118.1"		2,3kg 5lb
Vb6.194.142	bianco V	3000mm 118.1"		2,3kg 5lb
Vb6.194.145	nero55	3000mm 118.1"		2,3kg 5lb

tappi terminali. end caps.			
Vb9.194.31	argento opaco · matt silver	2 pz · pcs	0,1kg 0.2lb
Vb9.194.32	bianco V	2 pz · pcs	0,1kg 0.2lb
Vb9.194.35	nero55	2 pz · pcs	0,1kg 0.2lb

giunti. joints.			
Vb9.194.25	lineare acciaio inox + grani stainless steel linear + grub screws		0,1kg 0.2lb
Vb9.194.29	angolare acciaio inox + grani stainless steel angle + grub screws		0,1kg 0.2lb

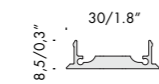
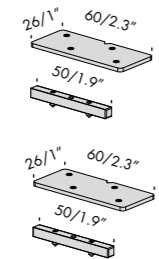
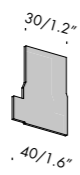
coperchi. covers.			
Vb9.194.03	argento opaco · matt silver	3000mm 118.1"	2,3kg 5lb
Vb9.194.04	bianco V	3000mm 118.1"	2,3kg 5lb
Vb9.194.05	nero55	3000mm 118.1"	2,3kg 5lb



 kit lineare
diffusore satinato
frosted diffuser h.5mm

 kit lineare
lente ellittica
elliptic lens

 kit micromen

 kit vangogh

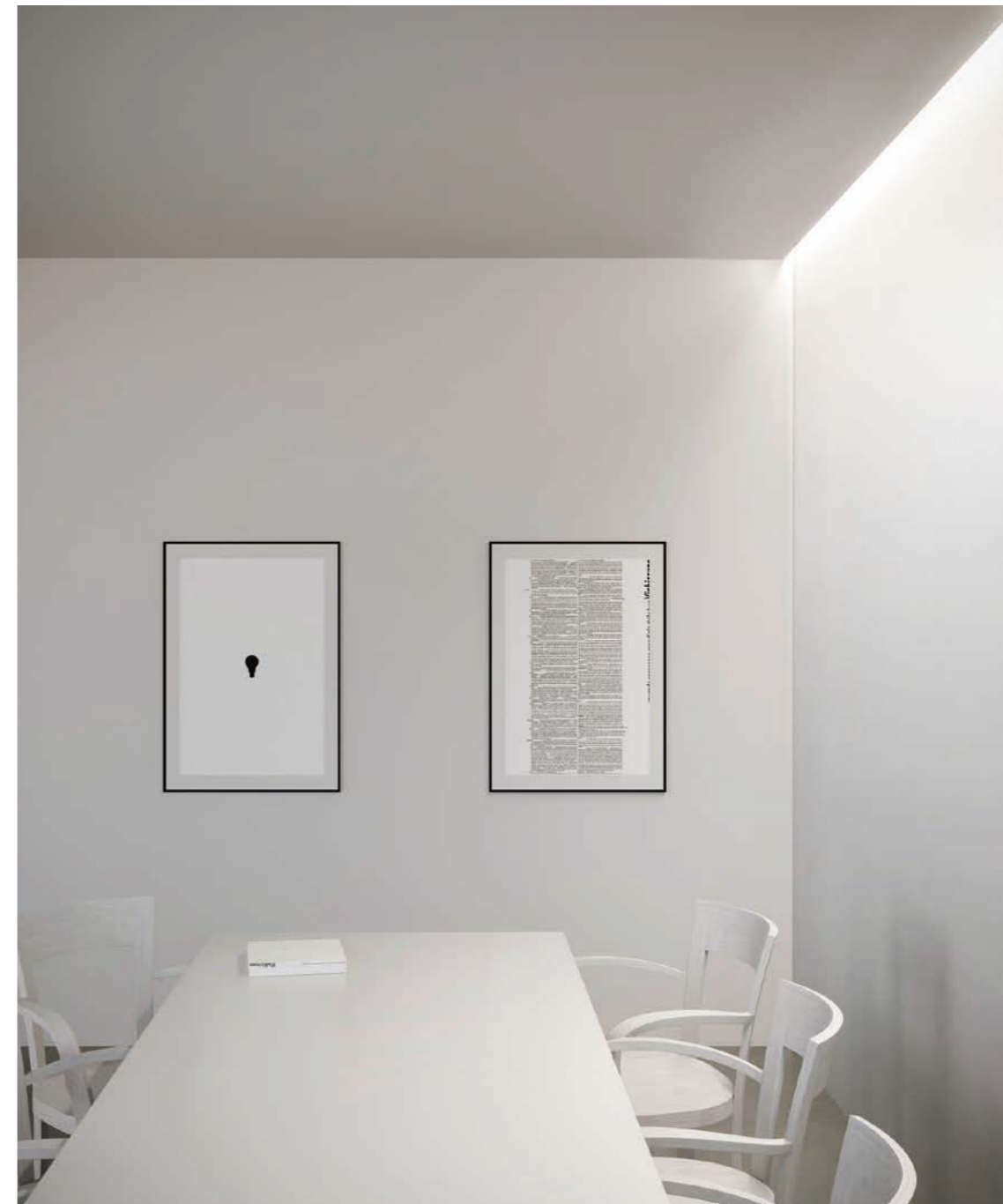
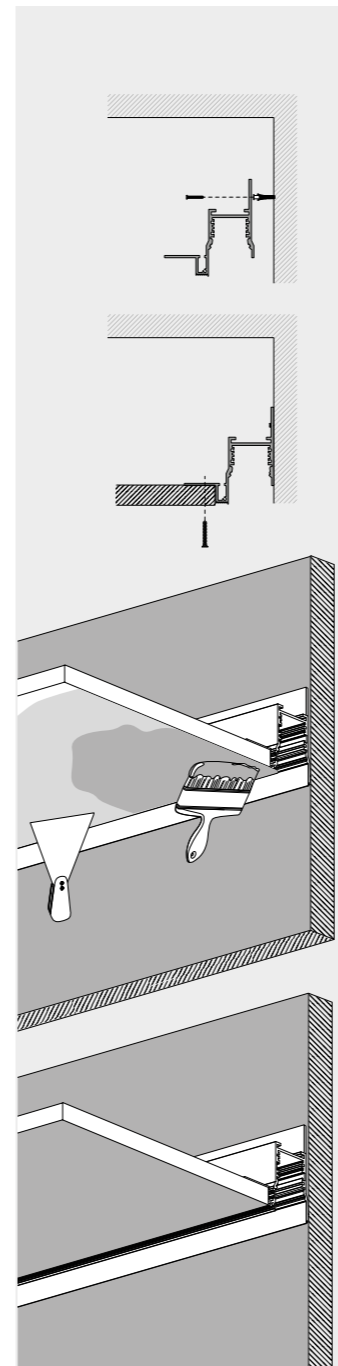

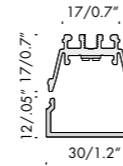
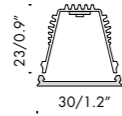
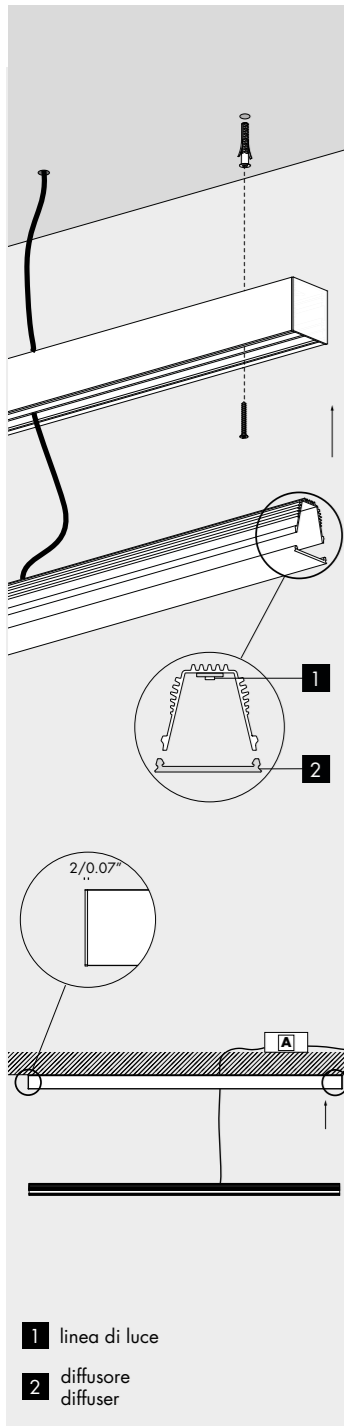

kit lineare satinato frosted		24Vdc	A	K	title24	damp	⚠	Ⓢ	Ⓜ
Vb9.194.152.27	2700K	15,6W	598mm	0,5kg	23.8"	1.1lb			
Vb9.194.153.27	2700K	23,4W	898mm	0,7kg	35.4"	1.5lb			
Vb9.194.154.27	2700K	31,2W	1198mm	1kg	47.1"	2.2lb			
Vb9.194.155.27	2700K	39W	1498mm	1,2kg	59.0"	2.6lb			
Vb9.194.156.27	2700K	78W	2998mm	2,3kg	118.0"	5lb			

Ra	R9	ies tm-30		sdcm	V _f	lm/m	W/m	lm/W
95	90	Rf 90	Rg 98	step 2	24	2400	26	92
V3000	11		Ta25 °C	vita media · average life		50000 h	L80	B10

Vb9.194.152.30	3000K	15,6W	598mm	0,5kg	23.8"	1.1lb			
Vb9.194.153.30	3000K	23,4W	898mm	0,7kg	35.4"	1.5lb			
Vb9.194.154.30	3000K	31,2W	1198mm	1kg	47.1"	2.2lb			
Vb9.194.155.30	3000K	39W	1498mm	1,2kg	59.0"	2.6lb			
Vb9.194.156.30	3000K	78W	2998mm	2,3kg	118.0"	5lb			

Ra	R9	ies tm-30		sdcm	V _f	lm/m	W/m	lm/W
95	90	Rf 93	Rg 102	step 2	24	2500	26	96
V3001	11		Ta25 °C	vita media · average life		50000 h	L80	B10

kit lineare satinato frosted 5mm		24Vdc	A	K	title24	damp	⚠	Ⓢ	Ⓜ
Vb9.194.172.27	kit led css 92x48/csr 60x68	2700K	15,6W	598mm	0,5kg	23.8"	1.1lb		
Vb9.194.173.27	kit led css 92x48/csr 60x68	2700K	23,4W	898mm	0,7kg	35.4"	1.5lb		
Vb9.194.174.27	kit led css 92x48/csr 60x68	2700K	31,2W	1198mm	1kg	47.1"	2.2lb		
Vb9.194.175.27	kit led css 92x48/csr 60x68	2700K	39W	1498mm	1,2kg	59.0"	2.6lb		
Vb9.194.176.27	kit led css 92x48/csr 60x68	2700K	78W	2998mm	2,3kg	118.0"	5lb		

Ra	R9	ies tm-30		sdcm	V _f	lm/m	W/m	lm/W
95	90	Rf 90	Rg 98	step 2	24	2400	26	92
V3000	11		Ta25 °C	vita media · average life		50000 h	L80	B10

Vb9.194.172.30	kit led css 92x48/csr 60x68	3000K	15,6W	598mm	0,5kg	23.8"	1.1lb		
Vb9.194.173.30	kit led css 92x48/csr 60x68	3000K	23,4W	898mm	0,7kg	35.4"	1.5lb		
Vb9.194.174.30	kit led css 92x48/csr 60x68	3000K	31,2W	1198mm	1kg	47.1"	2.2lb		
Vb9.194.175.30	kit led css 92x48/csr 60x68	3000K	39W	1498mm	1,2kg	59.0"	2.6lb		
Vb9.194.176.30	kit led css 92x48/csr 60x68	3000K	78W	2998mm	2,3kg	118.0"	5lb		

Ra	R9	ies tm-30		sdcm	V _f	lm/m	W/m	lm/W
95	90	Rf 93	Rg 102	step 2	24	2500	26	96
V3001	11		Ta25 °C	vita media · average life		50000 h	L80	B10

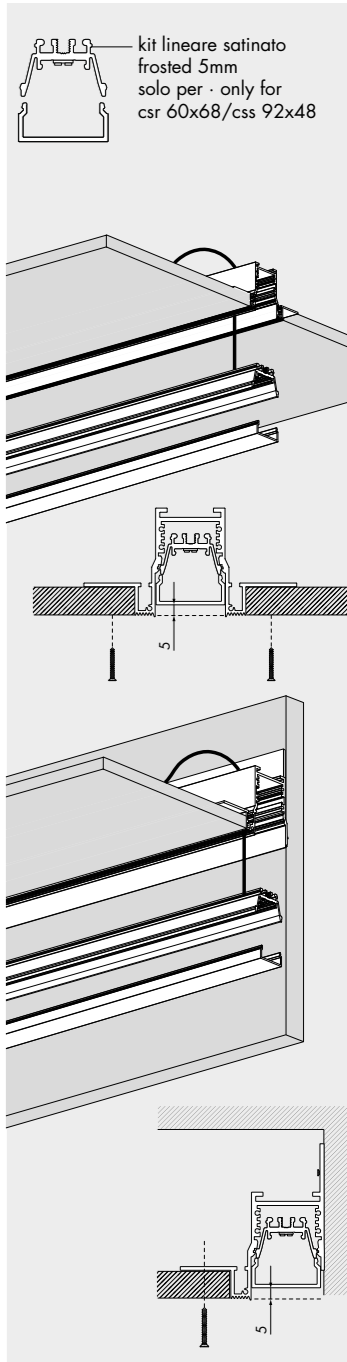

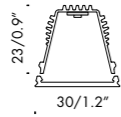

kit lineare prismato prismatic		24Vdc		AI	K	title24	damp	△	Ⓢ	ī
Vb9.194.162.27	2700K					15,6W	598mm	0,5kg		
							23.8"	1.1lb		
Vb9.194.163.27	2700K					23,4W	898mm	0,7kg		
							35.4"	1.5lb		
Vb9.194.164.27	2700K					31,2W	1198mm	1kg		
							47.1"	2.2lb		
Vb9.194.165.27	2700K					39W	1498mm	1,2kg		
							59.0"	2.6lb		
Vb9.194.166.27	2700K					78W	2998mm	2,3kg		
							118.0"	5lb		

Ra	R9	ies tm-30		sdcm	V _f	lm/m	W/m	lm/W
95	90	Rf 90	Rg 98	step 2	24	2400	26	92
V3000	11	Ta25 °C		vita media · average life	50000 h	L80	B10	

Vb9.194.162.30	3000K					15,6W	598mm	0,5kg		
							23.8"	1.1lb		
Vb9.194.163.30	3000K					23,4W	898mm	0,7kg		
							35.4"	1.5lb		
Vb9.194.164.30	3000K					31,2W	1198mm	1kg		
							47.1"	2.2lb		
Vb9.194.165.30	3000K					39W	1498mm	1,2kg		
							59.0"	2.6lb		
Vb9.194.166.30	3000K					78W	2998mm	2,3kg		
							118.0"	5lb		

Ra	R9	ies tm-30		sdcm	V _f	lm/m	W/m	lm/W
95	90	Rf 93	Rg 102	step 2	24	2500	26	96
V3001	11	Ta25 °C		vita media · average life	50000 h	L80	B10	

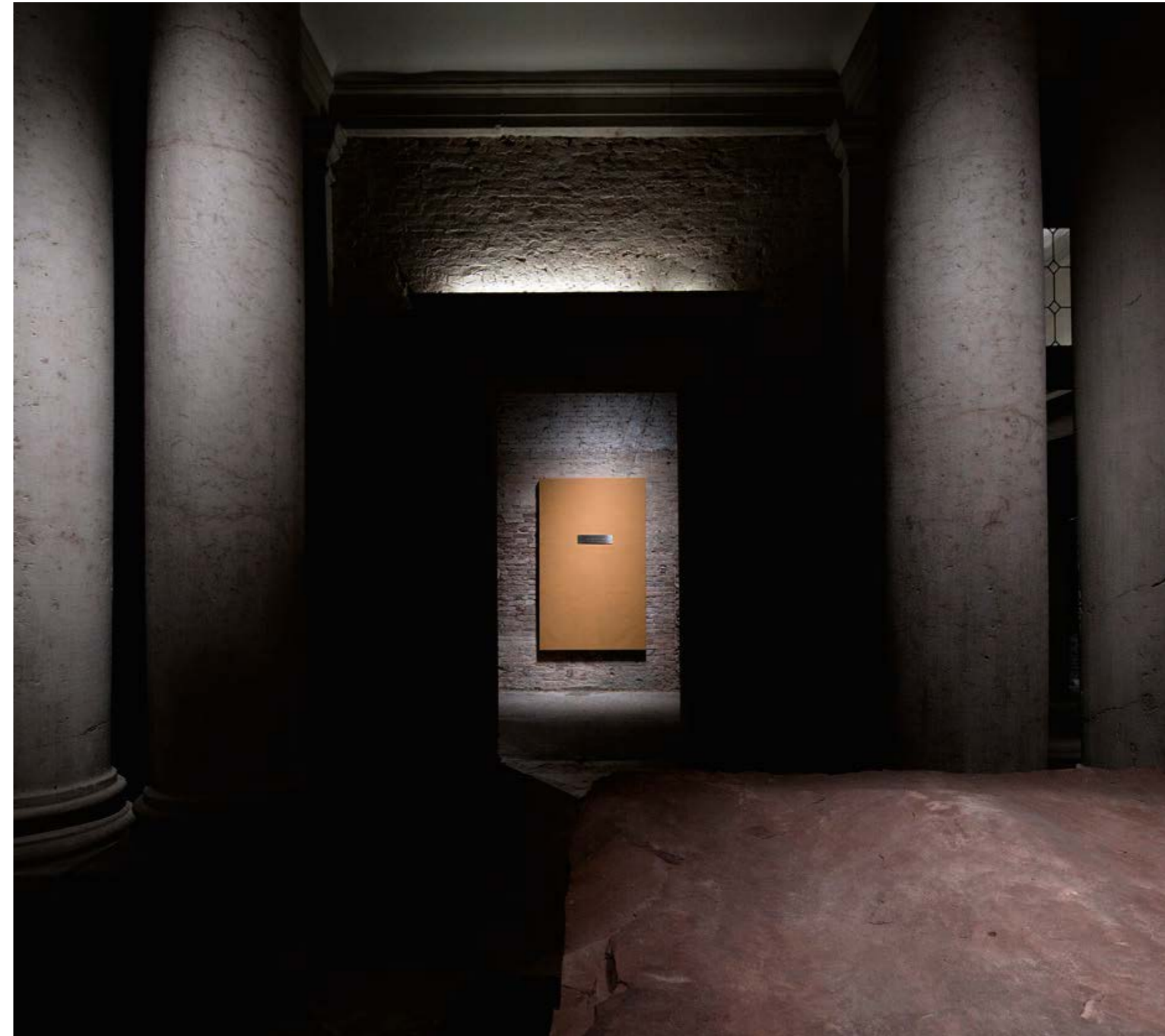

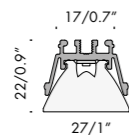

kit lineare ellittica elliptical		24Vdc	AI	K	title24	damp	△	Ⓢ	ⓘ
Vb9.194.182.27	2700K	7,8W	41°x84°	598mm	0,5kg	23.8"	1.1lb		
Vb9.194.183.27	2700K	11,7W	41°x84°	898mm	0,7kg	35.4"	1.5lb		
Vb9.194.184.27	2700K	15,6W	41°x84°	1198mm	1kg	47.1"	2.2lb		
Vb9.194.185.27	2700K	19,5W	41°x84°	1498mm	1,2kg	59.0"	2.6lb		
Vb9.194.186.27	2700K	39W	41°x84°	2998mm	2,3kg	118.0"	5lb		

Ra	R9	ies tm/30		sdcm	Vf	lm/m	W/m	lm/W
95	90	Rf 93	Rg 102	step 2	24	1200	13	92
V0000		5,9	ⓈⓈⓈⓈ	Ta25 °C	vita media · average life		50000 h	L80 B10

Vb9.194.182.30	3000K	7,8W	41°x84°	598mm	0,5kg	23.8"	1.1lb		
Vb9.194.183.30	3000K	11,7W	41°x84°	898mm	0,7kg	35.4"	1.5lb		
Vb9.194.184.30	3000K	15,6W	41°x84°	1198mm	1kg	47.1"	2.2lb		
Vb9.194.185.30	3000K	19,5W	41°x84°	1498mm	1,2kg	59.0"	2.6lb		
Vb9.194.186.30	3000K	39W	41°x84°	2998mm	2,3kg	118.0"	5lb		

Ra	R9	ies tm/30		sdcm	Vf	lm/m	W/m	lm/W
95	90	Rf 93	Rg 102	step 2	24	1250	13	96
V0001		5,9	ⓈⓈⓈⓈ	Ta25 °C	vita media · average life		50000 h	L80 B10

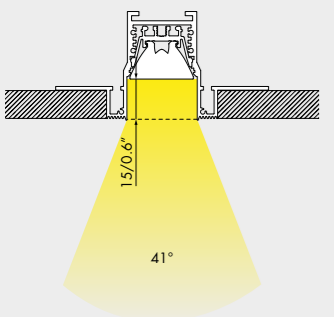
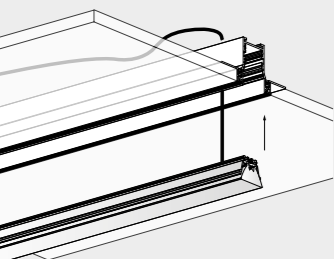

kit micromen 13°

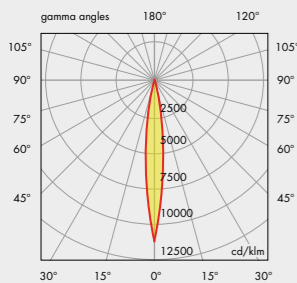

125/4.9° 30/1.2°



kit micromen 13° c sistema		24Vdc	K	damp	⚠	Ⓢ	i
Vb9.194.195.27	argento opaco · matt silver	2700K	13°-13°	0,1kg 0.2lb			
Vb9.194.196.27	bianco V	2700K	13°-13°	0,1kg 0.2lb			
Vb9.194.197.27	nero55	2700K	12°-12°	0,1kg 0.2lb			

Ra	ies tm-30		sdcm	mA	V _{f (min)}	lm	W	lm/W
90	Rf 90	Rg 100	step 2	300	5,6	170	2,0	85
ca010-2	les2	Ta25 °C	vita media · average life		50000 h	L80	B10	

Vb9.194.194.30	argento opaco · matt silver	3000K	13°-13°	0,1kg 0.2lb			
Vb9.194.195.30	bianco V	3000K	13°-13°	0,1kg 0.2lb			
Vb9.194.196.30	nero55	3000K	12°-12°	0,1kg 0.2lb			

Ra	ies tm-30		sdcm	mA	V _{f (min)}	lm	W	lm/W
90	Rf 90	Rg 100	step 2	300	5,6	180	2,0	90
ca011-2	les2	Ta25 °C	vita media · average life		50000 h	L80	B10	

125/4.9° 30/1.2°



kit micromen 25° c sistema		24Vdc	K	damp	⚠	Ⓢ	i
Vb9.194.198.27	argento opaco · matt silver	2700K	25°-25°	0,1kg 0.2lb			
Vb9.194.199.27	bianco V	2700K	25°-25°	0,1kg 0.2lb			
Vb9.194.200.27	nero55	2700K	23°-23°	0,1kg 0.2lb			

Ra	ies tm-30		sdcm	mA	V _{f (min)}	lm	W	lm/W
90	Rf 90	Rg 100	step 2	300	5,6	170	2,0	85
ca010-2	les2	Ta25 °C	vita media · average life		50000 h	L80	B10	

Vb9.194.198.30	argento opaco · matt silver	3000K	25°-25°	0,1kg 0.2lb			
Vb9.194.199.30	bianco V	3000K	25°-25°	0,1kg 0.2lb			
Vb9.194.200.30	nero55	3000K	23°-23°	0,1kg 0.2lb			

Ra	ies tm-30		sdcm	mA	V _{f (min)}	lm	W	lm/W
90	Rf 90	Rg 100	step 2	300	5,6	180	2,0	90
ca011-2	les2	Ta25 °C	vita media · average life		50000 h	L80	B10	

kit micromen 25°

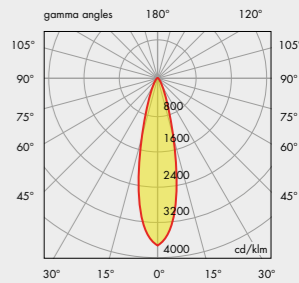

kit vangogh 21°

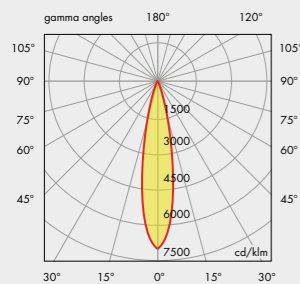

42/1.6° 125/4.9° 30/1.2°



kit vangogh c sistema		24Vdc			damp			
Vb9.194.191.27	argento opaco · matt silver	2700K	21°-21°	0,1kg 0.2lb				
Vb9.194.192.27	bianco V	2700K	21°-21°	0,1kg 0.2lb				
Vb9.194.193.27	nero55	2700K	21°-21°	0,1kg 0.2lb				

Ra	ies tm-30		sdc	mA	V _f (min)	lm	W	lm/W
95	Rf 92	Rg 100	step 2	250	17,6	376	4,4	86
cd020-2	les6	Ta25 °C	vita media · average life		50000 h	L80	B10	

Vb9.194.191.30	argento opaco · matt silver	3000K	21°-21°	0,1kg 0.2lb				
Vb9.194.192.30	bianco V	3000K	21°-21°	0,1kg 0.2lb				
Vb9.194.193.30	nero55	3000K	21°-21°	0,1kg 0.2lb				

Ra	ies tm-30		sdc	mA	V _f (min)	lm	W	lm/W
95	Rf 92	Rg 100	step 2	250	17,6	428	4,4	97
cd021-2	les6	Ta25 °C	vita media · average life		50000 h	L80	B10	

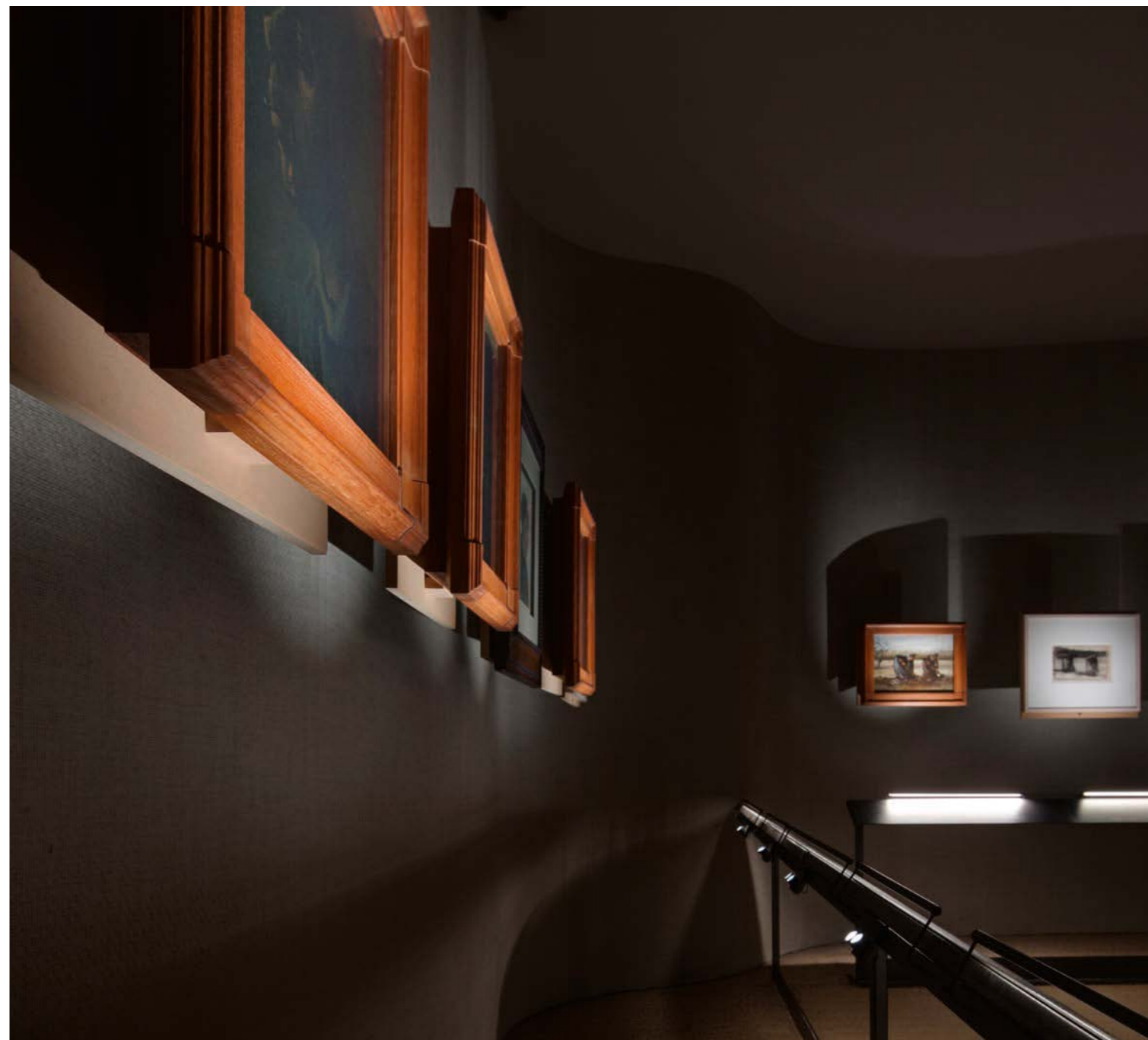

kit trentotto 19°

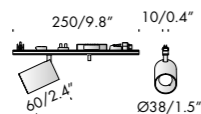
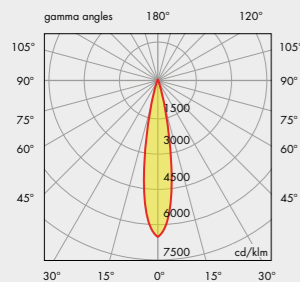

kit trentotto 19° c sistema	24Vdc			damp			
------------------------------------	--------------	--	--	-------------	--	--	--

- Vb9.194.227.27** argento opaco · matt silver 2700K 19° 0,2kg 0.4lb
- Vb9.194.228.27** bianco V 2700K 19° 0,2kg 0.4lb
- Vb9.194.226.27** nero55 2700K 19° 0,2kg 0.4lb

Ra	R9	ies tm-30		sdc	mA	V _f (min)	lm	W	lm/W
98	95	Rf 95	Rg 100	step 2	350	16,0	544	5,6	97
cd040	lesó	Ta25 °C		vita media · average life		50000 h	L70	B10	

- Vb9.194.227.30** argento opaco · matt silver 3000K 19° 0,2kg 0.4lb
- Vb9.194.228.30** bianco V 3000K 19° 0,2kg 0.4lb
- Vb9.194.226.30** nero55 3000K 19° 0,2kg 0.4lb

Ra	ies tm-30		sdc	mA	V _f (min)	lm	W	lm/W
95	Rf 92	Rg 100	step 2	350	17	455	6	76
cd011	lesó	Ta25 °C		vita media · average life		50000 h	L70	B10

kit trentotto 41° c sistema

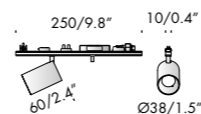

kit trentotto 41° c sistema	24Vdc			damp			
------------------------------------	--------------	--	--	-------------	--	--	--

- Vb9.194.230.27** argento opaco · matt silver 2700K 41° 0,2kg 0.4lb
- Vb9.194.231.27** bianco V 2700K 41° 0,2kg 0.4lb
- Vb9.194.229.27** nero55 2700K 41° 0,2kg 0.4lb

Ra	R9	ies tm-30		sdc	mA	V _f (min)	lm	W	lm/W
98	95	Rf 95	Rg 100	step 2	350	16,0	544	5,6	97
cd040	lesó	Ta25 °C		vita media · average life		50000 h	L70	B10	

- Vb9.194.230.30** argento opaco · matt silver 3000K 41° 0,2kg 0.4lb
- Vb9.194.231.30** bianco V 3000K 41° 0,2kg 0.4lb
- Vb9.194.229.30** nero55 3000K 41° 0,2kg 0.4lb

Ra	ies tm-30		sdc	mA	V _f (min)	lm	W	lm/W
95	Rf 92	Rg 100	step 2	350	17	455	6	76
cd011	lesó	Ta25 °C		vita media · average life		50000 h	L70	B10

kit trentotto 41°

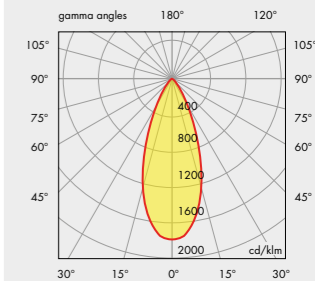

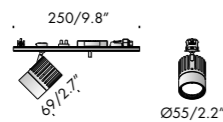
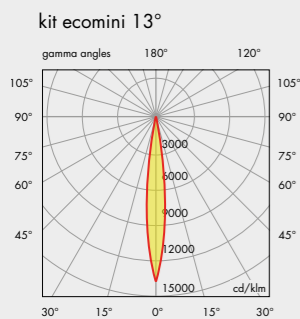

kit ecomini 13° c sistema		24Vdc	K	damp	⚠	Ⓢ	ⓘ
Vb9.194.201.27	argento opaco · matt silver	2700K	13°	0,4kg	0,9lb		
Vb9.194.202.27	bianco V	2700K	13°	0,4kg	0,9lb		
Vb9.194.203.27	nero55	2700K	13°	0,4kg	0,9lb		

Ra	R9	ies tm-30		sdc	mA	V _f (min)	lm	W	lm/W
98	95	Rf 95	Rg 100	step 2	700	16,5	1026	11,6	89
cd040	les6	Ta25 °C		vita media · average life		50000 h	L70	B10	

Vb9.194.201.30	argento opaco · matt silver	3000K	13°	0,4kg	0,9lb		
Vb9.194.202.30	bianco V	3000K	13°	0,4kg	0,9lb		
Vb9.194.203.30	nero55	3000K	13°	0,4kg	0,9lb		

Ra	ies tm-30		sdc	mA	V _f (min)	lm	W	lm/W
95	Rf 92	Rg 100	step 2	700	17,8	826	12,4	66
cd011	les6	Ta25 °C		vita media · average life		50000 h	L70	B10

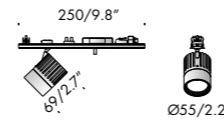

kit ecomini 19° c sistema		24Vdc	K	damp	⚠	Ⓢ	ⓘ
Vb9.194.205.27	argento opaco · matt silver	2700K	19°	0,4kg	0,9lb		
Vb9.194.206.27	bianco V	2700K	19°	0,4kg	0,9lb		
Vb9.194.207.27	nero55	2700K	19°	0,4kg	0,9lb		

Ra	ies tm-30		sdc	mA	V _f (min)	lm	W	lm/W
95	Rf 92	Rg 100	step 2	700	18,2	1000	12,7	79
ce000	les9	Ta25 °C		vita media · average life		50000 h	L70	B10

Vb9.194.205.30	argento opaco · matt silver	3000K	19°	0,4kg	0,9lb		
Vb9.194.206.30	bianco V	3000K	19°	0,4kg	0,9lb		
Vb9.194.207.30	nero55	3000K	19°	0,4kg	0,9lb		

Ra	ies tm-30		sdc	mA	V _f (min)	lm	W	lm/W
95	Rf 92	Rg 100	step 2	700	18,2	1075	12,7	85
ce001	les9	Ta25 °C		vita media · average life		50000 h	L70	B10

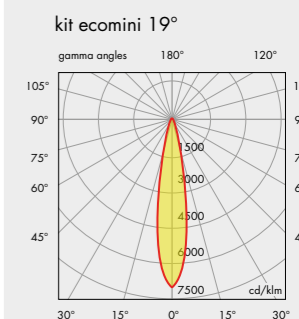

kit ecomini 36°

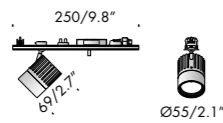
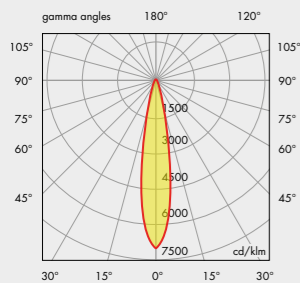

kit ecomini 36° c sistema		24Vdc	A	K	damp	⚠	Ⓢ	i
Vb9.194.208.27	argento opaco · matt silver	2700K	36°	0,4kg	0,9lb			
Vb9.194.209.27	bianco V	2700K	36°	0,4kg	0,9lb			
Vb9.194.210.27	nero55	2700K	36°	0,4kg	0,9lb			

Ra	ies tm-30	sdc	mA	V _{f (min)}	lm	W	lm/W
95	Rf 92 Rg 100	step 2	700	18,2	1000	12,7	79
ce000	les9 ● Ta25 °C	vita media · average life		50000 h	L70	B10	

Vb9.194.208.30	argento opaco · matt silver	3000K	36°	0,4kg	0,9lb			
Vb9.194.209.30	bianco V	3000K	36°	0,4kg	0,9lb			
Vb9.194.210.30	nero55	3000K	36°	0,4kg	0,9lb			

Ra	ies tm-30	sdc	mA	V _{f (min)}	lm	W	lm/W
95	Rf 92 Rg 100	step 2	700	18,2	1075	12,7	85
ce001	les9 ● Ta25 °C	vita media · average life		50000 h	L70	B10	



lettura delle tabelle tecniche how to read technical tables

xxxxxxxxxxxxxxxx							120V 50-60Hz	A	wet	UL	UL US	i
a	b	c	d	e	f	f	g					

xxxxxxxxxxxxxxxx							120V 50-60Hz	A	wet	UL	UL US	i
Vbx.xxx.xx	nero55	3000K	35W	20°	0,8kg	1.8lb						
h	i	l	m	n	g							

componenti. components.

accessori. accessories.

1	2	3	4	5	6	7	8	9	
Ra	R9	ies tm-30		sdc	mA	V _{f (min)}	lm	W	lm/W
98	98	Rf 96	Rg 103	step 1	350	27,6	1240	9,7	128
					500	27,9	1580	14,0	113
xm000	les19	Ta25 °C		vita media · average life		50000 h	L80	B10	
10	11						12	13	

classificazione ambiente di installazione installation location rating

bandella tecnica. posizioni standard simbologie.
data plate. standard arrangement of symbols.

a	nome apparecchio di illuminazione · light fitting name
b	tensione di alimentazione · supply rating (Volt)
c	frequenza di alimentazione · supply frequency (Hertz)
d	alimentatore incluso o escluso · power supply included or not included
e	classificazione ambiente di installazione · installation location rating
f	marchio di certificazione · safety and quality standards certification
g	peso netto · net weight (kg/lb)
h	codice · code
i	finiture · colours and finishes
l	temperatura colore sorgente elettronica colour temperature led source (Kelvin)
m	potenza della sorgente · source power (Watt)
n	gradi fascio luminoso · light beam degrees

componenti. identifica tutti gli elementi indispensabili per la corretta funzionalità e installazione dell'apparecchio di illuminazione.
components. includes all items that are essential to the correct operation and installation of the light fitting.

accessori. si riferisce alle ulteriori parti installabili sull'apparecchio.
accessories. refers to items that can be added to the light fitting.

1	indice di resa cromatica · colour rendering index
2	indice di resa del rosso · red colour rendering index
3	Rf indice di fedeltà colore · colour fidelity index Rg indice di saturazione colore · color gamut index
4	step di macadam · macadam step
5	corrente di alimentazione · power supply current
6	tensione di alimentazione · power supply voltage
7	flusso luminoso · light flux
8	potenza della sorgente · source power
9	efficienza della sorgente · source efficiency
10	codice sorgente elettronica Viabizzuno · Viabizzuno led source code
11	superficie emittente · light emitting surface (mm)
12	% flusso residuo a fine vita · end life % flux
13	% consentita sotto limite · allowed % under limit

wet prodotto classificato per uso esterno · product classified for outdoor use

damp prodotto classificato per uso interno in ambienti umidi (bagno, sauna, ecc..) · product classified for indoor use in damp environments (bathrooms, saunas, etc.)

dry prodotto classificato per uso interno in ambienti asciutti · product classified for indoor use in dry environments

legenda simboli symbols legenda

 prodotto in conformità con le direttive nord americane sui soffioni doccia · produced in compliance with showerheads northamerican directives

 componente certificato per il mercato nord americano idoneo ad essere utilizzato e valutato come parte di in un sistema più complesso
component approved for north american market and suitable to be used and approved as part of a more complex system

 prodotto finito idoneo per essere commercializzato nel mercato nord americano · listed product suitable for the north american market

 prodotto finito idoneo per essere commercializzato nel mercato nord americano · listed product suitable for the north american market

type ic apparecchio di illuminazione ad incasso progettato per funzionare a contatto con materiale isolante.
recessed luminaire designed to work in contact with thermal insulation.

type non-ic apparecchio di illuminazione ad incasso progettato per funzionare in intercapedini che abbiano una certa distanza da materiali isolanti.
recessed luminaire designed to work in cavities that have a minimum dimensions and spacings to thermal insulation.

title24 prodotto conforme allo standard title24 · product compliant with title24 standard

 vetro opalino · opal glass

 vetro sabbiato · sanded glass

 vetro nero fumè · black smoke glass

 vetro trasparente · transparent glass

 vetro bianco latte · white milk glass

 cristallo · crystal

 policarbonato opalino · opal polycarbonate diffuser

 carrabile · drive over

A alimentatore incluso · power supply included

A alimentatore escluso · power supply not included

AR alimentatore remoto incluso · remote power supply included

Ai alimentatore elettronico con controllo intelligente incluso · electronic power supply with smart control included

AiR alimentatore elettronico con controllo intelligente incluso, da installare remoto · electronic power supply with smart control included, to be installed remotely

AS alimentatore a spina incluso · plug power supply included

T trasformatore incluso · transformer included

K kit di cablaggio incluso · wiring kit not included

K kit di cablaggio escluso · wiring kit not included

L lampadina con sorgente elettronica led, ad incandescenza, alogena o fluorescente inclusa.
bulb with led electronic source, incandescent, halogen or fluorescent included.

L lampadina con sorgente elettronica led, ad incandescenza, alogena o fluorescente esclusa.
bulb with led electronic source, incandescent, halogen or fluorescent not included.

PR propulsore dinamico n55 incluso · included

 attenzione: sorgente luminosa led. non guardare mai direttamente a occhio nudo · attention: led light source. never look straight without eye protection

i peso netto · net weight (kg)

 possibilità di combinazione tra interfaccia n55, propulsore dinamico n55 e lampadina n55 · possible combination between n55 interface, propulsore dinamico n55 and n55 bulb

I.d. luce diretta · direct light

I.i. luce indiretta · indirect light

V  disponibile su · available on *Viabizzuno applight* www.Viabizzuno.com *Viabizzuno online*