



Viabizzuno strada principale della frazione di bizzuno in provincia di ravenna dove tra la casa del popolo e la parrocchia, al n°17, sono nato il ventuno luglio millenovecentocinquantacinque. da qui nasce il nome della fabbrica di produzione fondata nel millenovecentonovantaquattro rappresentata da uno spazio bianco attraversato da due linee. una verticale, rigorosa, essenziale, equilibrata: la luce per la luce; ed una inclinata, irriverente nello spazio, ironica, fuori dagli schemi: la luce per la forma. distinte ma complementari si fondono in un unico nome: Viabizzuno.

marionanni

Viabizzuno is the name of the main road of the small village bizzuno located in the province of ravenna, where I was born on the twenty-first july nineteenfiftyfive at n°17, between the 'casa del popolo' and the local parish church. from here the name of the factory founded in nineteen ninety-four represented by a white space intersected by two lines. one vertical, well balanced, logical, essential: the light for the light. the other one dynamic, irreverent, ironic: the light for the form. separate and yet complementary they cast in the same name: Viabizzuno.

prodotto
product



schede tecniche
technical data sheets



curve fotometriche
photometric curves



modelli 3d per i tuoi render
3d models for your render



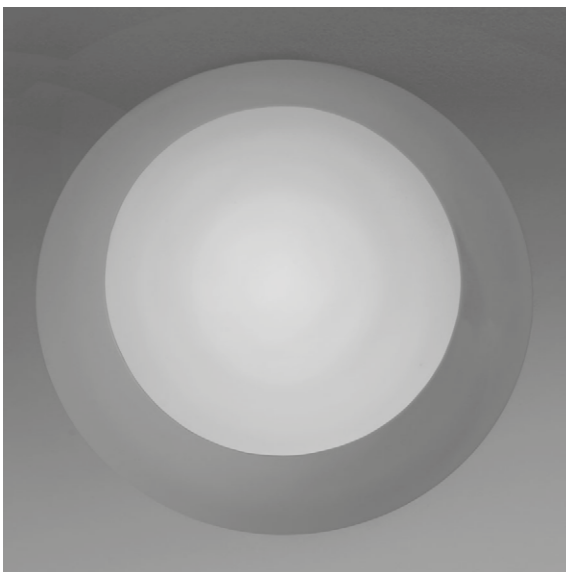
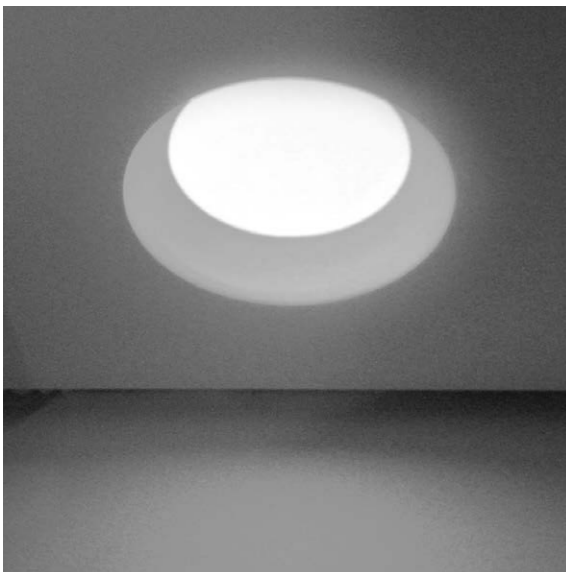

apparecchio di illuminazione da incasso a soffitto per interni. realizzato in gesso verniciato per integrarsi totalmente nell'architettura. è possibile installare al suo interno vari kit luminosi per creare differenti scenografie.

modelli:

campana brembana 900 a scomparsa totale di dimensioni 1200x1200x900mm/47.2x47.2x35.4" con foro diametro Ø800mm/31.5", campana brembana ribassata 350 di dimensioni 1200x1200x350mm/47.2x47.2x13.7" con foro diametro Ø750mm/29.5" sporgente di 142mm/5.5" da soffitto,

campana brembana 400 a scomparsa totale di dimensioni 595x595x400mm/23.4x23.4x15.7" con foro diametro Ø405mm/15.9",

campana brembana ribassata 250 di dimensioni 595x595x250mm/23.4x23.4x9.8" con foro diametro Ø365mm/14.3" sporgente di 37mm/1.4" da soffitto.

disponibili kit sorgente elettronica 2700K, 3000K e 4000K Ra95 6W e 12,2W. alimentatore 120-277V escluso, da installare remoto.

possibilità di dimmerazione 1-10V.

finiture: gesso verniciato bianco.

damp location rated recessed ceiling light fitting for indoor use. made of painted plaster to totally integrate within the architecture. several lighting kits available to be installed in the light fitting to create different scenographies.

versions:

campana brembana 900 fully concealed sizes 1200x1200x900mm/47.2x47.2x35.4" with diameter Ø800mm/31.5" hole,

campana brembana ribassata 350 sizes 1200x1200x350mm/47.2x47.2x13.7" with diameter Ø750mm/29.5" hole protruding by 142mm/5.5" from the ceiling,

campana brembana 400 sizes 595x595x400mm/23.4x23.4x15.7" with diameter Ø405mm/15.9" hole,



campana brembana ribassata 250 sizes 595x595x250mm/23.4x23.4x9.8" with diameter Ø365mm/14.3" hole protruding by 37mm/1.4" from the ceiling.

2700K 3000K and 4000K Ra95 6W and 12.2W led kit. 120-277V power supply not included, to be installed remotely.

possible 1-10V dimming.

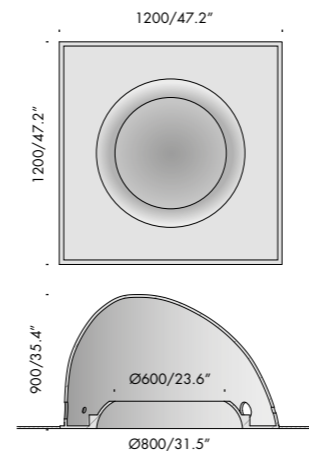
finishes: white painted plaster.



campana brembana 900  **damp**  

f6.205.01 corpo in gesso con foro incassato plaster body with recessed hole 900mm 35.4" 85kg 189.6lb

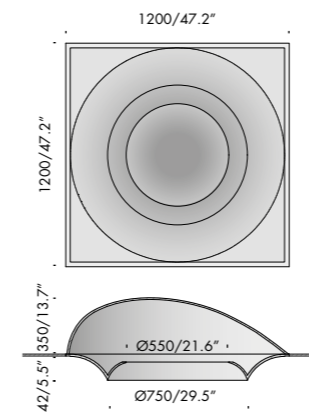

campana brembana ribassata 350  **damp**  

f6.205.03 corpo in gesso con foro semi incassato plaster body with semi-recessed hole 350mm 13.8" 70kg 154.3lb

max 4 kit led bianchi
max 4 white kit led

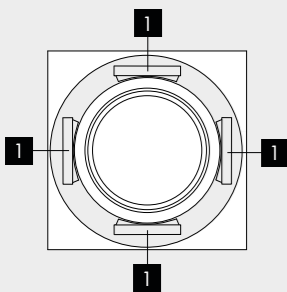
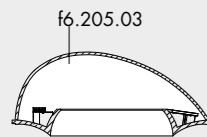
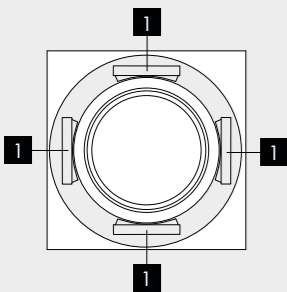
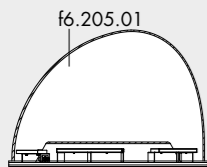
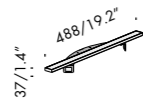

1 Vb6.205.31.27/30/40

kit campana 900/350 24Vdc **damp**

Vb6.205.31.27 2700K 12,2W 0,2kg
0.4lb

Ra	R9	ies tm-30		sdcm	V _f	lm/m	W/m	lm/W
95	90	Rf 90	Rg 98	step 2	24	2400	26	92
V3000	11		Ta25 °C		vita media · average life 50000 h		L80 B10	

Vb6.205.31.30 3000K 12,2W 0,2kg
0.4lb

Ra	R9	ies tm-30		sdcm	V _f	lm/m	W/m	lm/W
95	90	Rf 93	Rg 102	step 2	24	2500	26	96
V3001	11		Ta25 °C		vita media · average life 50000 h		L80 B10	

Vb6.205.31.40 4000K 12,2W 0,2kg
0.4lb

Ra	R9	ies tm/30		sdcm	V _f	lm/m	W/m	lm/W
95	95	Rf 90	Rg 98	step 2	24	2600	26	100
V3003	11		Ta25 °C		vita media · average life 50000 h		L80 B10	



max 3 kit led bianchi
max white kit led

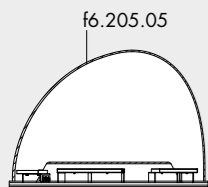

f6.205.05

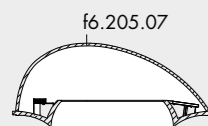
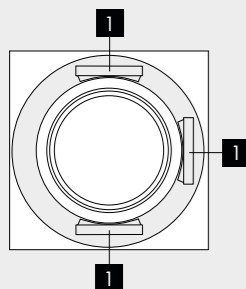

f6.205.07

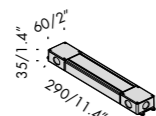
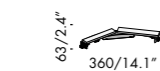
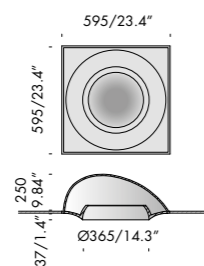
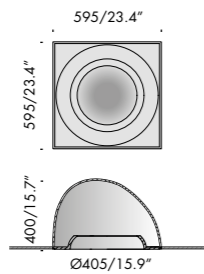
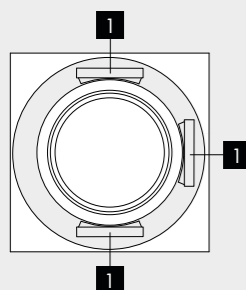

1 Vb6.205.53

campana brembana 400



damp



f6.205.05 corpo in gesso con foro incassato
plaster body with recessed hole 400mm 42,5kg
93.7lb

campana brembana ribassata 250



damp



f6.205.07 corpo in gesso con foro semi incassato
plaster body with semi-recessed hole 250mm 35kg
77.1lb

kit campana brembana 400/250 24Vdc



damp



Vb6.205.53 3000K 2x3W 0,2kg
0.4lb

Ra	R9	ies tm/30	sdc	Vf	lm/m	W/m	lm/W
95	90	Rf 93 Rg 102	step 2	24	1250	13	96
V0001		5,9	Ta25 °C	vita media · average life	50000 h	L80	B10

alimentatori. power supplies.

120-277V



damp



t4.630.u 24V dimm. 1-10V 96W 0,8kg
1.8lb



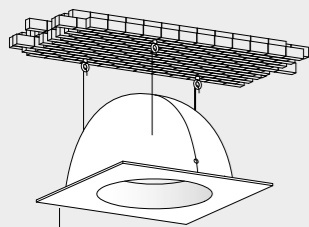

f6.205.01 / f6.205.05

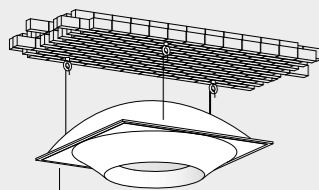
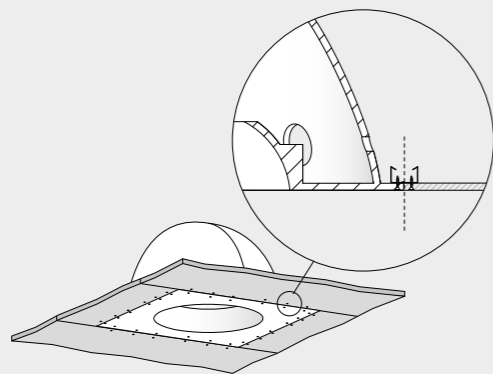

f6.205.03 / f6.205.07

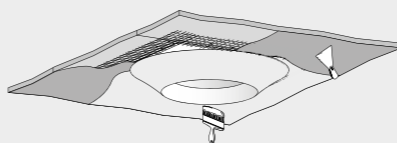
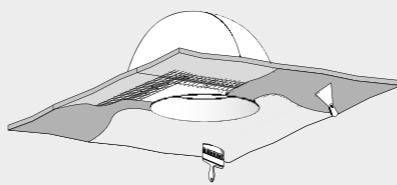
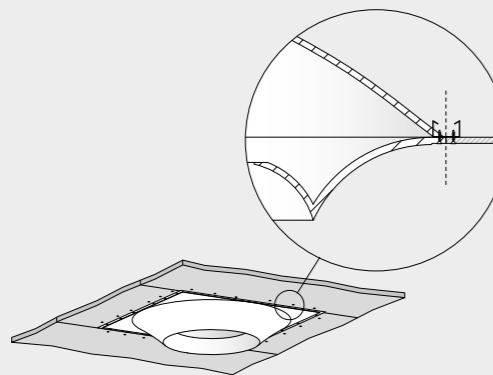

fissare a soffitto appositi occhielli e sospendere il corpo in gesso.
fasten the special eyelets to the ceiling and hang the plaster body.

fissare al corpo in gesso le lastre in cartongesso in modo da completare la realizzazione del controsoffitto.
fasten the plasterboard plates to the plaster body in such a way to complete the false ceiling.

posizionare quattro strisce di apposita garza sulla giunzione tra il corpo e il cartongesso.
stuccare, rasare e verniciare.
attenzione: rasare solo fino al bordo.
place four strips of special gauze on the connection between body and plasterboard.
attention: shim up to the edge only.



lettura delle tabelle tecniche how to read technical tables

xxxxxxxxxxxxxxxx							120V 50-60Hz	A	wet	UL	UL US	i
a	b	c	d	e	f	f	g					

xxxxxxxxxxxxxxxx							120V 50-60Hz	A	wet	UL	UL US	i
Vbx.xxx.xx	nero55	3000K	35W	20°	0,8kg	1.8lb						
h	i	l	m	n	g							

componenti. components.

accessori. accessories.

1	2	3	4	5	6	7	8	9	
Ra	R9	ies tm-30		sdc	mA	V _{f (min)}	lm	W	lm/W
98	98	Rf 96	Rg 103	step 1	350	27,6	1240	9,7	128
					500	27,9	1580	14,0	113
xm000	les19	Ta25 °C		vita media · average life		50000 h	L80	B10	
10	11						12	13	

classificazione ambiente di installazione installation location rating

bandella tecnica. posizioni standard simbologie.
data plate. standard arrangement of symbols.

a	nome apparecchio di illuminazione · light fitting name
b	tensione di alimentazione · supply rating (Volt)
c	frequenza di alimentazione · supply frequency (Hertz)
d	alimentatore incluso o escluso · power supply included or not included
e	classificazione ambiente di installazione · installation location rating
f	marchio di certificazione · safety and quality standards certification
g	peso netto · net weight (kg/lb)
h	codice · code
i	finiture · colours and finishes
l	temperatura colore sorgente elettronica colour temperature led source (Kelvin)
m	potenza della sorgente · source power (Watt)
n	gradi fascio luminoso · light beam degrees

componenti. identifica tutti gli elementi indispensabili per la corretta funzionalità e installazione dell'apparecchio di illuminazione.
components. includes all items that are essential to the correct operation and installation of the light fitting.

accessori. si riferisce alle ulteriori parti installabili sull'apparecchio.
accessories. refers to items that can be added to the light fitting.

1	indice di resa cromatica · colour rendering index
2	indice di resa del rosso · red colour rendering index
3	Rf indice di fedeltà colore · colour fidelity index Rg indice di saturazione colore · color gamut index
4	step di macadam · macadam step
5	corrente di alimentazione · power supply current
6	tensione di alimentazione · power supply voltage
7	flusso luminoso · light flux
8	potenza della sorgente · source power
9	efficienza della sorgente · source efficiency
10	codice sorgente elettronica Viabizzuno · Viabizzuno led source code
11	superficie emittente · light emitting surface (mm)
12	% flusso residuo a fine vita · end life % flux
13	% consentita sotto limite · allowed % under limit

wet prodotto classificato per uso esterno · product classified for outdoor use

damp prodotto classificato per uso interno in ambienti umidi (bagno, sauna, ecc..) · product classified for indoor use in damp environments (bathrooms, saunas, etc.)

dry prodotto classificato per uso interno in ambienti asciutti · product classified for indoor use in dry environments

legenda simboli symbols legenda

 prodotto in conformità con le direttive nord americane sui soffioni doccia · produced in compliance with showerheads northamerican directives

 componente certificato per il mercato nord americano idoneo ad essere utilizzato e valutato come parte di in un sistema più complesso
component approved for north american market and suitable to be used and approved as part of a more complex system

 prodotto finito idoneo per essere commercializzato nel mercato nord americano · listed product suitable for the north american market

 prodotto finito idoneo per essere commercializzato nel mercato nord americano · listed product suitable for the north american market

type ic apparecchio di illuminazione ad incasso progettato per funzionare a contatto con materiale isolante.
recessed luminaire designed to work in contact with thermal insulation.

type non-ic apparecchio di illuminazione ad incasso progettato per funzionare in intercapedini che abbiano una certa distanza da materiali isolanti.
recessed luminaire designed to work in cavities that have a minimum dimensions and spacings to thermal insulation.

title24 prodotto conforme allo standard title24 · product compliant with title24 standard

 vetro opalino · opal glass

 vetro sabbiato · sanded glass

 vetro nero fumè · black smoke glass

 vetro trasparente · transparent glass

 vetro bianco latte · white milk glass

 cristallo · crystal

 policarbonato opalino · opal polycarbonate diffuser

 carrabile · drive over

A alimentatore incluso · power supply included

A alimentatore escluso · power supply not included

AR alimentatore remoto incluso · remote power supply included

Ai alimentatore elettronico con controllo intelligente incluso · electronic power supply with smart control included

AiR alimentatore elettronico con controllo intelligente incluso, da installare remoto · electronic power supply with smart control included, to be installed remotely

AS alimentatore a spina incluso · plug power supply included

T trasformatore incluso · transformer included

K kit di cablaggio incluso · wiring kit not included

K kit di cablaggio escluso · wiring kit not included

L lampadina con sorgente elettronica led, ad incandescenza, alogena o fluorescente inclusa.
bulb with led electronic source, incandescent, halogen or fluorescent included.

L lampadina con sorgente elettronica led, ad incandescenza, alogena o fluorescente esclusa.
bulb with led electronic source, incandescent, halogen or fluorescent not included.

PR propulsore dinamico n55 incluso · included

 attenzione: sorgente luminosa led. non guardare mai direttamente a occhio nudo · attention: led light source. never look straight without eye protection

i peso netto · net weight (kg)

 possibilità di combinazione tra interfaccia n55, propulsore dinamico n55 e lampadina n55 · possible combination between n55 interface, propulsore dinamico n55 and n55 bulb

I.d. luce diretta · direct light

I.i. luce indiretta · indirect light

V  disponibile su · available on *Viabizzuno applight* www.Viabizzuno.com *Viabizzuno online*