



Viabizzuno strada principale della frazione di bizzuno in provincia di ravenna dove tra la casa del popolo e la parrocchia, al n°17, sono nato il ventuno luglio millenovecentocinquantacinque. da qui nasce il nome della fabbrica di produzione fondata nel millenovecentonovantaquattro rappresentata da uno spazio bianco attraversato da due linee. una verticale, rigorosa, essenziale, equilibrata: la luce per la luce; ed una inclinata, irriverente nello spazio, ironica, fuori dagli schemi: la luce per la forma. distinte ma complementari si fondono in un unico nome: Viabizzuno.

marionanni

Viabizzuno is the name of the main road of the small village bizzuno located in the province of ravenna, where I was born on the twenty-first july nineteenfiftyfive at n°17, between the 'casa del popolo' and the local parish church. from here the name of the factory founded in nineteen ninety-four represented by a white space intersected by two lines. one vertical, well balanced, logical, essential: the light for the light. the other one dynamic, irreverent, ironic: the light for the form. separate and yet complementary they cast in the same name: Viabizzuno.

prodotto
product



schede tecniche
technical data sheets



curve fotometriche
photometric curves



modelli 3d per i tuoi render
3d models for your render





**apparecchio di illuminazione a sospensione e terra per interni.
realizzato con profili calandrati in ottone naturale di sezione 10x10mm/0.4x0.4" di forma cilindrica o ellittica di diverse dimensioni distanziati fra loro da anelli in ottone diametro Ø80mm/3.1" con lenti biconcave.**

all'interno dell'apparecchio di illuminazione sono installati due profili di ottone di sezione 10x3mm/0.4x0.1" che creano un binario elettrificato per alimentare le sorgenti elettroniche 2700K Ra95 a luce diffusa, completi di tige di diverse altezze, di supporto al diffusore in cristallo trasparente.

modelli:

**da ma sospensione 18 lenti su 4 file,
diametro Ø430mm/16.9" h.330mm/13", 8x2,5W,**

**da ma sospensione 32 lenti su 6 file,
diametro Ø760mm/29.9" h.490mm/19.3", 14x2,5W,**

**da ma sospensione 66 lenti su 8 file,
diametro Ø1520mm/59.4" h.650mm/25.6", 32x2,5W,**

**da ma sospensione 64 lenti su 4 file,
ellittica 2100x380mm/82.7x15" h.330mm/13", 32x2,5W,**

**da ma sospensione 60 lenti su 6 file,
ellittica 1760x760mm/69.3x29.9" h.490mm/19.3", 32x2,5W.**

alimentatore escluso, da installare remoto.

kit di fissaggio a sospensione escluso.

**da ma terra 01 con base in acciaio e asta di sostegno di sezione quadrata ricoperta in pelle,
di dimensioni 640x430x2000mm/25.2x16.9x78.72, potenza 14x2,5W
alimentatore 120 50-60Hz incluso.**

finiture: ottone naturale.

dry location rated suspension and floor standing light fitting for indoor use.

made of natural brass calandered profiles of different sizes with a section of 10x10mm/0.4x0.4" and a cylindrical or elliptical shape, separated by diameter Ø80mm/3.1" brass rings with biconcave lenses.

the light fitting contains two brass profiles with 10x3mm/0.4x0.1" section, which create an electrified track to power the 2700K Ra95 electronic sources for diffused light, equipped with rods of different heights supporting the transparent crystal diffuser to create evocative lighting effects.

versions:

**da ma sospensione 18 lense on 4 rows,
diameter Ø430mm/16.9" h.330mm/13", 8x2.5W,**

**da ma sospensione 32 lense on 6 rows,
diameter Ø760mm/29.9" h.490mm/19.3", 14x2.5W,**

**da ma sospensione 66 lense on 8 rows,
diameter Ø1520mm/59.4" h.650mm/25.6", 32x2.5W,**

**da ma sospensione 64 lense on 4 rows,
elliptical 2100x380mm/82.7x15" h.330mm/13", 32x2.5W,**

**da ma sospensione 60 lense on 6 rows,
power supply not included, to be installed remotely.**

kit for suspended installation not included.

**da ma terra 01 with steel base and a square section leather covered rod,
640x430x2000mm/25.2x16.9x78.72, 14x2.5W power;**

**elliptical 1760x760mm/69.3x29.9" h.499mm/19.3", 32x2.5W.
120V 50-60Hz power supply included.**

finishes: natural brass.



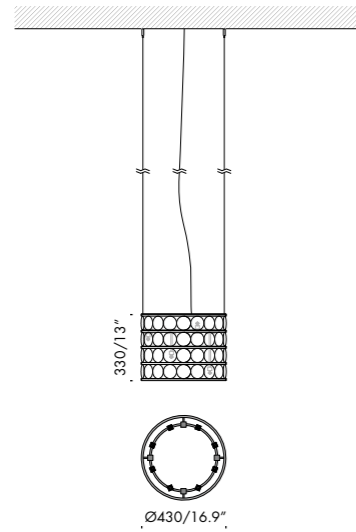

da ma sospensione 18x4 24Vdc    

a8.532.11.u ottone naturale con lenti biconcave 2700K 8x2,5W 20kg
 natural brass with biconcave lenses 44lb

Ra	R9	ies tm/30		sdcm	Vf	lm	W	lm/W
95	90	Rf 93	Rg 102	step 2	24,0	1920	20	96
Vz010-8	les16	Ta25 °C		vita media · average life		50000 h	L80	B10

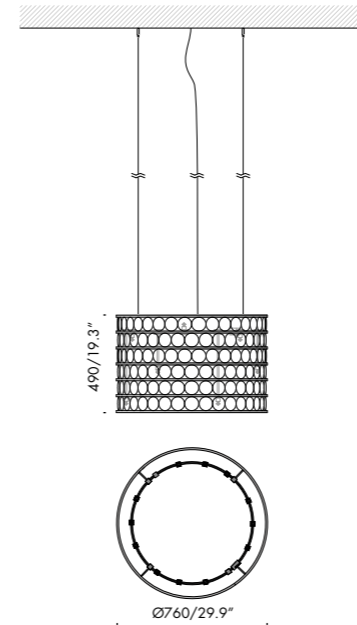

da ma sospensione 32x6 24Vdc    

a8.532.12.u ottone naturale con lenti biconcave 2700K 14x2,5W 47kg
 natural brass with biconcave lenses 103.6lb

Ra	R9	ies tm/30		sdcm	Vf	lm	W	lm/W
95	90	Rf 93	Rg 102	step 2	24,0	3360	35	96
Vz010-14	les16	Ta25 °C		vita media · average life		50000 h	L80	B10

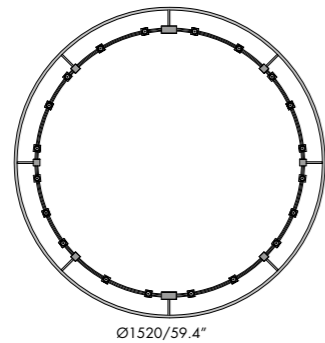
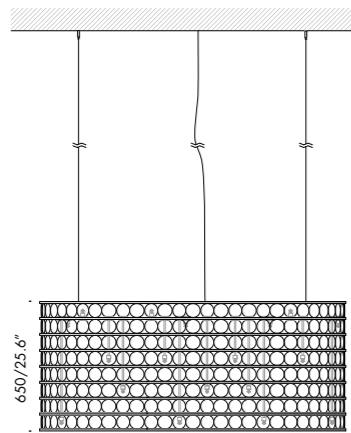





da ma sospensione 66x8 24Vdc    

a8.532.13.u ottone naturale con lenti biconcave 2700K 32x2,5W 126kg
 natural brass with biconcave lenses 278lb

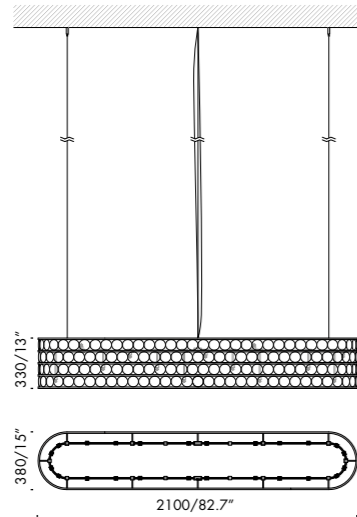
Ra	R9	ies tm/30		sdc	Vf	lm	W	lm/W
95	90	Rf 93	Rg 102	step 2	24,0	7680	80	96
Vz010-32	les16 	Ta25 °C		vita media · average life	50000 h		L80 B10	







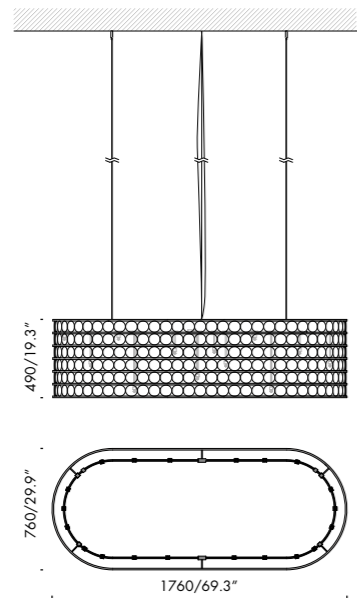

da ma sospensione 64x4 24Vdc     dry

a8.532.14.u ottone naturale con lenti biconcave 2700K 32x2,5W 62kg
natural brass with biconcave lenses 137lb

Ra	R9	ies tm/30		sdc	Vf	lm	W	lm/W
95	90	Rf 93	Rg 102	step 2	24,0	7680	80	96
Vz010-32	les16	Ta25 °C		vita media - average life		50000 h	L80	B10



da ma sospensione 60x6 24Vdc     dry

a8.532.15.u ottone naturale con lenti biconcave 2700K 32x2,5W 86kg
natural brass with biconcave lenses 190lb

Ra	R9	ies tm/30		sdc	Vf	lm	W	lm/W
95	90	Rf 93	Rg 102	step 2	24,0	7680	80	96
Vz010-32	les16	Ta25 °C		vita media - average life		50000 h	L80	B10



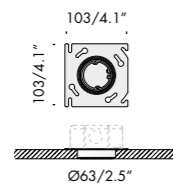



copertura per outlet box. cover for outlet box  

Vb9.000.01.u scomparsa totale cartongesso 0,3kg
fully concealed for plasterboard installation" 0.7lb

accessori. accessories.  

a9.532.84 kit di fissaggio cavi incasso per scomparsa totale 0,5kg
fixing kits for cable for recessed installing 1.1lb

alimentatori. power supplies. 120-277V 50-60Hz **damp**  

t4.630.u 24V dimm. 0-10V 96W 0,8kg
1.8lb

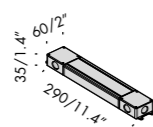
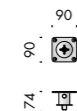

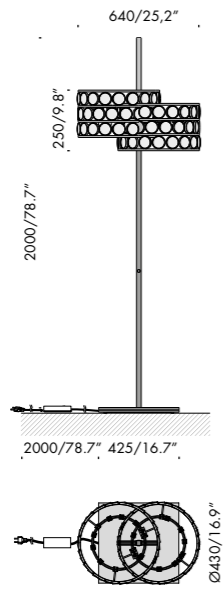

da ma terra 01 120V 50-60Hz

Vb4.532.31.u ottone naturale con lenti biconcave e asta ricoperta in pelle
 natural brass with biconcave lenses and leather coated rod 2700K 14x2,5W 85kg 187lb

Ra	R9	ies tm/30		sdcm	Vf	lm	W	lm/W
95	90	Rf 93	Rg 102	step 2	24,0	3360	35	96
Vz010-14	les16	Ta25 °C		vita media · average life		50000 h	L80 B10	

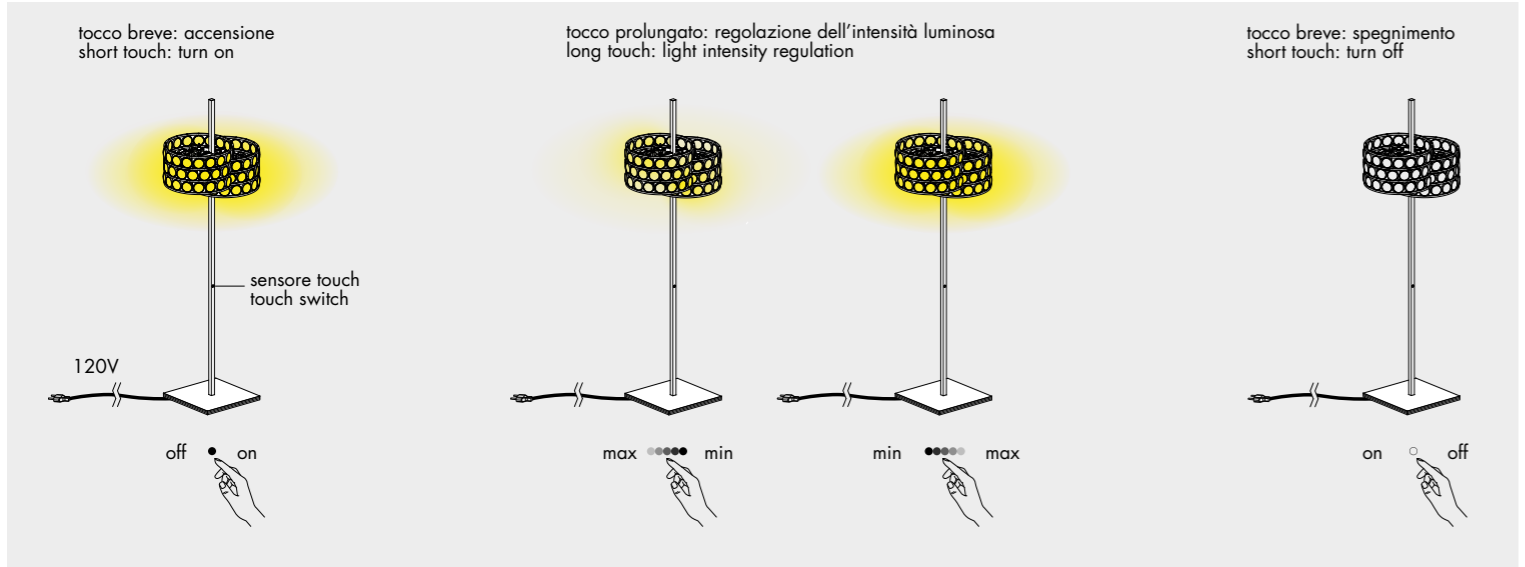

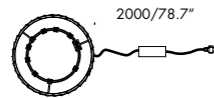
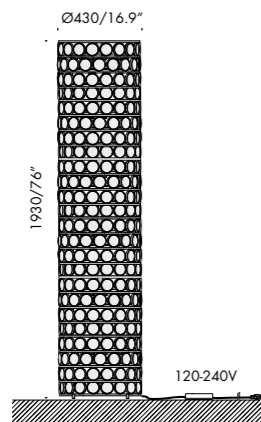

da ma terra colonna 120-240V 50-60Hz A dry

Vb4.532.51 ottone naturale con lenti biconcave 2700K 28x2,5W 104kg
 natural brass with biconcave lenses 229lb

Ra	R9	ies tm/30		sdc	Vf	lm	W	lm/W
95	90	Rf 93	Rg 102	step 2	24,0	6720	70	96
Vz010-28	les16	Ta25 °C		vita media · average life		50000 h	L80 B10	







lettura delle tabelle tecniche how to read technical tables

xxxxxxxxxxxxxxxx				120V 50-60Hz	A	wet	UL	UL US	i
a	b	c	d	e	f	f	g		

xxxxxxxxxxxxxxxx				120V 50-60Hz	A	wet	UL	UL US	i
Vbx.xxx.xx	nero55	3000K	35W	20°	0,8kg	1.8lb			
h	i	l	m	n	g				

componenti. components.

accessori. accessories.

1	2	3	4	5	6	7	8	9	
Ra	R9	ies tm-30		sdc	mA	V _{f (min)}	lm	W	lm/W
98	98	Rf 96	Rg 103	step 1	350	27,6	1240	9,7	128
					500	27,9	1580	14,0	113
xm000	les19	Ta25 °C		vita media · average life		50000 h	L80	B10	
10	11						12	13	

classificazione ambiente di installazione installation location rating

bandella tecnica. posizioni standard simbologie.
data plate. standard arrangement of symbols.

a	nome apparecchio di illuminazione · light fitting name
b	tensione di alimentazione · supply rating (Volt)
c	frequenza di alimentazione · supply frequency (Hertz)
d	alimentatore incluso o escluso · power supply included or not included
e	classificazione ambiente di installazione · installation location rating
f	marchio di certificazione · safety and quality standards certification
g	peso netto · net weight (kg/lb)
h	codice · code
i	finiture · colours and finishes
l	temperatura colore sorgente elettronica colour temperature led source (Kelvin)
m	potenza della sorgente · source power (Watt)
n	gradi fascio luminoso · light beam degrees

componenti. identifica tutti gli elementi indispensabili per la corretta funzionalità e installazione dell'apparecchio di illuminazione.
components. includes all items that are essential to the correct operation and installation of the light fitting.

accessori. si riferisce alle ulteriori parti installabili sull'apparecchio.
accessories. refers to items that can be added to the light fitting.

1	indice di resa cromatica · colour rendering index
2	indice di resa del rosso · red colour rendering index
3	Rf indice di fedeltà colore · colour fidelity index Rg indice di saturazione colore · color gamut index
4	step di macadam · macadam step
5	corrente di alimentazione · power supply current
6	tensione di alimentazione · power supply voltage
7	flusso luminoso · light flux
8	potenza della sorgente · source power
9	efficienza della sorgente · source efficiency
10	codice sorgente elettronica Viabizzuno · Viabizzuno led source code
11	superficie emittente · light emitting surface (mm)
12	% flusso residuo a fine vita · end life % flux
13	% consentita sotto limite · allowed % under limit

wet prodotto classificato per uso esterno · product classified for outdoor use

damp prodotto classificato per uso interno in ambienti umidi (bagno, sauna, ecc..) · product classified for indoor use in damp environments (bathrooms, saunas, etc.)

dry prodotto classificato per uso interno in ambienti asciutti · product classified for indoor use in dry environments

legenda simboli symbols legenda

 prodotto in conformità con le direttive nord americane sui soffioni doccia · produced in compliance with showerheads northamerican directives

 componente certificato per il mercato nord americano idoneo ad essere utilizzato e valutato come parte di in un sistema più complesso
component approved for north american market and suitable to be used and approved as part of a more complex system

 prodotto finito idoneo per essere commercializzato nel mercato nord americano · listed product suitable for the north american market

 prodotto finito idoneo per essere commercializzato nel mercato nord americano · listed product suitable for the north american market

type ic apparecchio di illuminazione ad incasso progettato per funzionare a contatto con materiale isolante.
recessed luminaire designed to work in contact with thermal insulation.

type non-ic apparecchio di illuminazione ad incasso progettato per funzionare in intercapedini che abbiano una certa distanza da materiali isolanti.
recessed luminaire designed to work in cavities that have a minimum dimensions and spacings to thermal insulation.

title24 prodotto conforme allo standard title24 · product compliant with title24 standard

 vetro opalino · opal glass

 vetro sabbiato · sanded glass

 vetro nero fumè · black smoke glass

 vetro trasparente · transparent glass

 vetro bianco latte · white milk glass

 cristallo · crystal

 policarbonato opalino · opal polycarbonate diffuser

 carrabile · drive over

A alimentatore incluso · power supply included

A alimentatore escluso · power supply not included

AR alimentatore remoto incluso · remote power supply included

Ai alimentatore elettronico con controllo intelligente incluso · electronic power supply with smart control included

AiR alimentatore elettronico con controllo intelligente incluso, da installare remoto · electronic power supply with smart control included, to be installed remotely

AS alimentatore a spina incluso · plug power supply included

T trasformatore incluso · transformer included

K kit di cablaggio incluso · wiring kit not included

K kit di cablaggio escluso · wiring kit not included

L lampadina con sorgente elettronica led, ad incandescenza, alogena o fluorescente inclusa.
bulb with led electronic source, incandescent, halogen or fluorescent included.

L lampadina con sorgente elettronica led, ad incandescenza, alogena o fluorescente esclusa.
bulb with led electronic source, incandescent, halogen or fluorescent not included.

PR propulsore dinamico n55 incluso · included

 attenzione: sorgente luminosa led. non guardare mai direttamente a occhio nudo · attention: led light source. never look straight without eye protection

i peso netto · net weight (kg)

 possibilità di combinazione tra interfaccia n55, propulsore dinamico n55 e lampadina n55 · possible combination between n55 interface, propulsore dinamico n55 and n55 bulb

I.d. luce diretta · direct light

I.i. luce indiretta · indirect light

V  disponibile su · available on *Viabizzuno applight* www.Viabizzuno.com *Viabizzuno online*