

Viabizzuno progettiamo la luce

Viabizzuno strada principale della frazione di bizzuno in provincia di ravenna dove tra la casa del popolo e la parrocchia, al n°17, sono nato il ventuno luglio millenovecentocinquantacinque. da qui nasce il nome della fabbrica di produzione fondata nel millenovecentonovantaquattro rappresentata da uno spazio bianco attraversato da due linee. una verticale, rigorosa, essenziale, equilibrata: la luce per la luce; ed una inclinata, irriverente nello spazio, ironica, fuori dagli schemi: la luce per la forma. distinte ma complementari si fondono in un unico nome: Viabizzuno.

Viabizzuno is the name of the main road of the small village bizzuno located in the province of ravenna, where I was born on the 21 07 1955 at n°17, between the 'casa del popolo' and the local parish church. from here the name of the factory founded in nineteen ninety-four represented by a white space intersected by two lines. one vertical, well balanced, logical, essential: the light for the light. the other one dynamic, irreverent, ironic: the light for the form. separate and yet complementary they cast in the same name: Viabizzuno. mario nanni

*i progetti rendono gli oggetti eterni,
le mode li corrompono, gli imbecilli li copiano
e li vendono agli ignoranti e ai deficienti.
noi progettiamo e lavoriamo per aiutare la luce
ad emozionarvi.*

*i frutti delle nostre idee e dei nostri progetti
sono protetti da brevetti
e/o modelli registrati
e/o da diritto d'autore.*

design makes objects timeless,
fashion corrupts them,
fools copy them and sell them to
ignorants and idiots.
we do projects and work to help light to bring
you true emotion.
the results of our ideas and our projects
are protected by patents
and/or registered models
and/or copyright.

al fine di offrire ai nostri clienti la massima qualità della luce utilizzando le più avanzate tecnologie, forti del nostro sapere artigiano costruito in Italia, aggiorniamo costantemente i nostri apparecchi di illuminazione.

Viabizzuno si riserva il diritto di apportare ai propri modelli, senza nessun preavviso, qualsiasi modifica ritenesse opportuna. per dimensioni e codici fanno fede i nostri strumenti di lavoro www.Viabizzuno.com, [Viacommerce@](mailto:Viacommerce@viabizzuno.com), [Viabizzunoapplight](http://Viabizzunoapplight.com) e [Viabizzunoonline](http://Viabizzunoonline.com).

la progettazione degli apparecchi di illuminazione e dei relativi componenti è eseguita utilizzando i millimetri come unità di misura. le dimensioni espresse in pollici sono indicative e frutto di conversioni soggette a tolleranze.

in order to provide to our customers the maximum quality of light using the most advanced technologies, being strong of our artisan knowledge made in Italy, we constantly update our lighting fixtures.

Viabizzuno reserves the right to make any modification, considered worthwhile, to its own models, without any notification. for valid dimensions and codes please consult our working tools www.Viabizzuno.com, [Viacommerce@](mailto:Viacommerce@viabizzuno.com), [Viabizzunoapplight](http://Viabizzunoapplight.com) and [Viabizzunoonline](http://Viabizzunoonline.com).

when designing lighting fixtures and related components, the unit of measure used is the millimetre. dimensions expressed in inches are indicative and are the result of conversions subject to tolerances.

legenda simboli symbols legenda



prodotto in conformità con le direttive nord americane sui soffioni doccia · produced in compliance with showerheads northamerican directives



componente certificato per il mercato nord americano idoneo ad essere utilizzato e valutato come parte di un sistema più complesso
component approved for north american market and suitable to be used and approved as part of a more complex system



prodotto finito idoneo per essere commercializzato nel mercato nord americano · listed product suitable for the north american market



prodotto finito idoneo per essere commercializzato nel mercato nord americano · listed product suitable for the north american market



pending

apparecchio di illuminazione in corso di certificazione per essere commercializzato nel mercato nord americano
light fitting undergoing certification to be marketed in the north american market

wet

prodotto classificato per uso esterno · product classified for outdoor use

damp

prodotto classificato per uso interno in ambienti umidi (bagno, sauna, ecc..) · product classified for indoor use in damp environments (bathrooms, saunas, etc.)

dry

prodotto classificato per uso interno in ambienti asciutti · product classified for indoor use in dry environments

type ic

apparecchio di illuminazione ad incasso progettato per funzionare a contatto con materiale isolante.
recessed luminaire designed to work in contact with thermal insulation.

type non-ic

apparecchio di illuminazione ad incasso progettato per funzionare in intercapedini che abbiano una certa distanza da materiali isolanti.
recessed luminaire designed to work in cavities that have a minimum dimensions and spacings to thermal insulation.

title24

prodotto conforme allo standard title24 · product compliant with title24 standard



vetro opalino · opal glass



vetro sabbiato · sanded glass



vetro nero fumè · black smoke glass



vetro trasparente · transparent glass



vetro bianco latte · white milk glass



crystallo · crystal



policarbonato opalino · opal polycarbonate diffuser



carrabile · drive over

a

fascio asimmetrico · asymmetric beam

e

fascio ellittico · elliptical beam

w

wallwasher

- A** alimentatore incluso · power supply included
- A** alimentatore escluso · power supply not included
- AR** alimentatore remoto incluso · remote power supply included
- Ai** alimentatore elettronico con controllo intelligente incluso · electronic power supply with smart control included
- AiR** alimentatore elettronico con controllo intelligente incluso, da installare remoto · electronic power supply with smart control included, to be installed remotely
- AS** alimentatore a spina incluso · plug power supply included
- T** trasformatore incluso · transformer included
- K** kit di cablaggio incluso · wiring kit not included
- K** kit di cablaggio escluso · wiring kit not included
- L** lampadina con sorgente elettronica led, ad incandescenza, alogena o fluorescente inclusa.
bulb with led electronic source, incandescent, halogen or fluorescent included.
- L** lampadina con sorgente elettronica led, ad incandescenza, alogena o fluorescente esclusa.
bulb with led electronic source, incandescent, halogen or fluorescent not included.
- pr** propulsore dinamico n55 incluso · included
-  attenzione: sorgente luminosa led. non guardare mai direttamente a occhio nudo · attention: led light source. never look straight without eye protection
- i** peso netto · net weight (kg)
-  possibilità di combinazione tra interfaccia n55, propulsore dinamico n55 e lampadina n55 · possible combination between n55 interface, propulsore dinamico n55 and n55 bulb
- l.d.** luce diretta · direct light
- l.i.** luce indiretta · indirect light
- V** disponibile su · available on *Viabizzuno applight* www.Viabizzuno.com *Viabizzuno online*

lampada quadra " ...l'ho voluta di forma quadrata, perfetta. " ag fronzoni 1962



**apparecchio di illuminazione a parete o soffitto per interni.
costituito da schermo in acciaio 220x220mm/8.6x8.6" e struttura di supporto 110mm/4.3".
cablato con sorgente elettronica 2700K Ra98 fino a 16,8W 1714lm
o 3000K Ra98 fino a 16,8W 1810lm,
emette luce diffusa indiretta e crea un punto di luce sulla parte a vista grazie ad un
microforo quadrato centrale.
alimentatore 120V a corrente costante escluso, da installare remotely.
finiture: my bianco, nero55, inox lucido.**

**damp rated wall or ceiling light fitting for indoor use.
consisting of a 220x220mm/8.6x8.6" steel shield and 110mm/4.3" support.
wired with 2700K Ra98 up to 16,8W 1714lm
or 3000K Ra98 up to 16,8W 1810lm led source,
it emits diffuse indirect light and creates a spot light on the exposed part thanks to a
central square microhole.
120V constant current power supply not included, to be installed remotely.
finishes: my bianco, nero55, polished stainless steel.**

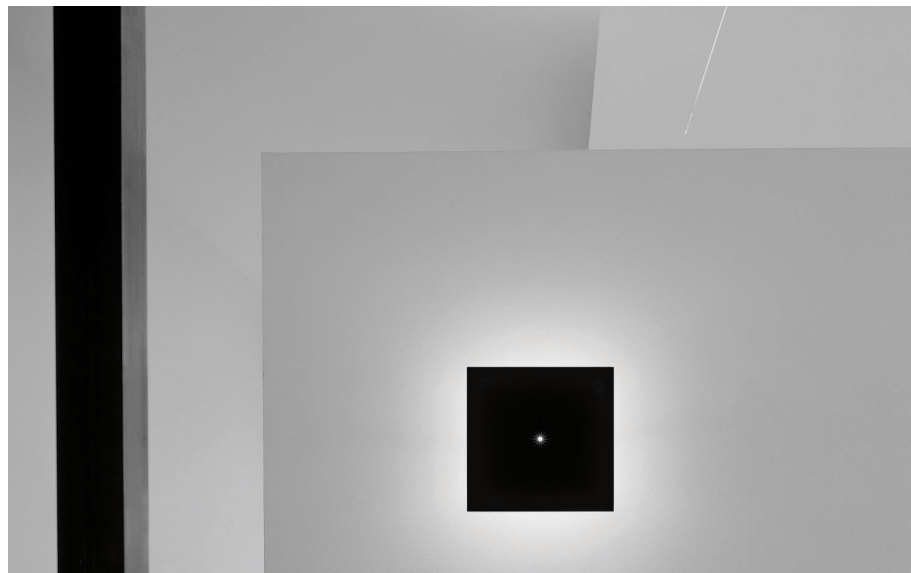

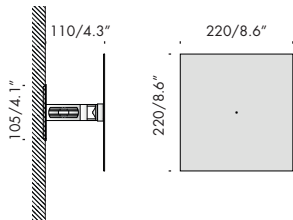



lampada quadra  **damp**   

Vb6.115.01.27	my bianco	2700K	1,5kg 3.3lb
Vb6.115.02.27	nero55	2700K	1,5kg 3.3lb
Vb6.115.03.27	inox lucido · polished stainless steel	2700K	1,5kg 3.3lb

Ra	R9	ies tm-30		sdcM	mA	V _{f (min)}	lm	W	lm/W
98	90	Rf 93	Rg 99	step 2	350	32,8	1233	11,5	108
					500	33,6	1714	16,8	102
ce060	les12 ●	Ta25 °C		vita media · average life		50000 h	L80	B10	

Vb6.115.01.30	my bianco	3000K	1,5kg 3.3lb
Vb6.115.02.30	nero55	3000K	1,5kg 3.3lb
Vb6.115.03.30	inox lucido · polished stainless steel	3000K	1,5kg 3.3lb

Ra	R9	ies tm-30		sdcM	mA	V _{f (min)}	lm	W	lm/W
98	90	Rf 93	Rg 99	step 2	350	32,8	1302	11,5	114
					500	33,6	1810	16,8	108
ce061	les12 ●	Ta25 °C		vita media · average life		50000 h	L80	B10	

alimentatori. power supplies. **120V**  **IP20**  

134002	500mA	dimm. 0-10V	21W	0,2kg 0.4lb
---------------	-------	-------------	-----	----------------

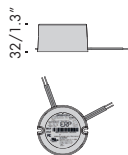

installazione con alimentatore remoto · installation with remote power supply

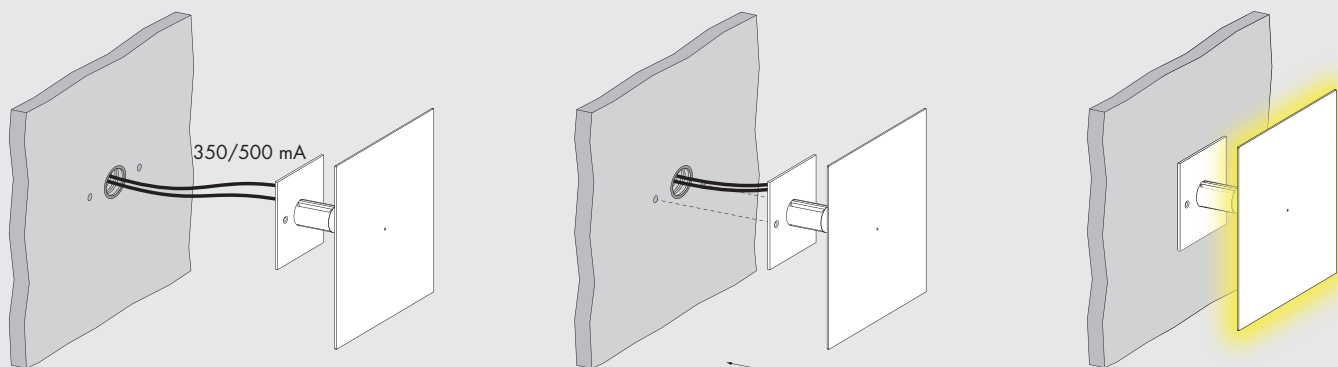

installazione con scatola modello usa/canada · installation with usa/canada outlet box

