



*Viabizzuno strada principale della frazione di bizzuno in provincia di ravenna dove tra la casa del popolo e la parrocchia, al n°17, sono nato il ventuno luglio millenovecentocinquantacinque. da qui nasce il nome della fabbrica di produzione fondata nel millenovecentonovantaquattro rappresentata da uno spazio bianco attraversato da due linee. una verticale, rigorosa, essenziale, equilibrata: la luce per la luce; ed una inclinata, irriverente nello spazio, ironica, fuori dagli schemi: la luce per la forma. distinte ma complementari si fondono in un unico nome: Viabizzuno.*

*marionanni*

Viabizzuno is the name of the main road of the small village bizzuno located in the province of ravenna, where I was born on the twenty-first july nineteenfiftyfive at n°17, between the 'casa del popolo' and the local parish church. from here the name of the factory founded in nineteen ninety-four represented by a white space intersected by two lines. one vertical, well balanced, logical, essential: the light for the light. the other one dynamic, irreverent, ironic: the light for the form. separate and yet complementary they cast in the same name: Viabizzuno.

prodotto  
product



schede tecniche  
data sheets



curve fotometriche  
photometric curves



modelli 3d per i tuoi render  
3d models for your render





**apparecchio di illuminazione a parete o soffitto per interni realizzato in alluminio ossidato.**

**modelli:**

**n55 parete soffitto orientabile con alimentatore 120V 50-60Hz integrato 60x155mm/2.4x6.1"**

**h.133mm/5.2"**,

**n55 parete soffitto orientabile con alimentatore escluso, diametro Ø80mm/3.1" con tige**

**h.100mm/3.9"**,

**n55 parete soffitto scomparsa totale orientabile con alimentatore escluso, con tige**

**h.100mm/3.9"**.

**in tutte le versioni la tige è di diametro Ø10mm/0.5" con interfaccia orientabile di diametro Ø55mm/2.1"**.

**da abbinare ai seguenti propulsori dinamici n55:**

**55/350e les19 fino a 9,7W 350mA 1240lm,**

**55/350 les19 fino a 9,7W 350mA 1240lm,**

**55/500 les19 fino a 14W 500mA 1580lm,**

**55/500 les9 fino a 13,6W 500mA 800lm,**

**65/500e les19 fino a 14W 500mA 1580lm,**

**65/700 les19 fino a 19,9W 700mA 2140lm,**

**65/700 les9 fino a 19,5W 700mA 1110lm,**

**82/1050 les19 fino a 30,5W 1050mA 3000lm.**

**tutti i propulsori sono Ra98 1 step macadam con sorgente elettronica 2700K, 3000K o 3000Vb K (progettato per il settore alta moda).**

**l'apposito attacco n55 permette di intercambiare tre tipi di lampadina: classica, decorativa e tecnica. eventuali irregolarità del vetro sono garanzia di un prodotto unico, soffiato e realizzato interamente a mano da maestri vetrai.**

**la versione con alimentatore integrato è fornita di controllo intelligente che regola automaticamente la corrente al tipo di propulsore. lo stesso alimentatore può essere ordinato a parte per le altre versioni.**

**finiture: argento hacca, nero55, my bianco.**

**diffusori classici e decorativi con vetro trasparente, sabbiato e bianco latte.**

**personalizza la tua luce vai su [www.Viabizzuno.com](http://www.Viabizzuno.com)**

**damp location rated wall or ceiling light fitting for indoor use made of oxidised aluminium.**

**versions:**

**n55 parete soffitto orientabile with 120V integrated power supply 60x155mm/2.4x6.1"**

**h.133mm/5.2"**,

**n55 parete soffitto orientabile with power supply not included, Ø80mm/3.1" with**

**h.100mm/3.9" rod,**

**n55 parete soffitto scomparsa totale orientabile with power supply not included, with**

**h.100mm/3.9" rod;**

**in all versions the rod has a 10mm diameter with a Ø55mm/2.1" adjustable interface. which can be paired with the following propulsori dinamici n55:**

**55/350e les19 up to 9.7W 350mA 1240lm,**

**55/350 les19 up to 9.7W 350mA 1240lm,**

**55/500 les19 up to 14W 500mA 1580lm,**

**55/500 les9 up to 13.6W 500mA 800lm,**

**65/500e les19 up to 14W 500mA 1580lm,**

**65/700 les19 up to 19.9W 700mA 2140lm,**

**65/700 les9 up to 19.5W 700mA 1110lm,**

**82/1050 les19 up to 30.5W 1050mA 3000lm.**

**all propellers are Ra98 1 step macadam with 2700K, 3000K or 3000Vb K electronic source (designed for high fashion industry).**

**the specific n55 lamp-holder allows to change three types of light bulbs: classic, decorative and technical. any irregularities in the glass are a guarantee of an unique product, blown and entirely hand crafted by master glassmakers.**

**the version with integrated power supply has a special intelligent control which automatically provides the suitable current according to the type of propeller. the same power supply can also be ordered separately for the other versions.**

**finishes: argento hacca, nero55, my bianco.**

**classic and decorative diffuser with transparent, sanded and milk white glass.**

**customize your light visit [www.Viabizzuno.com](http://www.Viabizzuno.com)**

brevettato · patented



*personalizza la tua luce  
vai su Viabizzuno.com*

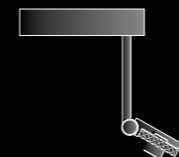

+



+



*diffusore decorativo  
decorative diffuser*



*diffusore tecnico  
technical diffuser*

customize your light visit [Viabizzuno.com](https://www.viabizzuno.com)

**1. scegli l'interfaccia  
choose the interface**

**2. scegli il propulsore dinamico n55  
choose the propulsore dinamico n55**

**3. scegli il tuo diffusore classico, decorativo e tecnico  
choose your classic, decorative and technical diffuser**

**n55 parete soffitto orientabile**

**propulsore dinamico n55**

**diffusore classico  
classic diffuser**

**diffusore decorativo  
decorative diffuser**

**diffusore tecnico  
technical diffuser**

**n55 parete soffitto orientabile a.i. †  
interfaccia**  
alimentatore integrato  
integrated power supply

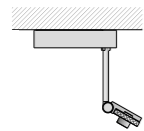

**n55 parete soffitto orientabile a.r. †  
interfaccia**  
alimentatore incassato  
recessed power supply

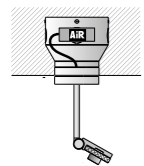

**n55 parete soffitto orientabile a.r. †  
interfaccia**  
alimentatore remoto  
remote power supply

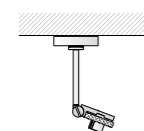

**n55 parete soffitto orientabile a.r. †  
interfaccia**  
alimentatore remoto con rosone scomparsa totale  
remote power supply with fully concealed rose

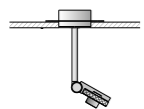

**55/350e †**  
les19 ●  
350mA  
1240lm  
9,7W  
128lm/W



**55/350 †**  
les19 ●  
350mA  
1240lm  
9,7W  
128lm/W



**55/500 †**  
les19 ●  
500mA  
1580lm  
14W  
113lm/W



**55/500 †**  
les9 ●  
500mA  
800lm  
13,6W  
59lm/W



**65/500e †**  
les19 ●  
500mA  
1580lm  
14W  
113lm/W



**65/700 †**  
les19 ●  
700mA  
2140lm  
19,9W  
108lm/W



**65/700 †**  
les9 ●  
700mA  
1110lm  
19,5W  
57lm/W



**82/1050 †**  
les19 ●  
1050mA  
3000lm  
30,5W  
98lm/W

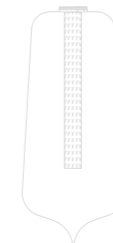
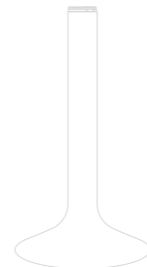
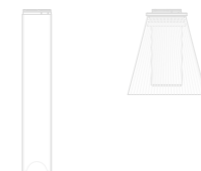

**spot35 †**  
les19 ● 87°  
les9 ● 18° 23° 36°



**spot55x37 †**  
les19 ● 30° 38°  
les9 ● 18° 23° 36°



**spot55x61 †**  
les19 ● 36° 47°  
les9 ● 18° 23° 36°



**spot82x35 †**  
les19 ● 31° 42°  
les9 ● 13° 19° 23° 35°



**spot82x79 †**  
les19 ● 23° 37° 46°  
les9 ● 13° 19° 23° 35°



**spot100 †**  
les19 ● 16° 25° 40° 54°  
les9 ● 10° 22°



**lensoptica amP150 †**  
les19 ● 22° 51°  
les9 ● 13°



**lensoptica amP180 †**  
les19 ● 15° 41° 53° 20°x55°  
les9 ● 10°





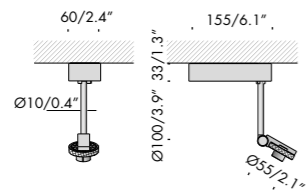

**n55 parete soffitto orientabile interfaccia 120V 50-60Hz** title24 damp

<b>Vb6.580.05.u</b>	argento hacca	n55	0,7kg 1.5lb
<b>Vb6.580.06.u</b>	nero55	n55	0,7kg 1.5lb
<b>Vb6.580.07.u</b>	my bianco	n55	0,7kg 1.5lb

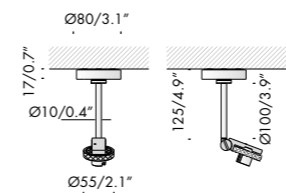

**n55 parete soffitto orientabile interfaccia** title24 damp

<b>Vb6.580.13</b>	argento hacca	n55	0,5kg 1.1lb
<b>Vb6.580.14</b>	nero55	n55	0,5kg 1.1lb
<b>Vb6.580.15</b>	my bianco	n55	0,5kg 1.1lb

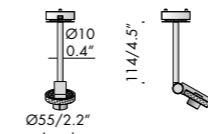

**n55 parete soffitto orientabile interfaccia scomparsa totale** title24 damp

<b>Vb6.580.09</b>	argento hacca	n55	0,5kg 1.1lb
<b>Vb6.580.10</b>	nero55	n55	0,5kg 1.1lb
<b>Vb6.580.11</b>	my bianco	n55	0,5kg 1.1lb

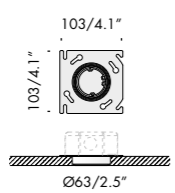

**copertura tonda per outlet box. round cover for outlet box**

<b>Vb9.000.01.u</b>	scomparsa totale cartongesso fully concealed for plasterboard installation	0,3kg 0.7lb
---------------------	---	----------------

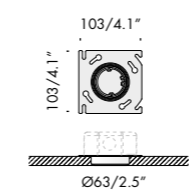

**copertura tonda per outlet box. round cover for outlet box**

<b>Vb9.000.01.u</b>	scomparsa totale cartongesso fully concealed for plasterboard installation	0,3kg 0.7lb
---------------------	---	----------------



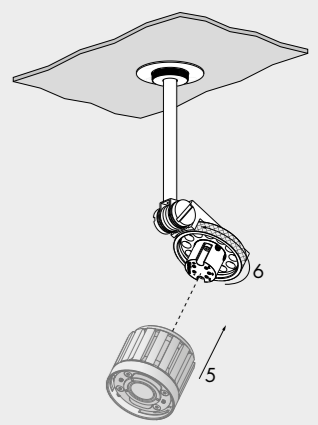
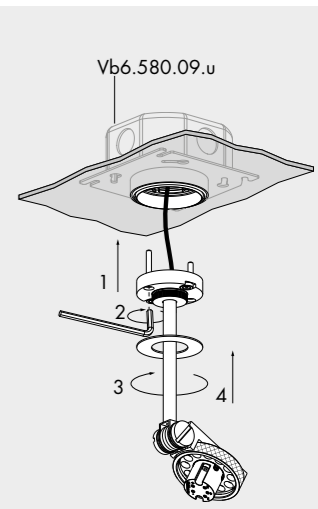

**accessori scomparsa totale. fully concealed accessories.**

<b>Vb9.580.83</b>	tappo di chiusura · end cap	argento hacca	0,1kg 0.2lb
<b>Vb9.580.84</b>	tappo di chiusura · end cap	nero55	0,1kg 0.2lb
<b>Vb9.580.85</b>	tappo di chiusura · end cap	my bianco	0,1kg 0.2lb

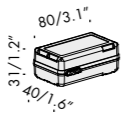



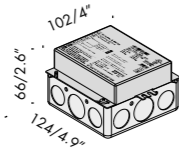

**alimentatore. power supply.** 120V 50-60Hz **Ai**   

**Vb9.580.80** alimentatore elettronico con controllo intelligente  
 electronic power supply with smart control  
 350÷1050mA dimm. 1÷10V max 34W 0,2kg  
 0.4lb



**alimentatori. power supplies.** 120V 50-60Hz **A** **dry**  

<b>t4.620.u</b>	350mA	15÷38V	13W	0,9kg 1.9lb	
<b>t4.621.u</b>	500mA	15÷38V	19W	0,9kg 1.9lb	
<b>t4.622.u</b>	700mA	15÷38V	27W	0,9kg 1.9lb	
<b>t4.623.u</b>	1050mA	15÷38V	40W	0,9kg 1.9lb	









propulsore dinamico 55/350e									
<b>Vb9.580.150.27</b>	argento hacca	2700K	les19 ●	n55	0,2kg 0.4lb				
<b>Vb9.580.151.27</b>	nero55	2700K	les19 ●	n55	0,2kg 0.4lb				
<b>Vb9.580.152.27</b>	my bianco	2700K	les19 ●	n55	0,2kg 0.4lb				

Ra	R9	ies tm-30		sdcm	mA	V <sub>f(min)</sub>	lm	W	lm/W
98	98	Rf 96	Rg 103	step 1	350	27,6	1240	9,7	128
xm000	les19 ●	Ta25 °C		vita media · average life		70000 h		L80 B10	

<b>Vb9.580.150.30</b>	argento hacca	3000K	les19 ●	n55	0,2kg 0.4lb				
<b>Vb9.580.151.30</b>	nero55	3000K	les19 ●	n55	0,2kg 0.4lb				
<b>Vb9.580.152.30</b>	my bianco	3000K	les19 ●	n55	0,2kg 0.4lb				

Ra	R9	ies tm-30		sdcm	mA	V <sub>f(min)</sub>	lm	W	lm/W
98	98	Rf 96	Rg 103	step 1	350	27,6	1240	9,7	128
xm001	les19 ●	Ta25 °C		vita media · average life		70000 h		L80 B10	

<b>Vb9.580.150.30v</b>	argento hacca	3000VbK	les19 ●	n55	0,2kg 0.4lb				
<b>Vb9.580.151.30v</b>	nero55	3000VbK	les19 ●	n55	0,2kg 0.4lb				
<b>Vb9.580.152.30v</b>	my bianco	3000VbK	les19 ●	n55	0,2kg 0.4lb				

Ra	R9	ies tm-30		sdcm	mA	V <sub>f(min)</sub>	lm	W	lm/W
98	98	Rf 93	Rg 106	step 1	350	27,6	1240	9,7	128
xm007	les19 ●	Ta25 °C		vita media · average life		70000 h		L80 B10	



propulsore dinamico 55/350									
<b>Vb9.580.50.27</b>	argento hacca	2700K	les19 ●	n55	0,2kg 0.4lb				
<b>Vb9.580.51.27</b>	nero55	2700K	les19 ●	n55	0,2kg 0.4lb				
<b>Vb9.580.52.27</b>	my bianco	2700K	les19 ●	n55	0,2kg 0.4lb				

Ra	R9	ies tm-30		sdcm	mA	V <sub>f(min)</sub>	lm	W	lm/W
98	98	Rf 96	Rg 103	step 1	350	27,6	1240	9,7	128
xm000	les19 ●	Ta25 °C		vita media · average life		70000 h		L80 B10	

<b>Vb9.580.50.30</b>	argento hacca	3000K	les19 ●	n55	0,2kg 0.4lb				
<b>Vb9.580.51.30</b>	nero55	3000K	les19 ●	n55	0,2kg 0.4lb				
<b>Vb9.580.52.30</b>	my bianco	3000K	les19 ●	n55	0,2kg 0.4lb				

Ra	R9	ies tm-30		sdcm	mA	V <sub>f(min)</sub>	lm	W	lm/W
98	98	Rf 96	Rg 103	step 1	350	27,6	1240	9,7	128
xm001	les19 ●	Ta25 °C		vita media · average life		70000 h		L80 B10	

<b>Vb9.580.50.30v</b>	argento hacca	3000VbK	les19 ●	n55	0,2kg 0.4lb				
<b>Vb9.580.51.30v</b>	nero55	3000VbK	les19 ●	n55	0,2kg 0.4lb				
<b>Vb9.580.52.30v</b>	my bianco	3000VbK	les19 ●	n55	0,2kg 0.4lb				

Ra	R9	ies tm-30		sdcm	mA	V <sub>f(min)</sub>	lm	W	lm/W
98	98	Rf 93	Rg 106	step 1	350	27,6	1240	9,7	128
xm007	les19 ●	Ta25 °C		vita media · average life		70000 h		L80 B10	



propulsore dinamico 55/500									
<b>Vb9.580.62.27</b>	argento hacca	2700K	les19 ●	n55	0,2kg 0.4lb				
<b>Vb9.580.63.27</b>	nero55	2700K	les19 ●	n55	0,2kg 0.4lb				
<b>Vb9.580.64.27</b>	my bianco	2700K	les19 ●	n55	0,2kg 0.4lb				

Ra	R9	ies tm-30		sdcm	mA	V <sub>f(min)</sub>	lm	W	lm/W
98	98	Rf 96	Rg 103	step 1	500	27,9	1580	14,0	113
xm000	les19 ●	Ta25 °C		vita media · average life		70000 h		L80 B10	

<b>Vb9.580.62.30</b>	argento hacca	3000K	les19 ●	n55	0,2kg 0.4lb				
<b>Vb9.580.63.30</b>	nero55	3000K	les19 ●	n55	0,2kg 0.4lb				
<b>Vb9.580.64.30</b>	my bianco	3000K	les19 ●	n55	0,2kg 0.4lb				

Ra	R9	ies tm-30		sdcm	mA	V <sub>f(min)</sub>	lm	W	lm/W
98	98	Rf 96	Rg 103	step 1	500	27,9	1580	14,0	113
xm001	les19 ●	Ta25 °C		vita media · average life		70000 h		L80 B10	

<b>Vb9.580.62.30v</b>	argento hacca	3000VbK	les19 ●	n55	0,2kg 0.4lb				
<b>Vb9.580.63.30v</b>	nero55	3000VbK	les19 ●	n55	0,2kg 0.4lb				
<b>Vb9.580.64.30v</b>	my bianco	3000VbK	les19 ●	n55	0,2kg 0.4lb				

Ra	R9	ies tm-30		sdcm	mA	V <sub>f(min)</sub>	lm	W	lm/W
98	98	Rf 93	Rg 106	step 1	500	27,9	1580	14,0	113
xm007	les19 ●	Ta25 °C		vita media · average life		70000 h		L80 B10	

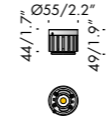

propulsore dinamico 55/500									
<b>Vb9.580.101.27</b>	argento hacca	2700K	les9 ●	n55	0,2kg 0.4lb				
<b>Vb9.580.102.27</b>	nero55	2700K	les9 ●	n55	0,2kg 0.4lb				
<b>Vb9.580.103.27</b>	my bianco	2700K	les9 ●	n55	0,2kg 0.4lb				

Ra	R9	ies tm-30		sdcm	mA	V <sub>f(min)</sub>	lm	W	lm/W
98	98	Rf 96	Rg 103	step 1	500	27,1	800	13,6	59
xe000	les9 ●	Ta25 °C		vita media · average life		70000 h		L80 B10	

<b>Vb9.580.101.30</b>	argento hacca	3000K	les9 ●	n55	0,2kg 0.4lb				
<b>Vb9.580.102.30</b>	nero55	3000K	les9 ●	n55	0,2kg 0.4lb				
<b>Vb9.580.103.30</b>	my bianco	3000K	les9 ●	n55	0,2kg 0.4lb				

Ra	R9	ies tm-30		sdcm	mA	V <sub>f(min)</sub>	lm	W	lm/W
98	98	Rf 96	Rg 103	step 1	500	27,1	800	13,6	59
xe001	les9 ●	Ta25 °C		vita media · average life		70000 h		L80 B10	

<b>Vb9.580.101.30v</b>	argento hacca	3000VbK	les9 ●	n55	0,2kg 0.4lb				
<b>Vb9.580.102.30v</b>	nero55	3000VbK	les9 ●	n55	0,2kg 0.4lb				
<b>Vb9.580.103.30v</b>	my bianco	3000VbK	les9 ●	n55	0,2kg 0.4lb				

Ra	R9	ies tm-30		sdcm	mA	V <sub>f(min)</sub>	lm	W	lm/W
98	98	Rf 93	Rg 106	step 1	500	27,1	800	13,6	59
xe007	les9 ●	Ta25 °C		vita media · average life		70000 h		L80 B10	



propulsore dinamico 65/500e									
<b>Vb9.580.154.27</b>	argento hacca	2700K	les19 ●	n55	0,3kg 0.7lb				
<b>Vb9.580.155.27</b>	nero55	2700K	les19 ●	n55	0,3kg 0.7lb				
<b>Vb9.580.156.27</b>	my bianco	2700K	les19 ●	n55	0,3kg 0.7lb				

Ra	R9	ies tm-30		sdcm	mA	V <sub>f (min)</sub>	lm	W	lm/W
98	98	Rf 96	Rg 103	step 1	500	27,9	1580	14,0	113
xm000	les19 ●	Ta25 °C		vita media · average life		70000 h	L80	B10	

<b>Vb9.580.154.30</b>	argento hacca	3000K	les19 ●	n55	0,3kg 0.7lb				
<b>Vb9.580.155.30</b>	nero55	3000K	les19 ●	n55	0,3kg 0.7lb				
<b>Vb9.580.156.30</b>	my bianco	3000K	les19 ●	n55	0,3kg 0.7lb				

Ra	R9	ies tm-30		sdcm	mA	V <sub>f (min)</sub>	lm	W	lm/W
98	98	Rf 96	Rg 103	step 1	500	27,9	1580	14,0	113
xm001	les19 ●	Ta25 °C		vita media · average life		70000 h	L80	B10	

<b>Vb9.580.154.30v</b>	argento hacca	3000VbK	les19 ●	n55	0,3kg 0.7lb				
<b>Vb9.580.155.30v</b>	nero55	3000VbK	les19 ●	n55	0,3kg 0.7lb				
<b>Vb9.580.156.30v</b>	my bianco	3000VbK	les19 ●	n55	0,3kg 0.7lb				

Ra	R9	ies tm-30		sdcm	mA	V <sub>f (min)</sub>	lm	W	lm/W
98	98	Rf 93	Rg 106	step 1	500	27,9	1580	14,0	113
xm007	les19 ●	Ta25 °C		vita media · average life		70000 h	L80	B10	

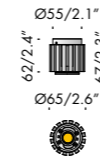

propulsore dinamico 65/700									
<b>Vb9.580.54.27</b>	argento hacca	2700K	les19 ●	n55	0,3kg 0.7lb				
<b>Vb9.580.55.27</b>	nero55	2700K	les19 ●	n55	0,3kg 0.7lb				
<b>Vb9.580.56.27</b>	my bianco	2700K	les19 ●	n55	0,3kg 0.7lb				

Ra	R9	ies tm-30		sdcm	mA	V <sub>f (min)</sub>	lm	W	lm/W
98	98	Rf 96	Rg 103	step 1	700	28,4	2140	19,9	108
xm000	les19 ●	Ta25 °C		vita media · average life		70000 h	L80	B10	

<b>Vb9.580.54.30</b>	argento hacca	3000K	les19 ●	n55	0,3kg 0.7lb				
<b>Vb9.580.55.30</b>	nero55	3000K	les19 ●	n55	0,3kg 0.7lb				
<b>Vb9.580.56.30</b>	my bianco	3000K	les19 ●	n55	0,3kg 0.7lb				

Ra	R9	ies tm-30		sdcm	mA	V <sub>f (min)</sub>	lm	W	lm/W
98	98	Rf 96	Rg 103	step 1	700	28,4	2140	19,9	108
xm001	les19 ●	Ta25 °C		vita media · average life		70000 h	L80	B10	

<b>Vb9.580.54.30v</b>	argento hacca	3000VbK	les19 ●	n55	0,3kg 0.7lb				
<b>Vb9.580.55.30v</b>	nero55	3000VbK	les19 ●	n55	0,3kg 0.7lb				
<b>Vb9.580.56.30v</b>	my bianco	3000VbK	les19 ●	n55	0,3kg 0.7lb				

Ra	R9	ies tm-30		sdcm	mA	V <sub>f (min)</sub>	lm	W	lm/W
98	98	Rf 93	Rg 106	step 1	700	28,4	2140	19,9	108
xm007	les19 ●	Ta25 °C		vita media · average life		70000 h	L80	B10	



propulsore dinamico 65/700									
<b>Vb9.580.106.27</b>	argento hacca	2700K	les9 ●	n55	0,3kg 0.7lb				
<b>Vb9.580.107.27</b>	nero55	2700K	les9 ●	n55	0,3kg 0.7lb				
<b>Vb9.580.108.27</b>	my bianco	2700K	les9 ●	n55	0,3kg 0.7lb				

Ra	R9	ies tm-30		sdcm	mA	V <sub>f</sub> (min)	lm	W	lm/W
98	98	Rf 96	Rg 103	step 1	700	27,9	1110	19,5	57
xe000	les9 ●	Ta25 °C		vita media · average life		70000 h		L80 B10	

<b>Vb9.580.106.30</b>	argento hacca	3000K	les9 ●	n55	0,3kg 0.7lb				
<b>Vb9.580.107.30</b>	nero55	3000K	les9 ●	n55	0,3kg 0.7lb				
<b>Vb9.580.108.30</b>	my bianco	3000K	les9 ●	n55	0,3kg 0.7lb				

Ra	R9	ies tm-30		sdcm	mA	V <sub>f</sub> (min)	lm	W	lm/W
98	98	Rf 96	Rg 103	step 1	700	27,9	1110	19,5	57
xe001	les9 ●	Ta25 °C		vita media · average life		70000 h		L80 B10	

<b>Vb9.580.106.30v</b>	argento hacca	3000VbK	les9 ●	n55	0,3kg 0.7lb				
<b>Vb9.580.107.30v</b>	nero55	3000VbK	les9 ●	n55	0,3kg 0.7lb				
<b>Vb9.580.108.30v</b>	my bianco	3000VbK	les9 ●	n55	0,3kg 0.7lb				

Ra	R9	ies tm-30		sdcm	mA	V <sub>f</sub> (min)	lm	W	lm/W
98	98	Rf 93	Rg 106	step 1	700	27,9	1110	19,5	57
xe007	les9 ●	Ta25 °C		vita media · average life		70000 h		L80 B10	



propulsore dinamico 82/1050									
<b>Vb9.580.58.27</b>	argento hacca	2700K	les19 ●	n55	0,5kg 1.1lb				
<b>Vb9.580.59.27</b>	nero55	2700K	les19 ●	n55	0,5kg 1.1lb				
<b>Vb9.580.60.27</b>	my bianco	2700K	les19 ●	n55	0,5kg 1.1lb				

Ra	R9	ies tm-30		sdcm	mA	V <sub>f</sub> (min)	lm	W	lm/W
98	98	Rf 96	Rg 103	step 1	1050	29,0	3000	30,5	98
xm000	les19 ●	Ta25 °C		vita media · average life		70000 h		L80 B10	



<b>Vb9.580.58.30</b>	argento hacca	3000K	les19 ●	n55	0,5kg 1.1lb				
<b>Vb9.580.59.30</b>	nero55	3000K	les19 ●	n55	0,5kg 1.1lb				
<b>Vb9.580.60.30</b>	my bianco	3000K	les19 ●	n55	0,5kg 1.1lb				

Ra	R9	ies tm-30		sdcm	mA	V <sub>f</sub> (min)	lm	W	lm/W
98	98	Rf 96	Rg 103	step 1	1050	29,0	3000	30,5	98
xm001	les19 ●	Ta25 °C		vita media · average life		70000 h		L80 B10	

<b>Vb9.580.58.30v</b>	argento hacca	3000VbK	les19 ●	n55	0,5kg 1.1lb				
<b>Vb9.580.59.30v</b>	nero55	3000VbK	les19 ●	n55	0,5kg 1.1lb				
<b>Vb9.580.60.30v</b>	my bianco	3000VbK	les19 ●	n55	0,5kg 1.1lb				

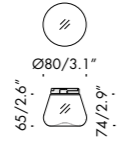
Ra	R9	ies tm-30		sdcm	mA	V <sub>f</sub> (min)	lm	W	lm/W
98	98	Rf 93	Rg 106	step 1	1050	29,0	3000	30,5	98
xm007	les19 ●	Ta25 °C		vita media · average life		70000 h		L80 B10	



**marionanni**  

**Vb9.580.01.t** hm01 trasparente · transparent n55 0,5kg  
1.1lb

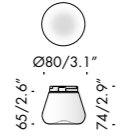

**Vb9.580.01.s** hm01 sabbiata · sanded n55 0,5kg  
1.1lb

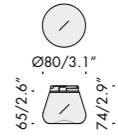

**Vb9.580.01.b** hm01 bianco latte · milk white n55 0,5kg  
1.1lb

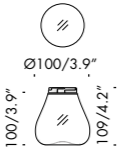

**Vb9.580.02.t** hm02 trasparente · transparent n55 0,1kg  
0.2lb

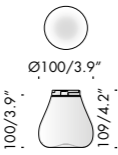

**Vb9.580.02.s** hm02 sabbiata · sanded n55 0,1kg  
0.2lb

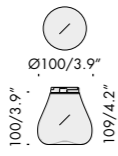

**Vb9.580.02.b** hm02 bianco latte · milk white n55 0,1kg  
0.2lb

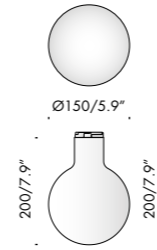

**Vb9.580.03.s** mn01 sabbiato · sanded n55 0,3kg  
0.7lb

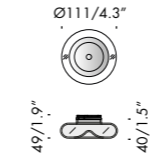

**Vb9.580.173.b** mn06 tabacchiera  
bianco satinato · white frosted n55 0,1kg  
0.2lb

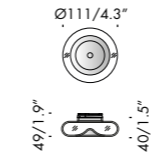

**Vb9.580.173.cr** mn06 tabacchiera  
trasparente cromata · transparent chromed n55 0,1kg  
0.2lb

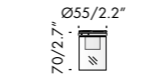

**Vb9.580.178** mn07 trasparente sabbiato · transparent sanded n55 0,1kg  
0.2lb



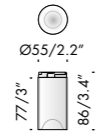

<b>david chipperfield</b>			
<b>Vb9.580.05.s</b>	dc01 sabbaiato · sanded	n55	0,1kg 0.2lb

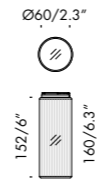

<b>al-jawad pike</b>			
<b>Vb9.580.18.tr</b>	ajp01 trasparente, rigato transparent, striped	n55	0,2kg 0.4lb

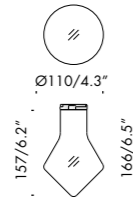

<b>peter zumthor</b>			
<b>Vb9.580.11.t</b>	pz03 trasparente · transparent	n55	0,2kg 0.4lb

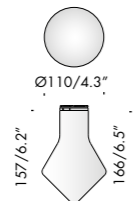

<b>Vb9.580.11.s</b>	pz03 sabbaiato · sanded	n55	0,2kg 0.4lb
---------------------	-------------------------	-----	----------------

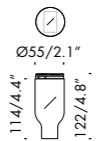
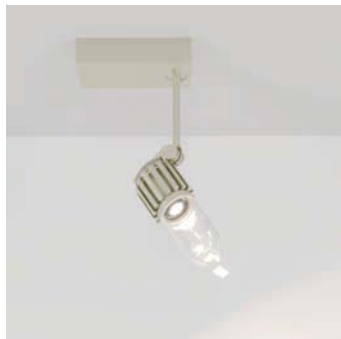

<b>kengo kuma</b>			
<b>Vb9.580.07.c</b>	kk01 cristallo · crystal	n55	0,3kg 0.7lb



<b>accessori per lampadina trasparente. transparent bulb accessories.</b>			
<b>Vb9.580.160</b>	trappola di luce antiabbagliamento nero anti-glare black light trap		0,03kg 0.07lb

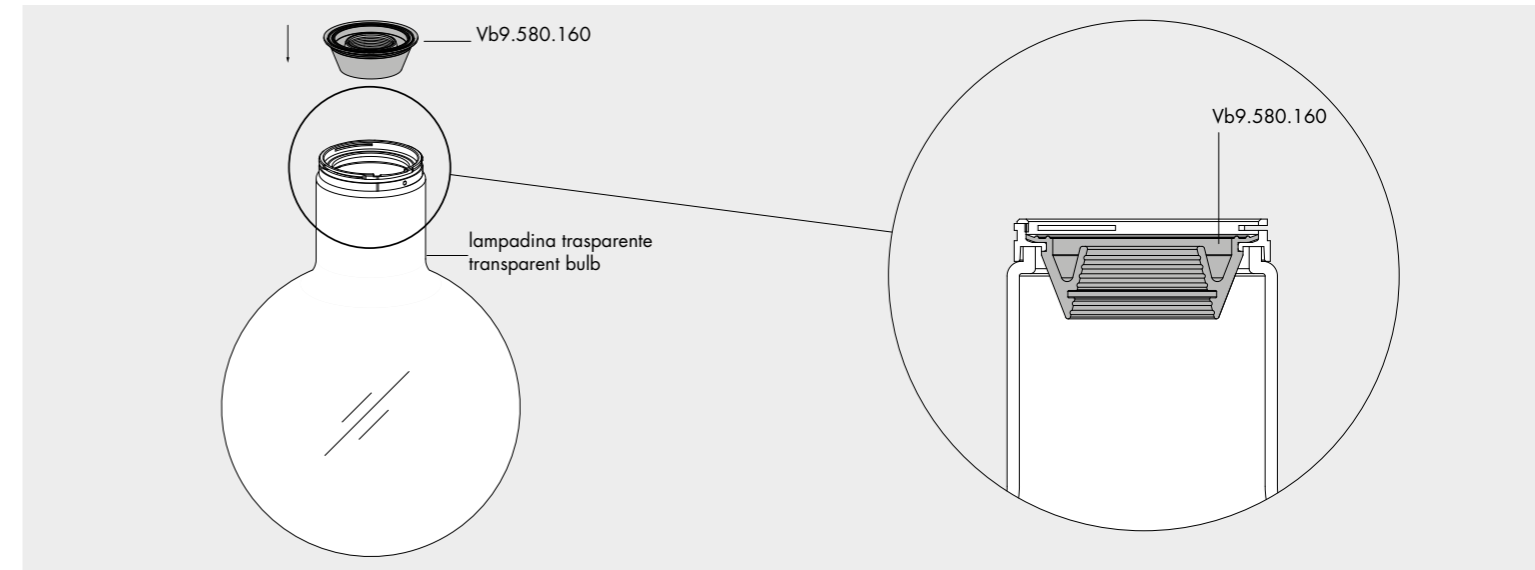

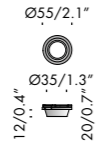

spot35					
<b>Vb9.580.21</b>	argento hacca	87° les19	n55	0,1kg 0.2lb	
<b>Vb9.580.22</b>	nero55	87° les19	n55	0,1kg 0.2lb	
<b>Vb9.580.22.b</b>	my bianco	87° les19	n55	0,1kg 0.2lb	



spot55x37					
<b>Vb9.580.121</b>	argento hacca	18° les9	n55	0,1kg 0.2lb	
<b>Vb9.580.122</b>	nero55	18° les9	n55	0,1kg 0.2lb	
<b>Vb9.580.122.b</b>	my bianco	18° les9	n55	0,1kg 0.2lb	
<b>Vb9.580.123</b>	argento hacca	23° les9 ● 30° les19 ●	n55	0,1kg 0.2lb	
<b>Vb9.580.124</b>	nero55	23° les9 ● 30° les19 ●	n55	0,1kg 0.2lb	
<b>Vb9.580.124.b</b>	my bianco	23° les9 ● 30° les19 ●	n55	0,1kg 0.2lb	
<b>Vb9.580.125</b>	argento hacca	36° les9 ● 38° les19 ●	n55	0,1kg 0.2lb	
<b>Vb9.580.126</b>	nero55	36° les9 ● 38° les19 ●	n55	0,1kg 0.2lb	
<b>Vb9.580.126.b</b>	my bianco	36° les9 ● 38° les19 ●	n55	0,1kg 0.2lb	

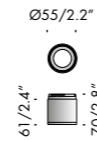

spot55x61					
<b>Vb9.580.25</b>	argento hacca	36° les19 ●	n55	0,2kg 0.4lb	
<b>Vb9.580.26</b>	nero55	36° les19 ●	n55	0,2kg 0.4lb	
<b>Vb9.580.26.b</b>	my bianco	36° les19 ●	n55	0,2kg 0.4lb	
<b>Vb9.580.27</b>	argento hacca	47° les19 ●	n55	0,2kg 0.4lb	
<b>Vb9.580.28</b>	nero55	47° les19 ●	n55	0,2kg 0.4lb	
<b>Vb9.580.28.b</b>	my bianco	47° les19 ●	n55	0,2kg 0.4lb	

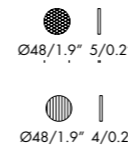

accessori spot55. accessories.				
<b>Vb9.580.91</b>	frangiluce nido d'ape · honeycomb louvre			0,01kg 0.02lb
<b>Vb9.580.92</b>	lente ellittica · elliptical lens			0,04kg 0.09lb



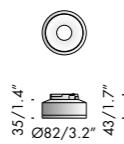

spot82x35				Ⓜ	i
<b>Vb9.580.131</b>	argento hacca	13° les9 ●	n55	0,1kg 0.2lb	
<b>Vb9.580.132</b>	nero55	13° les9 ●	n55	0,1kg 0.2lb	
<b>Vb9.580.137</b>	my bianco	13° les9 ●	n55	0,1kg 0.2lb	
<b>Vb9.580.133</b>	argento hacca	19° les9 ●	n55	0,1kg 0.2lb	
<b>Vb9.580.134</b>	nero55	19° les9 ●	n55	0,1kg 0.2lb	
<b>Vb9.580.138</b>	my bianco	19° les9 ●	n55	0,1kg 0.2lb	
<b>Vb9.580.135</b>	argento hacca	23° les9 ● 31° les19 ●	n55	0,1kg 0.2lb	
<b>Vb9.580.136</b>	nero55	23° les9 ● 31° les19 ●	n55	0,1kg 0.2lb	
<b>Vb9.580.141</b>	my bianco	23° les9 ● 31° les19 ●	n55	0,1kg 0.2lb	
<b>Vb9.580.139</b>	argento hacca	35° les9 ● 42° les19 ●	n55	0,1kg 0.2lb	
<b>Vb9.580.140</b>	nero55	35° les9 ● 42° les19 ●	n55	0,1kg 0.2lb	
<b>Vb9.580.142</b>	my bianco	35° les9 ● 42° les19 ●	n55	0,1kg 0.2lb	

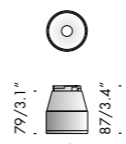

spot82x79				Ⓜ	i
<b>Vb9.580.31</b>	argento hacca	23° les19 ●	n55	0,2kg 0.4lb	
<b>Vb9.580.32</b>	nero55	23° les19 ●	n55	0,2kg 0.4lb	
<b>Vb9.580.32.b</b>	my bianco	23° les19 ●	n55	0,2kg 0.4lb	
<b>Vb9.580.33</b>	argento hacca	37° les19 ●	n55	0,2kg 0.4lb	
<b>Vb9.580.34</b>	nero55	37° les19 ●	n55	0,2kg 0.4lb	
<b>Vb9.580.34.b</b>	my bianco	37° les19 ●	n55	0,2kg 0.4lb	
<b>Vb9.580.35</b>	argento hacca	46° les19 ●	n55	0,2kg 0.4lb	
<b>Vb9.580.36</b>	nero55	46° les19 ●	n55	0,2kg 0.4lb	
<b>Vb9.580.36.b</b>	my bianco	46° les19 ●	n55	0,2kg 0.4lb	

**accessori spot82. accessories.** Ⓜ i



<b>Vb9.580.86</b>	frangiluce nido d'ape · honeycomb louvre	0,01kg 0.02lb
-------------------	--	------------------



<b>Vb9.580.87</b>	lente ellittica · elliptical lens	0,05kg 0.11lb
-------------------	-----------------------------------	------------------

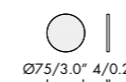

<b>Vb9.580.88</b>	vetro albarino · albarino glass	0,05kg 0.11lb
-------------------	---------------------------------	------------------



<b>Vb9.580.165</b>	anti abbagliamento · anti-glare	0,03kg 0.07lb
--------------------	---------------------------------	------------------

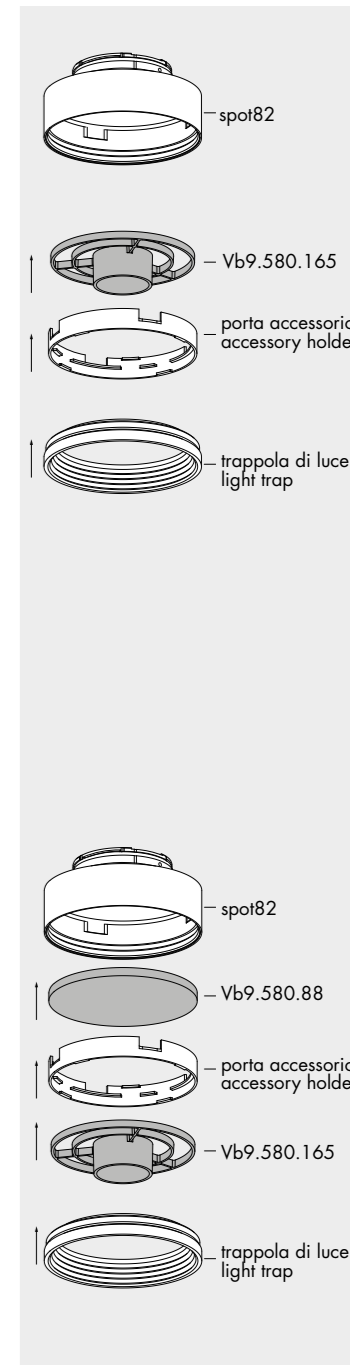



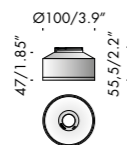

spot100					
<b>Vb9.580.37</b>	argento hacca	10° les9 ●	16° les19 ●	n55	0,1kg 0.2lb
<b>Vb9.580.38</b>	nero55	10° les9 ●	16° les19 ●	n55	0,1kg 0.2lb
<b>Vb9.580.38.b</b>	my bianco	10° les9 ●	16° les19 ●	n55	0,1kg 0.2lb
<b>Vb9.580.39</b>	argento hacca	22° les9 ●	25° les19 ●	n55	0,1kg 0.2lb
<b>Vb9.580.40</b>	nero55	22° les9 ●	25° les19 ●	n55	0,1kg 0.2lb
<b>Vb9.580.40.b</b>	my bianco	22° les9 ●	25° les19 ●	n55	0,1kg 0.2lb
<b>Vb9.580.41</b>	argento hacca		40° les19 ●	n55	0,1kg 0.2lb
<b>Vb9.580.42</b>	nero55		40° les19 ●	n55	0,1kg 0.2lb
<b>Vb9.580.42.b</b>	my bianco		40° les19 ●	n55	0,1kg 0.2lb
<b>Vb9.580.43</b>	argento hacca		54° les19 ●	n55	0,1kg 0.2lb
<b>Vb9.580.44</b>	nero55		54° les19 ●	n55	0,1kg 0.2lb
<b>Vb9.580.44.b</b>	my bianco		54° les19 ●	n55	0,1kg 0.2lb

accessori spot100. accessories.					
<b>Vb9.580.93</b>	frangiluce nido d'ape · honeycomb louvre				0,1kg 0.2lb
<b>Vb9.580.94</b>	lente ellittica · elliptical lens				0,05kg 0.11lb

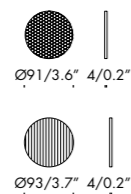

dimensioni gobos in acciaio  
steel gobos size

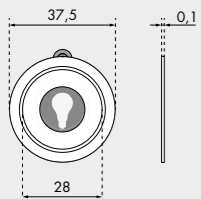

dimensioni gobos in vetro  
glass gobos size

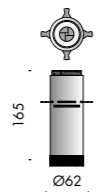
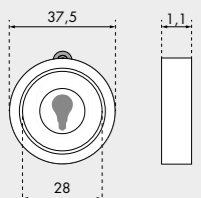

**spot sagomatore**

**Vb9.580.120** sagomatore · profile spot les19 ● n55 0,7kg 1.5lb

**accessori. accessories.**

- Vb9.580.118** gruppo per alloggiamento gobo in vetro housing for glass gobos 0,01kg 0.02lb
- Vb9.580.119** gruppo per alloggiamento gobo in acciaio housing for steel gobos 0,1kg 0.2lb

utilizzabile solo con · use only with propulsore dinamico les19 ●

propulsore dinamico 82/1050

22°

d(m)=

1 2 3 4 5 6

d (m)	ab (m)	e <sub>max</sub> (lx)	e <sub>med</sub> (lx)
1	0,38	2761	2273
2	0,76	690	568
3	1,14	307	253
4	1,51	173	142
5	1,89	110	91
6	2,27	77	63

montaggio su propulsore dinamico n55  
propeller mounting

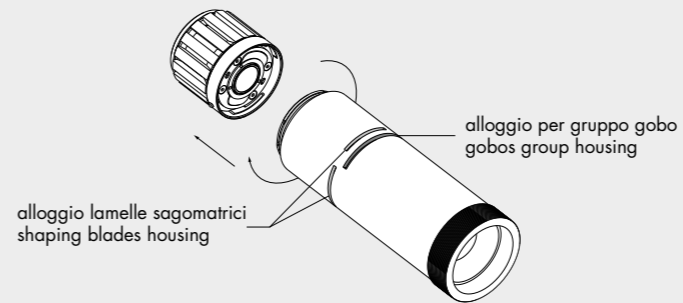

messa a fuoco · focus

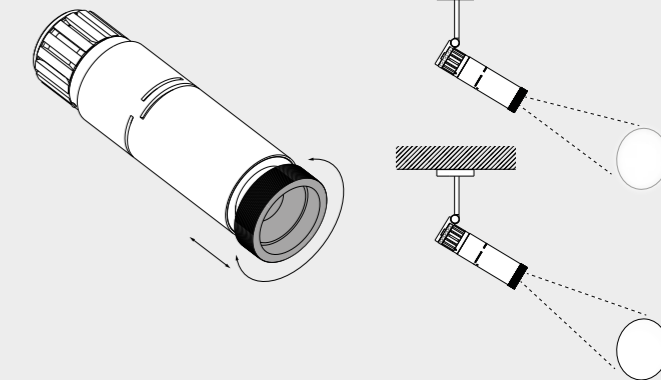

uso delle lamelle sagomatrici · use of shaping blades

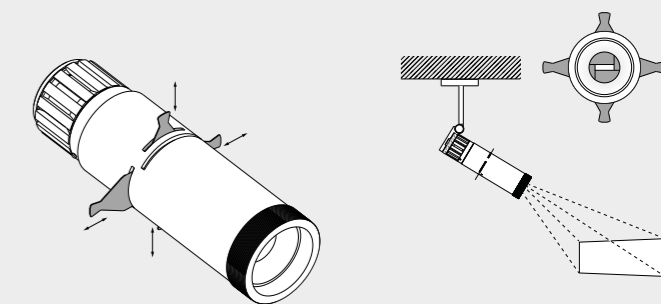
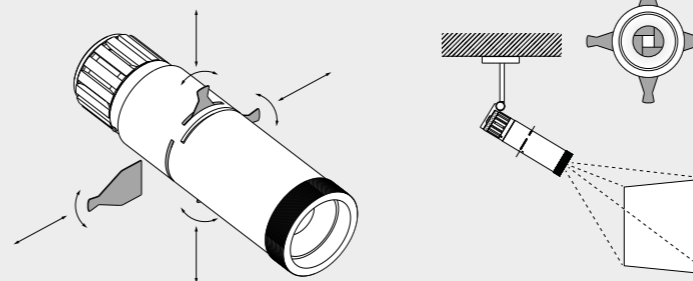

gobo in vetro non incluso  
glass gobos not included

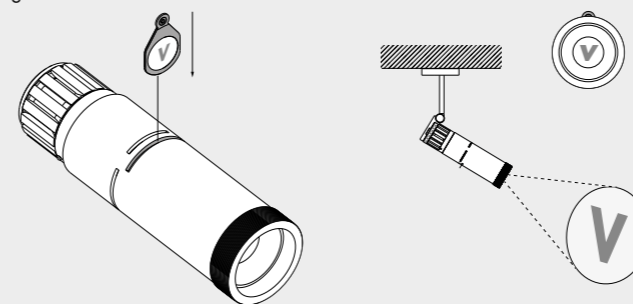

gobo in acciaio non incluso  
steel gobos not included

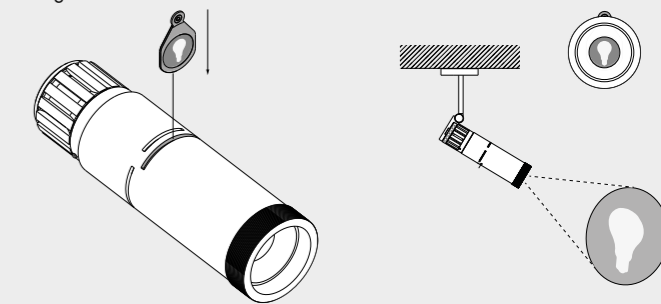

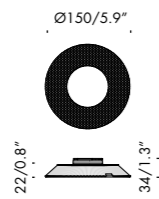

lensoptica amP150						
<b>Vb9.518.91</b>	fascio stretto narrow beam	13° 22°	les9 ● les19 ●	n55	0,3kg 0,7lb	
<b>Vb9.518.92</b>	fascio largo wide beam	51°	les19 ●	n55	0,3kg 0,7lb	

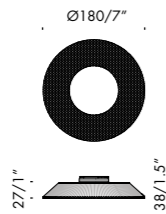

lensoptica amP180						
<b>Vb9.518.81</b>	fascio stretto narrow beam	10° 15°	les9 ● les19 ●	n55	0,6kg 1.3lb	
<b>Vb9.518.82</b>	fascio medio medium beam	41°	les19 ●	n55	0,6kg 1.3lb	
<b>Vb9.518.83</b>	fascio largo wide beam	53°	les19 ●	n55	0,6kg 1.3lb	
<b>Vb9.518.84</b>	fascio ellittico elliptical beam	20°x55°	les19 ●	n55	0,6kg 1.3lb	

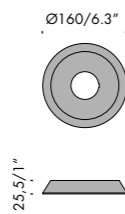

riflettore in metallo 150			
<b>Vb9.518.95.n</b>	nero55		0,1kg 0.2lb
<b>Vb9.518.95.mb</b>	my bianco		0,1kg 0.2lb
<b>Vb9.518.95.h</b>	argento hacca		0,1kg 0.2lb

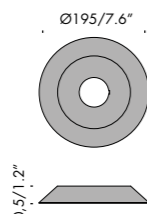

riflettore in metallo 180			
<b>Vb9.518.96.n</b>	nero55		0,1kg 0.2lb
<b>Vb9.518.96.mb</b>	my bianco		0,1kg 0.2lb
<b>Vb9.518.96.h</b>	argento hacca		0,1kg 0.2lb



propulsore dinamico n55

riflettore in metallo · metal reflector

lensoptica amP

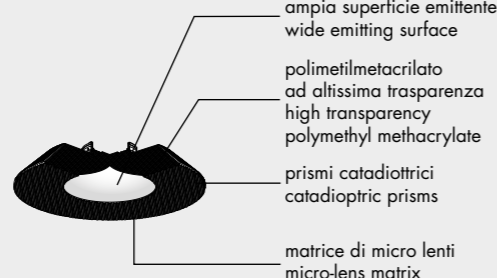
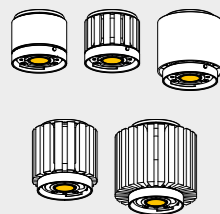

ampia superficie emittente  
wide emitting surface

polimetilmetacrilato  
ad altissima trasparenza  
high transparency  
polymethyl methacrylate

prismi catadiottrici  
catadioptric prisms

matrice di micro lenti  
micro-lens matrix

materiale	coefficiente d'assorbimento $\alpha$
vetro soda calcico	0,017 mm <sup>-1</sup>
poli-carbonato	0,004 mm <sup>-1</sup>
polimetilmetacrilato	0,0014 mm <sup>-1</sup>

la trasmittanza interna (T) di un materiale trasparente è determinata dallo spessore (x) e dal coefficiente d'assorbimento del materiale stesso ( $\alpha$ ) secondo la legge di lambert-beer  $T_{(x)} = e^{-\alpha x}$   
the internal transmittance of a transparent material (T) is determined by the thickness (x) and by the absorbing coefficient of the material itself ( $\alpha$ ) due to lambert-beer law  $T_{(x)} = e^{-\alpha x}$

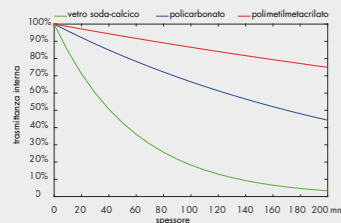

**lensoptica amP** è allo stesso tempo una lente e un riflettore, perché i raggi di luce subiscono rifrazione e riflessione totale interna. per questa caratteristica tecnica riesce a coniugare alta efficienza e accurato controllo direzionale della luce.  
**lensoptica amP** is both a lens and a reflector at the same time, because the rays of light undergo refraction and total internal reflection. for this technical characteristic it combines high efficiency and accurate directional control of light.

la superficie emittente di **lensoptica amP** è dotata di una matrice di microlenti. ogni microlente riceve un fascio collimato e in funzione della curvatura ne allarga l'apertura angolare in modo controllato. la sovrapposizione dei contributi delle singole microlenti produce una distribuzione d'illuminamento uniforme.

le **lensoptica amP** si suddividono in quattro categorie di apertura angolare del fascio: stretto, medio, largo ed ellittico. il valore esatto dell'angolo dipende dal diametro della sorgente.

**lensoptica amP** emitter surface is equipped with a microlens array. each microlens receives a collimated beam and according to its curvature it enlarges the angular opening in a controlled way.

the overlap of the emissions of each microlens creates a uniform distribution of illumination.

**lensoptica amP** are divided into four categories based on the angular opening of the beam: narrow, medium, wide and elliptical. the exact value of the angle depends on the source diameter.

**lensoptica amP** è il risultato di una ricerca sviluppata da Viabizzuno su progetto david chipperfield architects con lo studio internazionale di ingegneria arup per fornire alle sorgenti luminose elettroniche un'ottica ad alta efficienza in grado di avere sia una luce concentrata che diffusa. l'alta efficienza viene ottenuta utilizzando un materiale ad altissima trasparenza, il polimetilmetacrilato, per mezzo di prismi catadiottrici progettati per riflettere e trasmettere la luce minimizzando le perdite per assorbimento: tali elementi riflettono verso il basso il 90% del flusso luminoso incidente e ne trasmettono il 10% garantendo così una percentuale di emissione indiretta, non ottenibile con il riflettore in metallo.

la matrice di microlenti regola in modo preciso l'ampiezza angolare del fascio luminoso.

l'ampia superficie emittente garantisce un alto comfort visivo e UGR<19.

**lensoptica amP** is the result of a long research and development process made by Viabizzuno on a david chipperfield architects with arup, international engineering studio, design to provide electronic light sources with a high efficiency optics that can have either a focused and a diffuse light.

high efficiency is achieved thanks to a very high transparent material, i.e. polymethyl methacrylate, by means of catadioptric prisms specifically designed to reflect and transmit light reducing losses due to absorption: these elements, reflect 90% of the incident light flow downwards and transmit 10% of it, assuring this way a percentage of indirect emission which could not be reached with metal reflector.

the microlens array precisely regulates the angular amplitude of the light beam.

the large emitter surface limits luminance, ensuring high visual comfort and UGR<19.

**lensoptica amP150**  
13° les9

fascio stretto · narrow beam

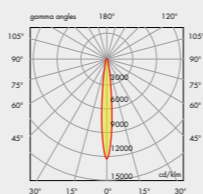

**lensoptica amP150 22°**  
les19

fascio stretto · narrow beam

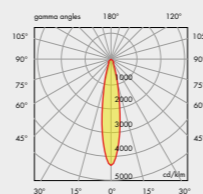

**lensoptica amP150 51°**  
les19

fascio largo · wide beam

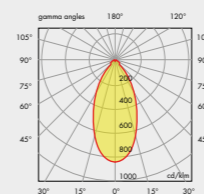

**lensoptica amP180 10°**  
les9

fascio stretto · narrow beam

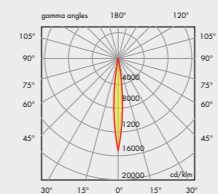

**lensoptica amP180 15°**  
les19

fascio stretto · narrow beam

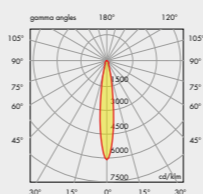

**lensoptica amP180 41°**  
les19

fascio medio · medium beam

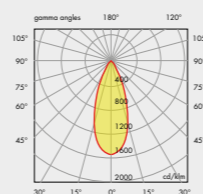

**lensoptica amP180 53°**  
les19

fascio largo · wide beam

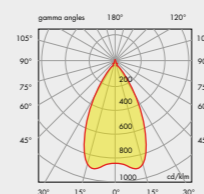

**lensoptica amP180 20°x55°**  
les19

fascio ellittico · elliptical beam

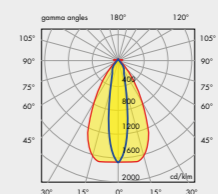

**lensoptica amP150**  
fascio stretto · narrow beam



**lensoptica amP180**  
fascio stretto · narrow beam



**lensoptica amP180**  
fascio medio · medium beam



**lensoptica amP150**  
fascio largo · wide beam

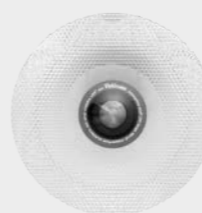

**lensoptica amP180**  
fascio largo · wide beam



**lensoptica amP180**  
fascio ellittico · elliptical beam



**lensoptica amP**  
installazione · mounting

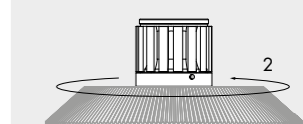
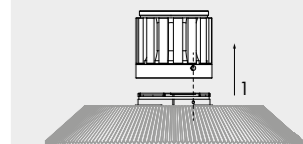
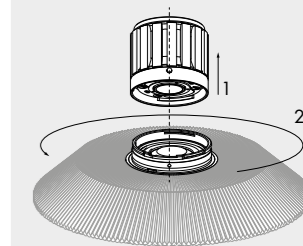
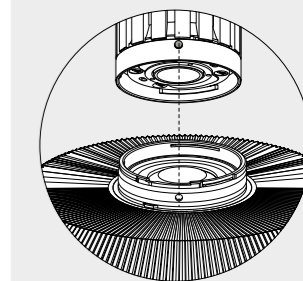

## n55® parete soffitto orientabile marionanni 2014



brevettato · patented

apparecchio di illuminazione a parete o soffitto per interni realizzato in alluminio ossidato.

modelli:

**n55 parete soffitto orientabile con alimentatore 120V 50-60Hz integrato 60x155mm/2.4x6.1"**

**h.133mm/5.2"**,

**n55 parete soffitto orientabile con alimentatore escluso, diametro Ø80mm/3.1" con tige**

**h.100mm/3.9"**,

**n55 parete soffitto scomparsa totale orientabile con alimentatore escluso, con tige**

**h.100mm/3.9"**.

**in tutte le versioni la tige è di diametro Ø10mm/0.5" con interfaccia orientabile di diametro Ø55mm/2.1"**.

**da abbinare ai seguenti propulsori dinamici n55:**

**55/350e les19 fino a 9,7W 350mA 1240lm,**

**55/350 les19 fino a 9,7W 350mA 1240lm,**

**55/500 les19 fino a 14W 500mA 1580lm,**

**55/500 les9 fino a 13,6W 500mA 800lm,**

**65/500e les19 fino a 14W 500mA 1580lm,**

**65/700 les19 fino a 19,9W 700mA 2140lm,**

**65/700 les9 fino a 19,5W 700mA 1110lm,**

**82/1050 les19 fino a 30,5W 1050mA 3000lm.**

**tutti i propulsori sono Ra98 1 step macadam con sorgente elettronica 2700K, 3000K o 3000Vb K (progettato per il settore alta moda).**

**l'apposito attacco n55 permette di intercambiare tre tipi di lampadina: classica, decorativa e tecnica. eventuali irregolarità del vetro sono garanzia di un prodotto unico, soffiato e realizzato interamente a mano da maestri vetrai.**

**la versione con alimentatore integrato è fornita di controllo intelligente che regola automaticamente la corrente al tipo di propulsore. lo stesso alimentatore può essere ordinato a parte per le altre versioni.**

**finiture: argento hacca, nero55, my bianco.**

**diffusori classici e decorativi con vetro trasparente, sabbiato e bianco latte.**

**personalizza la tua luce vai su [www.Viabizzuno.com](http://www.Viabizzuno.com)**

**damp location rated wall or ceiling light fitting for indoor use made of oxidised aluminium. versions:**

**n55 parete soffitto orientabile with 120V integrated power supply 60x155mm/2.4x6.1"**

**h.133mm/5.2"**,

**n55 parete soffitto orientabile with power supply not included, Ø80mm/3.1" with**

**h.100mm/3.9" rod,**

**n55 parete soffitto scomparsa totale orientabile with power supply not included, with**

**h.100mm/3.9" rod;**

**in all versions the rod has a 10mm diameter with a Ø55mm/2.1" adjustable interface.**

**which can be paired with the following propulsori dinamici n55:**

**55/350e les19 up to 9.7W 350mA 1240lm,**

**55/350 les19 up to 9.7W 350mA 1240lm,**

**55/500 les19 up to 14W 500mA 1580lm,**

**55/500 les9 up to 13.6W 500mA 800lm,**

**65/500e les19 up to 14W 500mA 1580lm,**

**65/700 les19 up to 19.9W 700mA 2140lm,**

**65/700 les9 up to 19.5W 700mA 1110lm,**

**82/1050 les19 up to 30.5W 1050mA 3000lm.**

**all propellers are Ra98 1 step macadam with 2700K, 3000K or 3000Vb K electronic source (designed for high fashion industry).**

**the specific n55 lamp-holder allows to change three types of light bulbs: classic, decorative and technical. any irregularities in the glass are a guarantee of an unique product, blown and entirely hand crafted by master glassmakers.**

**the version with integrated power supply has a special intelligent control which automatically provides the suitable current according to the type of propeller. the same power supply can also be ordered separately for the other versions.**

**finishes: argento hacca, nero55, my bianco.**

**classic and decorative diffuser with transparent, sanded and milk white glass.**

**customize your light visit [www.Viabizzuno.com](http://www.Viabizzuno.com)**



## n55® parete soffitto orientabile marionanni 2014



brevettato · patented

apparecchio di illuminazione a parete o soffitto per interni realizzato in alluminio ossidato.

modelli:

**n55 parete soffitto orientabile con alimentatore 120V 50-60Hz integrato 60x155mm/2.4x6.1"**

**h.133mm/5.2"**,

**n55 parete soffitto orientabile con alimentatore escluso, diametro Ø80mm/3.1" con tige**

**h.100mm/3.9"**,

**n55 parete soffitto scomparsa totale orientabile con alimentatore escluso, con tige**

**h.100mm/3.9"**.

**in tutte le versioni la tige è di diametro Ø10mm/0.5" con interfaccia orientabile di diametro Ø55mm/2.1"**.

**da abbinare ai seguenti propulsori dinamici n55:**

**55/350e les19 fino a 9,7W 350mA 1240lm,**

**55/350 les19 fino a 9,7W 350mA 1240lm,**

**55/500 les19 fino a 14W 500mA 1580lm,**

**55/500 les9 fino a 13,6W 500mA 800lm,**

**65/500e les19 fino a 14W 500mA 1580lm,**

**65/700 les19 fino a 19,9W 700mA 2140lm,**

**65/700 les9 fino a 19,5W 700mA 1110lm,**

**82/1050 les19 fino a 30,5W 1050mA 3000lm.**

**tutti i propulsori sono Ra98 1 step macadam con sorgente elettronica 2700K, 3000K o 3000Vb K (progettato per il settore alta moda).**

**l'apposito attacco n55 permette di intercambiare tre tipi di lampadina: classica, decorativa e tecnica. eventuali irregolarità del vetro sono garanzia di un prodotto unico, soffiato e realizzato interamente a mano da maestri vetrai.**

**la versione con alimentatore integrato è fornita di controllo intelligente che regola automaticamente la corrente al tipo di propulsore. lo stesso alimentatore può essere ordinato a parte per le altre versioni.**

**finiture: argento hacca, nero55, my bianco.**

**diffusori classici e decorativi con vetro trasparente, sabbiato e bianco latte.**

**personalizza la tua luce vai su [www.Viabizzuno.com](http://www.Viabizzuno.com)**

**damp location rated wall or ceiling light fitting for indoor use made of oxidised aluminium. versions:**

**n55 parete soffitto orientabile with 120V integrated power supply 60x155mm/2.4x6.1"**

**h.133mm/5.2"**,

**n55 parete soffitto orientabile with power supply not included, Ø80mm/3.1" with**

**h.100mm/3.9" rod,**

**n55 parete soffitto scomparsa totale orientabile with power supply not included, with**

**h.100mm/3.9" rod;**

**in all versions the rod has a 10mm diameter with a Ø55mm/2.1" adjustable interface.**

**which can be paired with the following propulsori dinamici n55:**

**55/350e les19 up to 9.7W 350mA 1240lm,**

**55/350 les19 up to 9.7W 350mA 1240lm,**

**55/500 les19 up to 14W 500mA 1580lm,**

**55/500 les9 up to 13.6W 500mA 800lm,**

**65/500e les19 up to 14W 500mA 1580lm,**

**65/700 les19 up to 19.9W 700mA 2140lm,**

**65/700 les9 up to 19.5W 700mA 1110lm,**

**82/1050 les19 up to 30.5W 1050mA 3000lm.**

**all propellers are Ra98 1 step macadam with 2700K, 3000K or 3000Vb K electronic source (designed for high fashion industry).**

**the specific n55 lamp-holder allows to change three types of light bulbs: classic, decorative and technical. any irregularities in the glass are a guarantee of an unique product, blown and entirely hand crafted by master glassmakers.**

**the version with integrated power supply has a special intelligent control which automatically provides the suitable current according to the type of propeller. the same power supply can also be ordered separately for the other versions.**

**finishes: argento hacca, nero55, my bianco.**

**classic and decorative diffuser with transparent, sanded and milk white glass.**

**customize your light visit [www.Viabizzuno.com](http://www.Viabizzuno.com)**



## lettura delle tabelle tecniche how to read technical tables

xxxxxxxxxxxxxxxx				120V 50-60Hz	A	wet	UL	UL US	i
a	b	c	d	e	f	f	g		

xxxxxxxxxxxxxxxx				120V 50-60Hz	A	wet	UL	UL US	i
Vbx.xxx.xx	nero55	3000K	35W	20°	0,8kg	1.8lb			
h	i	l	m	n	g				

### componenti. components.

### accessori. accessories.

1	2	3	4	5	6	7	8	9	
Ra	R9	ies tm-30		sdc	mA	V <sub>f (min)</sub>	lm	W	lm/W
98	98	Rf 96	Rg 103	step 1	350	27,6	1240	9,7	128
					500	27,9	1580	14,0	113
xm000	les19	Ta25 °C		vita media · average life		50000 h	L80	B10	
10	11						12	13	

## classificazione ambiente di installazione installation location rating

bandella tecnica. posizioni standard simbologie.  
data plate. standard arrangement of symbols.

a	nome apparecchio di illuminazione · light fitting name
b	tensione di alimentazione · supply rating (Volt)
c	frequenza di alimentazione · supply frequency (Hertz)
d	alimentatore incluso o escluso · power supply included or not included
e	classificazione ambiente di installazione · installation location rating
f	marchio di certificazione · safety and quality standards certification
g	peso netto · net weight (kg/lb)
h	codice · code
i	finiture · colours and finishes
l	temperatura colore sorgente elettronica colour temperature led source (Kelvin)
m	potenza della sorgente · source power (Watt)
n	gradi fascio luminoso · light beam degrees

componenti. identifica tutti gli elementi indispensabili per la corretta funzionalità e installazione dell'apparecchio di illuminazione.  
components. includes all items that are essential to the correct operation and installation of the light fitting.

accessori. si riferisce alle ulteriori parti installabili sull'apparecchio.  
accessories. refers to items that can be added to the light fitting.

1	indice di resa cromatica · colour rendering index
2	indice di resa del rosso · red colour rendering index
3	Rf indice di fedeltà colore · colour fidelity index Rg indice di saturazione colore · color gamut index
4	step di macadam · macadam step
5	corrente di alimentazione · power supply current
6	tensione di alimentazione · power supply voltage
7	flusso luminoso · light flux
8	potenza della sorgente · source power
9	efficienza della sorgente · source efficiency
10	codice sorgente elettronica Viabizzuno · Viabizzuno led source code
11	superficie emittente · light emitting surface (mm)
12	% flusso residuo a fine vita · end life % flux
13	% consentita sotto limite · allowed % under limit

**wet** prodotto classificato per uso esterno · product classified for outdoor use

**damp** prodotto classificato per uso interno in ambienti umidi (bagno, sauna, ecc..) · product classified for indoor use in damp environments (bathrooms, saunas, etc.)

**dry** prodotto classificato per uso interno in ambienti asciutti · product classified for indoor use in dry environments

## legenda simboli symbols legenda

 prodotto in conformità con le direttive nord americane sui soffioni doccia · produced in compliance with showerheads northamerican directives

 componente certificato per il mercato nord americano idoneo ad essere utilizzato e valutato come parte di in un sistema più complesso  
component approved for north american market and suitable to be used and approved as part of a more complex system

 prodotto finito idoneo per essere commercializzato nel mercato nord americano · listed product suitable for the north american market

 prodotto finito idoneo per essere commercializzato nel mercato nord americano · listed product suitable for the north american market

**type ic** apparecchio di illuminazione ad incasso progettato per funzionare a contatto con materiale isolante.  
recessed luminaire designed to work in contact with thermal insulation.

**type non-ic** apparecchio di illuminazione ad incasso progettato per funzionare in intercapedini che abbiano una certa distanza da materiali isolanti.  
recessed luminaire designed to work in cavities that have a minimum dimensions and spacings to thermal insulation.

**title24** prodotto conforme allo standard title24 · product compliant with title24 standard

 vetro opalino · opal glass

 vetro sabbiato · sanded glass

 vetro nero fumè · black smoke glass

 vetro trasparente · transparent glass

 vetro bianco latte · white milk glass

 cristallo · crystal

 policarbonato opalino · opal polycarbonate diffuser

 carrabile · drive over

**A** alimentatore incluso · power supply included

**A** alimentatore escluso · power supply not included

**AR** alimentatore remoto incluso · remote power supply included

**Ai** alimentatore elettronico con controllo intelligente incluso · electronic power supply with smart control included

**AiR** alimentatore elettronico con controllo intelligente incluso, da installare remoto · electronic power supply with smart control included, to be installed remotely

**AS** alimentatore a spina incluso · plug power supply included

**T** trasformatore incluso · transformer included

**K** kit di cablaggio incluso · wiring kit not included

**K** kit di cablaggio escluso · wiring kit not included

**L** lampadina con sorgente elettronica led, ad incandescenza, alogena o fluorescente inclusa.  
bulb with led electronic source, incandescent, halogen or fluorescent included.

**L** lampadina con sorgente elettronica led, ad incandescenza, alogena o fluorescente esclusa.  
bulb with led electronic source, incandescent, halogen or fluorescent not included.

**PR** propulsore dinamico n55 incluso · included

 attenzione: sorgente luminosa led. non guardare mai direttamente a occhio nudo · attention: led light source. never look straight without eye protection

**i** peso netto · net weight (kg)

 possibilità di combinazione tra interfaccia n55, propulsore dinamico n55 e lampadina n55 · possible combination between n55 interface, propulsore dinamico n55 and n55 bulb

**I.d.** luce diretta · direct light

**I.i.** luce indiretta · indirect light

**V**  disponibile su · available on *Viabizzuno applight* [www.Viabizzuno.com](http://www.Viabizzuno.com) *Viabizzuno online*