



Viabizzuno strada principale della frazione di bizzuno in provincia di ravenna dove tra la casa del popolo e la parrocchia, al n°17, sono nato il ventuno luglio millenovecentocinquantacinque. da qui nasce il nome della fabbrica di produzione fondata nel millenovecentonovantaquattro rappresentata da uno spazio bianco attraversato da due linee. una verticale, rigorosa, essenziale, equilibrata: la luce per la luce; ed una inclinata, irriverente nello spazio, ironica, fuori dagli schemi: la luce per la forma. distinte ma complementari si fondono in un unico nome: Viabizzuno.

marionanni

Viabizzuno is the name of the main road of the small village bizzuno located in the province of ravenna, where I was born on the twenty-first july nineteenfiftyfive at n°17, between the 'casa del popolo' and the local parish church. from here the name of the factory founded in nineteen ninety-four represented by a white space intersected by two lines. one vertical, well balanced, logical, essential: the light for the light. the other one dynamic, irreverent, ironic: the light for the form. separate and yet complementary they cast in the same name: Viabizzuno.

prodotto
product



schede tecniche
data sheets



curve fotometriche
photometric curves



modelli 3d per i tuoi render
3d models for your render





apparecchio di illuminazione a soffitto per interni IP20 realizzato in alluminio ossidato. modelli con alimentatore incluso, da installare remoto o con alimentatore integrato:
n55 soffitto con diffusore decorativo aip01,
n55 soffitto con diffusore decorativo dc02,
n55 soffitto con diffusore decorativo mn01,
n55 soffitto con diffusore decorativo pz01,
n55 soffitto con diffusore decorativo pz03,
n55 soffitto con diffusore decorativo wm01.
cablato con propulsore dinamico n55 55/500 les19 14W 500mA 1580lm, Ra98 1 step macadam.

l'apposito attacco n55 permette di intercambiare tre tipi di lampadina: classica, decorativa e tecnica. eventuali irregolarità del vetro sono garanzia di un prodotto unico, soffiato e realizzato interamente a mano da maestri vetrai.

la versione con alimentatore 120-240V 50-60Hz integrato è fornita di controllo intelligente che regola automaticamente la corrente al tipo di propulsore. lo stesso alimentatore può essere ordinato a parte per le altre versioni.

accessori: cassaforma scomparsa totale per cartongesso e laterizio, tappi di chiusura, guarnizione con trappola di luce per vetri trasparenti; frangiluce a nido d'ape, lente ellittica, antiabbagliamento per lampadine tecniche. lampadine classiche e decorative con vetro trasparente, sabbato e bianco latte.
finiture: argento hacca, nero55.
personalizza la tua luce vai su www.Viabizzuno.com

damp location rated ceiling mounted light fitting for indoor use made of oxidised extruded aluminium.

versions with power supply included, to be installed remotely or with integrated power supply:

n55 soffitto with aip01 decorative diffuser,
n55 soffitto with dc02 decorative diffuser,
n55 soffitto with mn01 decorative diffuser,
n55 soffitto with pz01 decorative diffuser,
n55 soffitto with pz03 decorative diffuser,
n55 soffitto with wm01 decorative diffuser.

wired with propulsore dinamico n55 55/500 les19 14W/500mA 1580lm Ra98 1 step macadam.

the specific n55 lamp-holder allows to change three types of light bulbs: classic, decorative and technical. any irregularities in the glass are a guarantee of a unique product, blown and entirely hand crafted by master glassmakers.

the integrated 120V 50-60Hz power supply version has a smart control which automatically provides the suitable current according to the type of propeller. the same power supply can also be ordered separately for the other versions.

accessories: fully concealed housing for plasterboard and brickwork, end caps, gasket with light trap for transparent glass; honeycomb louvre, elliptical lens and anti-glare for technical bulbs. classic and decorative bulbs with transparent, sanded and milk white glass.

finishes: argento hacca, nero55.
customize your light visit www.Viabizzuno.com



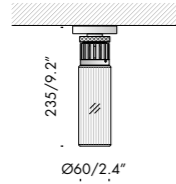

n55 soffitto aip01 120V 50-60Hz title24 damp

- Via.552.0300.u** argento hacca trasparente, rigato 2700K les19 ● n55 0,5kg
transparent, striped 1.1lb
- Via.552.0301.u** nero55 trasparente, rigato 2700K les19 ● n55 0,5kg
transparent, striped 1.1lb

Ra	R9	ies tm-30		sdc	mA	V _f (min)	lm	W	lm/W
98	98	Rf 96	Rg 103	step 1	500	27,9	1580	14,0	113
xm000	les19 ●	Ta25 °C		vita media · average life		70000 h	L80	B10	

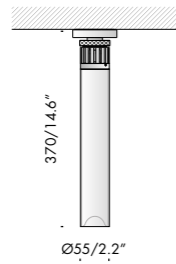

n55 soffitto dc02 120V 50-60Hz title24 damp

- Via.552.0304.u** argento hacca sabbiato 2700K les19 ● n55 0,6kg
sanded 1.3lb
- Via.552.0305.u** nero55 sabbiato 2700K les19 ● n55 0,6kg
sanded 1.3lb

Ra	R9	ies tm-30		sdc	mA	V _f (min)	lm	W	lm/W
98	98	Rf 96	Rg 103	step 1	500	27,9	1580	14,0	113
xm000	les19 ●	Ta25 °C		vita media · average life		70000 h	L80	B10	

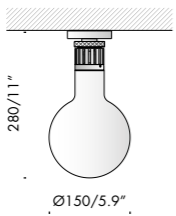

n55 soffitto mn01 120V 50-60Hz title24 damp

- Via.552.0308.u** argento hacca sabbiato 2700K les19 ● n55 0,8kg
sanded 1.8lb
- Via.552.0309.u** nero55 sabbiato 2700K les19 ● n55 0,8kg
sanded 1.8lb

Ra	R9	ies tm-30		sdc	mA	V _f (min)	lm	W	lm/W
98	98	Rf 96	Rg 103	step 1	500	27,9	1580	14,0	113
xm000	les19 ●	Ta25 °C		vita media · average life		70000 h	L80	B10	



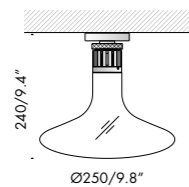

n55 soffitto pz01 120V 50-60Hz

- Via.552.0312.u** argento hacca trasparente 2700K les19 ● n55 0,8kg
transparent 1.8lb
- Via.552.0313.u** nero55 trasparente 2700K les19 ● n55 0,8kg
transparent 1.8lb

Ra	R9	ies tm-30		sdc	mA	V _f (min)	lm	W	lm/W
98	98	Rf 96	Rg 103	step 1	500	27,9	1580	14,0	113
xm000	les19 ●	Ta25 °C		vita media · average life		70000 h	L80	B10	

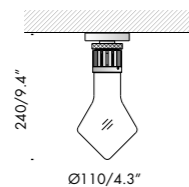

n55 soffitto pz03 120V 50-60Hz

- Via.552.0316.u** argento hacca trasparente 2700K les19 ● n55 0,5kg
transparent 1.1lb
- Via.552.0317.u** nero55 trasparente 2700K les19 ● n55 0,5kg
transparent 1.1lb

Ra	R9	ies tm-30		sdc	mA	V _f (min)	lm	W	lm/W
98	98	Rf 96	Rg 103	step 1	500	27,9	1580	14,0	113
xm000	les19 ●	Ta25 °C		vita media · average life		70000 h	L80	B10	

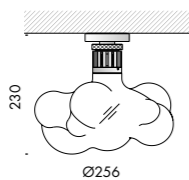

n55 soffitto wm01 120V 50-60Hz

- Via.552.0320.u** argento hacca trasparente 2700K les19 ● n55 1,0kg
transparent 2.2lb
- Via.552.0321.u** nero55 trasparente 2700K les19 ● n55 1,0kg
transparent 2.2lb

Ra	R9	ies tm-30		sdc	mA	V _f (min)	lm	W	lm/W
98	98	Rf 96	Rg 103	step 1	500	27,9	1580	14,0	113
xm000	les19 ●	Ta25 °C		vita media · average life		70000 h	L80	B10	



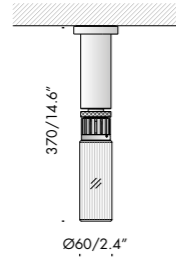

n55 soffitto ajp01 120V 50-60Hz **A1** title24 damp df pr i

- Via.552.0324** argento hacca trasparente, rigato 2700K les19 ● n55 0,5kg
transparent, striped 1.1lb
- Via.552.0325** nero55 trasparente, rigato 2700K les19 ● n55 0,5kg
transparent, striped 1.1lb

Ra	R9	ies tm-30		sdc	mA	V _{f(min)}	lm	W	lm/W
98	98	Rf 96	Rg 103	step 1	500	27,9	1580	14,0	113
xm000	les19 ●	Ta25 °C		vita media · average life		70000 h	L80	B10	

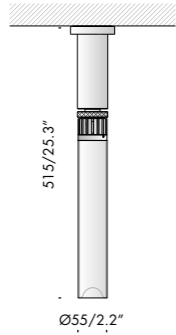

n55 soffitto dc02 120V 50-60Hz **A1** title24 damp df pr i

- Via.552.0328** argento hacca sabbiato 2700K les19 ● n55 0,7kg
sanded 1.5lb
- Via.552.0329** nero55 sabbiato 2700K les19 ● n55 0,7kg
sanded 1.5lb

Ra	R9	ies tm-30		sdc	mA	V _{f(min)}	lm	W	lm/W
98	98	Rf 96	Rg 103	step 1	500	27,9	1580	14,0	113
xm000	les19 ●	Ta25 °C		vita media · average life		70000 h	L80	B10	

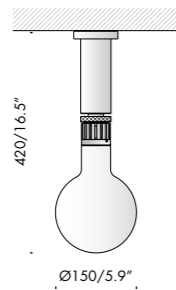

n55 soffitto mn01 120V 50-60Hz **A1** title24 damp df pr i

- Via.552.0332** argento hacca sabbiato 2700K les19 ● n55 0,7kg
sanded 1.5lb
- Via.552.0333** nero55 sabbiato 2700K les19 ● n55 0,7kg
sanded 1.5lb

Ra	R9	ies tm-30		sdc	mA	V _{f(min)}	lm	W	lm/W
98	98	Rf 96	Rg 103	step 1	500	27,9	1580	14,0	113
xm000	les19 ●	Ta25 °C		vita media · average life		70000 h	L80	B10	



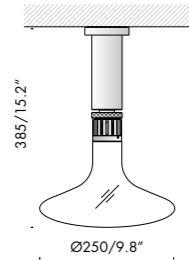

n55 soffitto pz01 120V 50-60Hz **A1** title24 damp df pr

- Via.552.0336** argento hacca trasparente 2700K les19 ● n55 0,8kg
1.8lb
- Via.552.0337** nero55 trasparente 2700K les19 ● n55 0,8kg
1.8lb

Ra	R9	ies tm-30		sdc	mA	V _f (min)	lm	W	lm/W
98	98	Rf 96	Rg 103	step 1	500	27,9	1580	14,0	113
xm000	les19 ●	Ta25 °C		vita media · average life		70000 h	L80	B10	

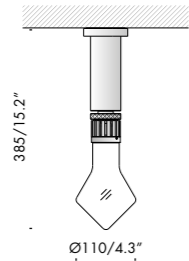

n55 soffitto pz03 120V 50-60Hz **A1** title24 damp df pr

- Via.552.0340** argento hacca trasparente 2700K les19 ● n55 0,6kg
1.3lb
- Via.552.0341** nero55 trasparente 2700K les19 ● n55 0,6kg
1.3lb

Ra	R9	ies tm-30		sdc	mA	V _f (min)	lm	W	lm/W
98	98	Rf 96	Rg 103	step 1	500	27,9	1580	14,0	113
xm000	les19 ●	Ta25 °C		vita media · average life		70000 h	L80	B10	

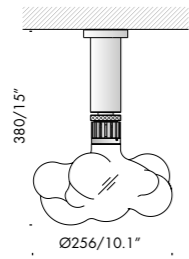

n55 soffitto wm01 120V 50-60Hz **A1** title24 damp df pr

- Via.552.0344** argento hacca trasparente 2700K les19 ● n55 1,0kg
2.2lb
- Via.552.0345** nero55 trasparente 2700K les19 ● n55 1,0kg
2.2lb

Ra	R9	ies tm-30		sdc	mA	V _f (min)	lm	W	lm/W
98	98	Rf 96	Rg 103	step 1	500	27,9	1580	14,0	113
xm000	les19 ●	Ta25 °C		vita media · average life		70000 h	L80	B10	



*personalizza la tua luce
vai su Viabizzuno.com*



+



+



*diffusore decorativo
decorative diffuser*



*diffusore tecnico
technical diffuser*



*diffusore classico
classic diffuser*

customize your light visit [Viabizzuno.com](https://www.viabizzuno.com)

1. scegli l'interfaccia
choose the interface

2. scegli il propulsore dinamico n55
choose the propulsore dinamico n55

3. scegli il tuo diffusore classico, decorativo e tecnico
choose your classic, decorative and technical diffuser

n55 soffitto

n5 soffitto a.i. interfaccia
alimentatore integrato
integrated power supply

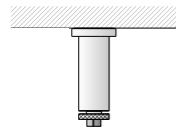

n55 soffitto a.r. interfaccia
alimentatore remoto
remote power supply

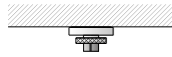

n55 soffitto orientabile a.r. interfaccia
alimentatore remoto
remote power supply

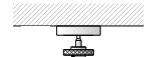

n55 soffitto scomparsa totale a.r. interfaccia
alimentatore remoto con rosone scomparsa totale
remote power supply with fully concealed rose



propulsore dinamico n55

55/350e

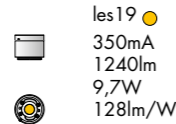

les19
350mA
1240lm
9,7W
128lm/W

55/350



les19
350mA
1240lm
9,7W
128lm/W

55/500



les19
500mA
1580lm
14W
113lm/W

55/500



les9
500mA
800lm
13,6W
59lm/W

65/500e

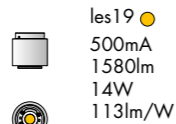

les19
500mA
1580lm
14W
113lm/W

65/700



les19
700mA
2140lm
19,9W
108lm/W

65/700



les9
700mA
1110lm
19,5W
57lm/W

82/1050



les19
1050mA
3000lm
30,5W
98lm/W

**diffusore classico
classic diffuser**

hm01



hm02



mn01



mn02

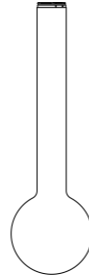

mn06



mn07



dc01



dc02



dc03

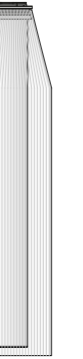

dc04



tc01

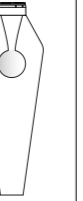

pz01

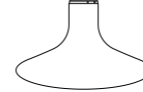

pz02

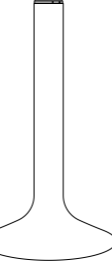

pz03



ddp01

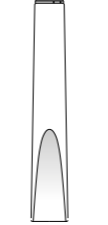

mk01

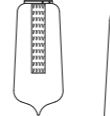

mk02

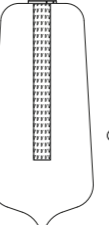

gt01



kk01



ml01



oma03



oma02

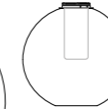

rdai01



ms02

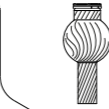

ms03

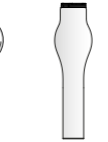

ms04



wm01



ajp01



nh01

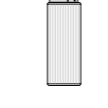

nh02



**diffusore decorativo
decorative diffuser**

**diffusore tecnico
technical diffuser**

spot35



les19 87°

les9

spot55x37



les19 30° 38°

les9 18° 23° 36°

spot55x61



les19 36° 47°

spot82x35



les19 31° 42°

les9 13° 19° 23° 35°

spot82x79



les19 23° 37° 46°

spot100



les19 16° 25° 40° 54°

les9 10° 22°

lensoptica amP150



les19 22° 51°

les9 13°

lensoptica amP180



les19 15° 41° 53° 20°x55°

les9 10°

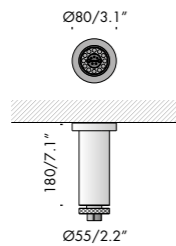

n55 soffitto interfaccia a.i.		120V 50-60Hz	A1	title24	damp				i
Vb3.580.01	argento hacca	350÷1050mA	n55					0,3kg 0.7lb	
Vb3.580.02	nero55	350÷1050mA	n55					0,3kg 0.7lb	
Vb3.580.03	my bianco	350÷1050mA	n55					0,3kg 0.7lb	

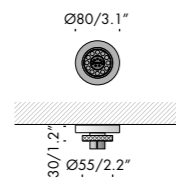

n55 soffitto interfaccia a.r.			A1	title24	damp				i
Vb3.580.09	argento hacca							n55 0,4kg 0.9lb	
Vb3.580.10	nero55							n55 0,4kg 0.9lb	
Vb3.580.11	my bianco							n55 0,4kg 0.9lb	

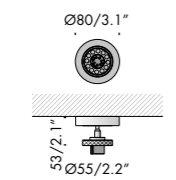

n55 soffitto interfaccia orientabile a.r.			A1	title24	damp				i
Vb6.580.17	argento hacca							n55 0,4kg 0.9lb	
Vb6.580.18	nero55							n55 0,4kg 0.9lb	
Vb6.580.19	my bianco							n55 0,4kg 0.9lb	

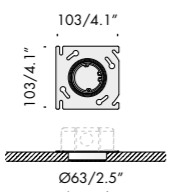

copertura per outlet box. cover for outlet box									i
Vb9.000.01.u	scomparsa totale cartongesso fully concealed for plasterboard installation							0,3kg 0.7lb	

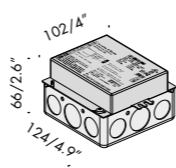
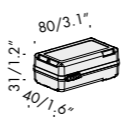
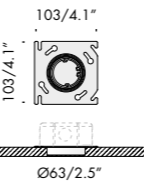
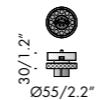

n55 soffitto interfaccia scomparsa totale a.r.			A1	title24	damp				i
Vb3.580.05	argento hacca							n55 0,2kg 0.4lb	
Vb3.580.06	nero55							n55 0,2kg 0.4lb	
Vb3.580.07	my bianco							n55 0,2kg 0.4lb	

copertura per outlet box. cover for outlet box									i
Vb9.000.01.u	scomparsa totale cartongesso fully concealed for plasterboard installation							0,1kg 0.2lb	

alimentatore. power supply.			A1	dry					i
Vb9.580.80	alimentatore elettronico con controllo intelligente electronic power supply with smart control	350÷1050mA dim. 1÷10V			max 34W			0,2kg 0.4lb	

alimentatori. power supplies.		120V 50-60Hz	A	dry					i
t4.620.u	350mA			15÷38V	13W			0,9kg 1.9lb	
t4.621.u	500mA			15÷38V	19W			0,9kg 1.9lb	
t4.622.u	700mA			15÷38V	27W			0,9kg 1.9lb	
t4.623.u	1050mA			15÷38V	40W			0,9kg 1.9lb	

accessori scomparsa totale. fully concealed accessories.									i
Vb9.580.83	tappo di chiusura · end cap	argento hacca						0,1kg 0.2lb	
Vb9.580.84	tappo di chiusura · end cap	nero55						0,1kg 0.2lb	
Vb9.580.85	tappo di chiusura · end cap	my bianco						0,1kg 0.2lb	

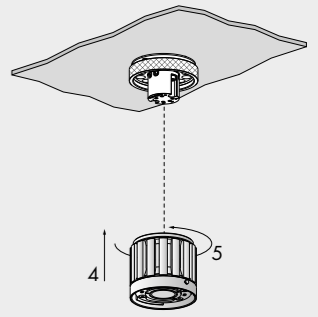
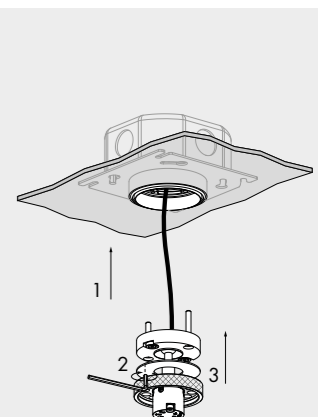



propulsore dinamico 55/350e									
Vb9.580.150.27	argento hacca	2700K	les19 ●	n55	0,2kg 0.4lb				
Vb9.580.151.27	nero55	2700K	les19 ●	n55	0,2kg 0.4lb				
Vb9.580.152.27	my bianco	2700K	les19 ●	n55	0,2kg 0.4lb				

Ra	R9	ies tm-30		sdcm	mA	V _{f(min)}	lm	W	lm/W
98	98	Rf 96	Rg 103	step 1	350	27,6	1240	9,7	128
xm000	les19 ●	Ta25 °C		vita media · average life		70000 h		L80 B10	

Vb9.580.150.30	argento hacca	3000K	les19 ●	n55	0,2kg 0.4lb				
Vb9.580.151.30	nero55	3000K	les19 ●	n55	0,2kg 0.4lb				
Vb9.580.152.30	my bianco	3000K	les19 ●	n55	0,2kg 0.4lb				

Ra	R9	ies tm-30		sdcm	mA	V _{f(min)}	lm	W	lm/W
98	98	Rf 96	Rg 103	step 1	350	27,6	1240	9,7	128
xm001	les19 ●	Ta25 °C		vita media · average life		70000 h		L80 B10	

Vb9.580.150.30v	argento hacca	3000VbK	les19 ●	n55	0,2kg 0.4lb				
Vb9.580.151.30v	nero55	3000VbK	les19 ●	n55	0,2kg 0.4lb				
Vb9.580.152.30v	my bianco	3000VbK	les19 ●	n55	0,2kg 0.4lb				

Ra	R9	ies tm-30		sdcm	mA	V _{f(min)}	lm	W	lm/W
98	98	Rf 93	Rg 106	step 1	350	27,6	1240	9,7	128
xm007	les19 ●	Ta25 °C		vita media · average life		70000 h		L80 B10	



propulsore dinamico 55/350									
Vb9.580.50.27	argento hacca	2700K	les19 ●	n55	0,2kg 0.4lb				
Vb9.580.51.27	nero55	2700K	les19 ●	n55	0,2kg 0.4lb				
Vb9.580.52.27	my bianco	2700K	les19 ●	n55	0,2kg 0.4lb				

Ra	R9	ies tm-30		sdcm	mA	V _{f(min)}	lm	W	lm/W
98	98	Rf 96	Rg 103	step 1	350	27,6	1240	9,7	128
xm000	les19 ●	Ta25 °C		vita media · average life		70000 h		L80 B10	

Vb9.580.50.30	argento hacca	3000K	les19 ●	n55	0,2kg 0.4lb				
Vb9.580.51.30	nero55	3000K	les19 ●	n55	0,2kg 0.4lb				
Vb9.580.52.30	my bianco	3000K	les19 ●	n55	0,2kg 0.4lb				

Ra	R9	ies tm-30		sdcm	mA	V _{f(min)}	lm	W	lm/W
98	98	Rf 96	Rg 103	step 1	350	27,6	1240	9,7	128
xm001	les19 ●	Ta25 °C		vita media · average life		70000 h		L80 B10	

Vb9.580.50.30v	argento hacca	3000VbK	les19 ●	n55	0,2kg 0.4lb				
Vb9.580.51.30v	nero55	3000VbK	les19 ●	n55	0,2kg 0.4lb				
Vb9.580.52.30v	my bianco	3000VbK	les19 ●	n55	0,2kg 0.4lb				

Ra	R9	ies tm-30		sdcm	mA	V _{f(min)}	lm	W	lm/W
98	98	Rf 93	Rg 106	step 1	350	27,6	1240	9,7	128
xm007	les19 ●	Ta25 °C		vita media · average life		70000 h		L80 B10	



propulsore dinamico 55/500									
Vb9.580.62.27	argento hacca	2700K	les19 ●	n55	0,2kg 0.4lb				
Vb9.580.63.27	nero55	2700K	les19 ●	n55	0,2kg 0.4lb				
Vb9.580.64.27	my bianco	2700K	les19 ●	n55	0,2kg 0.4lb				

Ra	R9	ies tm-30		sdcm	mA	V _{f(min)}	lm	W	lm/W
98	98	Rf 96	Rg 103	step 1	500	27,9	1580	14,0	113
xm000	les19 ●	Ta25 °C		vita media · average life		70000 h		L80 B10	

Vb9.580.62.30	argento hacca	3000K	les19 ●	n55	0,2kg 0.4lb				
Vb9.580.63.30	nero55	3000K	les19 ●	n55	0,2kg 0.4lb				
Vb9.580.64.30	my bianco	3000K	les19 ●	n55	0,2kg 0.4lb				

Ra	R9	ies tm-30		sdcm	mA	V _{f(min)}	lm	W	lm/W
98	98	Rf 96	Rg 103	step 1	500	27,9	1580	14,0	113
xm001	les19 ●	Ta25 °C		vita media · average life		70000 h		L80 B10	

Vb9.580.62.30v	argento hacca	3000VbK	les19 ●	n55	0,2kg 0.4lb				
Vb9.580.63.30v	nero55	3000VbK	les19 ●	n55	0,2kg 0.4lb				
Vb9.580.64.30v	my bianco	3000VbK	les19 ●	n55	0,2kg 0.4lb				

Ra	R9	ies tm-30		sdcm	mA	V _{f(min)}	lm	W	lm/W
98	98	Rf 93	Rg 106	step 1	500	27,9	1580	14,0	113
xm007	les19 ●	Ta25 °C		vita media · average life		70000 h		L80 B10	

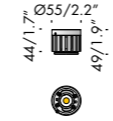

propulsore dinamico 55/500									
Vb9.580.101.27	argento hacca	2700K	les9 ●	n55	0,2kg 0.4lb				
Vb9.580.102.27	nero55	2700K	les9 ●	n55	0,2kg 0.4lb				
Vb9.580.103.27	my bianco	2700K	les9 ●	n55	0,2kg 0.4lb				

Ra	R9	ies tm-30		sdcm	mA	V _{f(min)}	lm	W	lm/W
98	98	Rf 96	Rg 103	step 1	500	27,1	800	13,6	59
xe000	les9 ●	Ta25 °C		vita media · average life		70000 h		L80 B10	

Vb9.580.101.30	argento hacca	3000K	les9 ●	n55	0,2kg 0.4lb				
Vb9.580.102.30	nero55	3000K	les9 ●	n55	0,2kg 0.4lb				
Vb9.580.103.30	my bianco	3000K	les9 ●	n55	0,2kg 0.4lb				

Ra	R9	ies tm-30		sdcm	mA	V _{f(min)}	lm	W	lm/W
98	98	Rf 96	Rg 103	step 1	500	27,1	800	13,6	59
xe001	les9 ●	Ta25 °C		vita media · average life		70000 h		L80 B10	

Vb9.580.101.30v	argento hacca	3000VbK	les9 ●	n55	0,2kg 0.4lb				
Vb9.580.102.30v	nero55	3000VbK	les9 ●	n55	0,2kg 0.4lb				
Vb9.580.103.30v	my bianco	3000VbK	les9 ●	n55	0,2kg 0.4lb				

Ra	R9	ies tm-30		sdcm	mA	V _{f(min)}	lm	W	lm/W
98	98	Rf 93	Rg 106	step 1	500	27,1	800	13,6	59
xe007	les9 ●	Ta25 °C		vita media · average life		70000 h		L80 B10	



propulsore dinamico 65/500e									
Vb9.580.154.27	argento hacca	2700K	les19 ●	n55	0,3kg 0.7lb				
Vb9.580.155.27	nero55	2700K	les19 ●	n55	0,3kg 0.7lb				
Vb9.580.156.27	my bianco	2700K	les19 ●	n55	0,3kg 0.7lb				

Ra	R9	ies tm-30		sdcm	mA	V _{f (min)}	lm	W	lm/W
98	98	Rf 96	Rg 103	step 1	500	27,9	1580	14,0	113
xm000	les19 ●	Ta25 °C		vita media · average life		70000 h		L80 B10	

Vb9.580.154.30	argento hacca	3000K	les19 ●	n55	0,3kg 0.7lb				
Vb9.580.155.30	nero55	3000K	les19 ●	n55	0,3kg 0.7lb				
Vb9.580.156.30	my bianco	3000K	les19 ●	n55	0,3kg 0.7lb				

Ra	R9	ies tm-30		sdcm	mA	V _{f (min)}	lm	W	lm/W
98	98	Rf 96	Rg 103	step 1	500	27,9	1580	14,0	113
xm001	les19 ●	Ta25 °C		vita media · average life		70000 h		L80 B10	

Vb9.580.154.30v	argento hacca	3000VbK	les19 ●	n55	0,3kg 0.7lb				
Vb9.580.155.30v	nero55	3000VbK	les19 ●	n55	0,3kg 0.7lb				
Vb9.580.156.30v	my bianco	3000VbK	les19 ●	n55	0,3kg 0.7lb				

Ra	R9	ies tm-30		sdcm	mA	V _{f (min)}	lm	W	lm/W
98	98	Rf 93	Rg 106	step 1	500	27,9	1580	14,0	113
xm007	les19 ●	Ta25 °C		vita media · average life		70000 h		L80 B10	

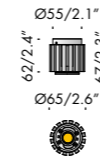

propulsore dinamico 65/700									
Vb9.580.54.27	argento hacca	2700K	les19 ●	n55	0,3kg 0.7lb				
Vb9.580.55.27	nero55	2700K	les19 ●	n55	0,3kg 0.7lb				
Vb9.580.56.27	my bianco	2700K	les19 ●	n55	0,3kg 0.7lb				

Ra	R9	ies tm-30		sdcm	mA	V _{f (min)}	lm	W	lm/W
98	98	Rf 96	Rg 103	step 1	700	28,4	2140	19,9	108
xm000	les19 ●	Ta25 °C		vita media · average life		70000 h		L80 B10	

Vb9.580.54.30	argento hacca	3000K	les19 ●	n55	0,3kg 0.7lb				
Vb9.580.55.30	nero55	3000K	les19 ●	n55	0,3kg 0.7lb				
Vb9.580.56.30	my bianco	3000K	les19 ●	n55	0,3kg 0.7lb				

Ra	R9	ies tm-30		sdcm	mA	V _{f (min)}	lm	W	lm/W
98	98	Rf 96	Rg 103	step 1	700	28,4	2140	19,9	108
xm001	les19 ●	Ta25 °C		vita media · average life		70000 h		L80 B10	

Vb9.580.54.30v	argento hacca	3000VbK	les19 ●	n55	0,3kg 0.7lb				
Vb9.580.55.30v	nero55	3000VbK	les19 ●	n55	0,3kg 0.7lb				
Vb9.580.56.30v	my bianco	3000VbK	les19 ●	n55	0,3kg 0.7lb				

Ra	R9	ies tm-30		sdcm	mA	V _{f (min)}	lm	W	lm/W
98	98	Rf 93	Rg 106	step 1	700	28,4	2140	19,9	108
xm007	les19 ●	Ta25 °C		vita media · average life		70000 h		L80 B10	

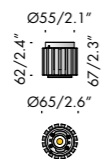

propulsore dinamico 65/700									
Vb9.580.106.27	argento hacca	2700K	les9 ●	n55	0,3kg 0.7lb				
Vb9.580.107.27	nero55	2700K	les9 ●	n55	0,3kg 0.7lb				
Vb9.580.108.27	my bianco	2700K	les9 ●	n55	0,3kg 0.7lb				

Ra	R9	ies tm-30		sdcm	mA	V _f (min)	lm	W	lm/W
98	98	Rf 96	Rg 103	step 1	700	27,9	1110	19,5	57
xe000	les9 ●	Ta25 °C		vita media · average life		70000 h	L80	B10	

Vb9.580.106.30	argento hacca	3000K	les9 ●	n55	0,3kg 0.7lb				
Vb9.580.107.30	nero55	3000K	les9 ●	n55	0,3kg 0.7lb				
Vb9.580.108.30	my bianco	3000K	les9 ●	n55	0,3kg 0.7lb				

Ra	R9	ies tm-30		sdcm	mA	V _f (min)	lm	W	lm/W
98	98	Rf 96	Rg 103	step 1	700	27,9	1110	19,5	57
xe001	les9 ●	Ta25 °C		vita media · average life		70000 h	L80	B10	

Vb9.580.106.30v	argento hacca	3000VbK	les9 ●	n55	0,3kg 0.7lb				
Vb9.580.107.30v	nero55	3000VbK	les9 ●	n55	0,3kg 0.7lb				
Vb9.580.108.30v	my bianco	3000VbK	les9 ●	n55	0,3kg 0.7lb				

Ra	R9	ies tm-30		sdcm	mA	V _f (min)	lm	W	lm/W
98	98	Rf 93	Rg 106	step 1	700	27,9	1110	19,5	57
xe007	les9 ●	Ta25 °C		vita media · average life		70000 h	L80	B10	



propulsore dinamico 82/1050									
Vb9.580.58.27	argento hacca	2700K	les19 ●	n55	0,5kg 1.1lb				
Vb9.580.59.27	nero55	2700K	les19 ●	n55	0,5kg 1.1lb				
Vb9.580.60.27	my bianco	2700K	les19 ●	n55	0,5kg 1.1lb				

Ra	R9	ies tm-30		sdcm	mA	V _f (min)	lm	W	lm/W
98	98	Rf 96	Rg 103	step 1	1050	29,0	3000	30,5	98
xm000	les19 ●	Ta25 °C		vita media · average life		70000 h	L80	B10	

Vb9.580.58.30	argento hacca	3000K	les19 ●	n55	0,5kg 1.1lb				
Vb9.580.59.30	nero55	3000K	les19 ●	n55	0,5kg 1.1lb				
Vb9.580.60.30	my bianco	3000K	les19 ●	n55	0,5kg 1.1lb				

Ra	R9	ies tm-30		sdcm	mA	V _f (min)	lm	W	lm/W
98	98	Rf 96	Rg 103	step 1	1050	29,0	3000	30,5	98
xm001	les19 ●	Ta25 °C		vita media · average life		70000 h	L80	B10	

Vb9.580.58.30v	argento hacca	3000VbK	les19 ●	n55	0,5kg 1.1lb				
Vb9.580.59.30v	nero55	3000VbK	les19 ●	n55	0,5kg 1.1lb				
Vb9.580.60.30v	my bianco	3000VbK	les19 ●	n55	0,5kg 1.1lb				

Ra	R9	ies tm-30		sdcm	mA	V _f (min)	lm	W	lm/W
98	98	Rf 93	Rg 106	step 1	1050	29,0	3000	30,5	98
xm007	les19 ●	Ta25 °C		vita media · average life		70000 h	L80	B10	

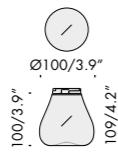
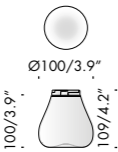
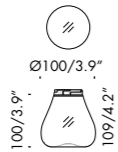
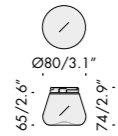
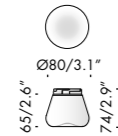
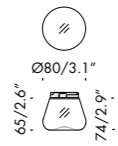

marionanni

Vb9.580.01.t hm01 trasparente · transparent n55 0,5kg 1.1lb

Vb9.580.01.s hm01 sabbiata · sanded n55 0,5kg 1.1lb

Vb9.580.01.b hm01 bianco latte · milk white n55 0,5kg 1.1lb

Vb9.580.02.t hm02 trasparente · transparent n55 0,1kg 0.2lb

Vb9.580.02.s hm02 sabbiata · sanded n55 0,1kg 0.2lb

Vb9.580.02.b hm02 bianco latte · milk white n55 0,1kg 0.2lb

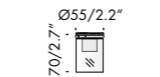
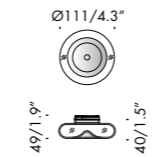
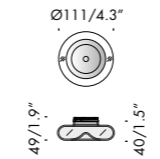
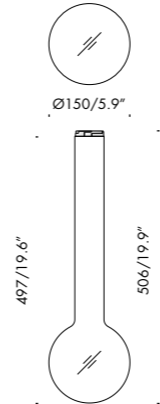
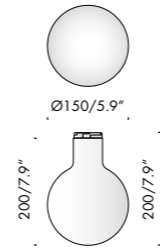

Vb9.580.03.s mn01 sabbiato · sanded n55 0,3kg 0.7lb

Vb9.580.04.t mn02 trasparente · transparent n55 0,3kg 0.7lb

Vb9.580.173.b mn06 tabacchiera bianco satinato · white frosted n55 0,1kg 0.2lb

Vb9.580.173.cr mn06 tabacchiera trasparente cromata · transparent chromed n55 0,1kg 0.2lb

Vb9.580.178 mn07 trasparente sabbiato · transparent sanded n55 0,1kg 0.2lb



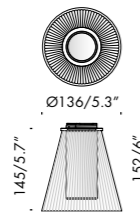
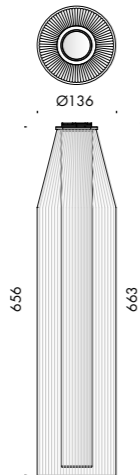
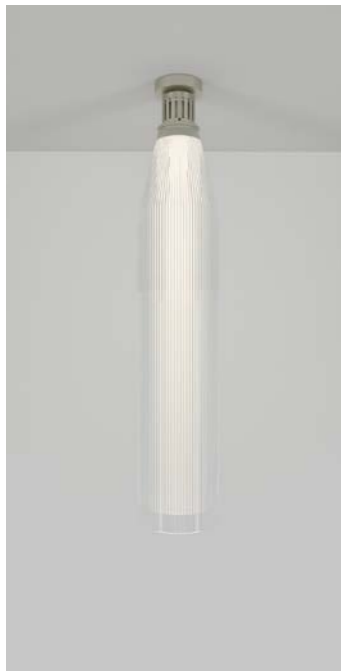
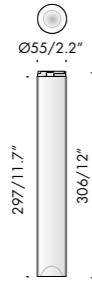
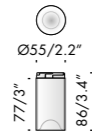

david chipperfield

Vb9.580.05.s dc01 sabbaiato · sanded n55 0,1kg
0.2lb

Vb9.580.06.s dc02 sabbaiato · sanded n55 0,3kg
0.7lb

Vb9.580.19.tr dc03 trasparente, rigato
transparent, striped n55 0,7kg
1.5lb

Vb9.580.20.tr dc04 trasparente, rigato e sabbaiato
transparent, striped and sanded n55 0,3kg
0.7lb

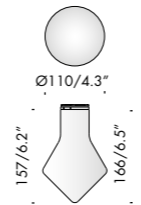
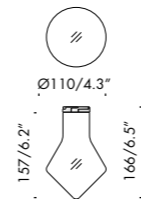
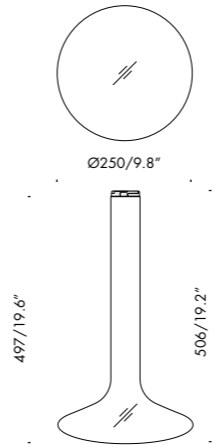
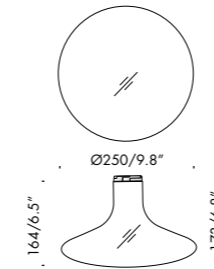

peter zumthor

Vb9.580.08.t pz01 trasparente · transparent n55 0,3kg
0.7lb

Vb9.580.10.t pz02 trasparente · transparent n55 0,6kg
1.3lb

Vb9.580.11.t pz03 trasparente · transparent n55 0,2kg
0.4lb

Vb9.580.11.s pz03 sabbaiato · sanded n55 0,2kg
0.4lb



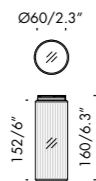

al-jawad pike

Vb9.580.18.tr aip01 trasparente, rigato
transparent, striped

n55 0,2kg
0.4lb

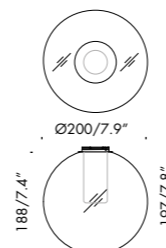

oma

Vb9.580.14.t oma02 trasparente · transparent

n55 0,4kg
0.8lb

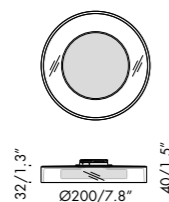

neri&hu

Vb9.580.116.ts nh01 trasparente, sabbaiato
transparent, sanded

n55 1,2kg
2.6lb

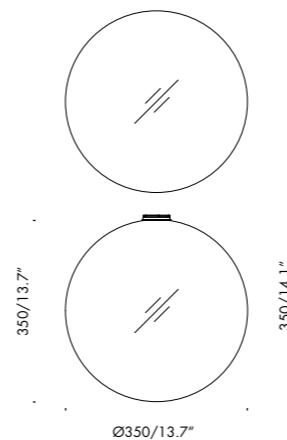

Vb9.580.15.t oma03 trasparente · transparent

n55 1,4kg
3.1lb

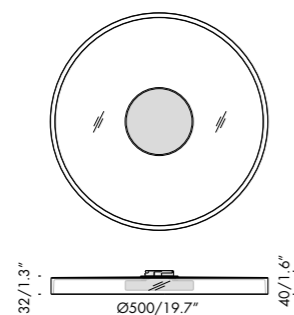

Vb9.580.117.ts nh02 trasparente, sabbaiato
transparent, sanded

n55 2kg
4.4lb

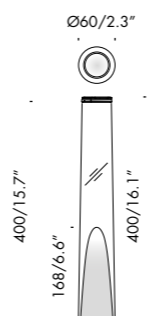



domenico de palo

Vb9.580.114.t ddp01 trasparente, sabbaiato
transparent, sanded

n55 0,4kg
0.8lb

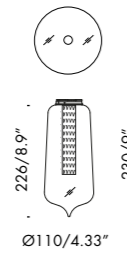



marcio kogan  
Vb9.580.111.t mk01 trasparente · transparent n55 0,4kg
0.8lb

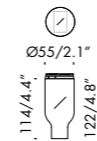

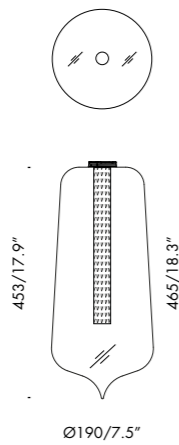

kengo kuma  
Vb9.580.07.c kk01 cristallo · crystal n55 0,3kg
0.7lb



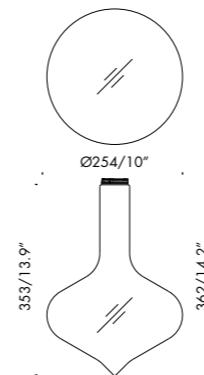

Vb9.580.112.t mk02 trasparente · transparent n55 1,8kg
4lb



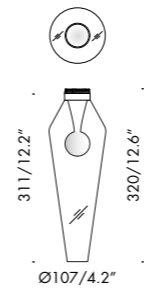

rdai  
Vb9.580.12.t rdai01 trasparente · transparent n55 0,6kg
1.3lb



tzach cohen  
Vb9.580.180.ts tc01 trasparente, sabbato
transparent, sanded n55 0,4kg
0.8lb

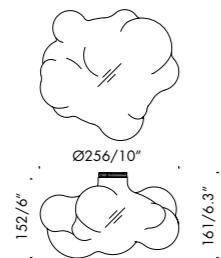







winy maas  

Vb9.580.09.t wm01 trasparente · transparent n55 0,6kg
1.3lb



mirko spaccapanico  

Vb9.580.175.t ms02 trasparente · transparent n55 0,3kg
0.7lb

max lam  

Vb9.580.13.t ml01 trasparente · transparent n55 1,4kg
3.1lb



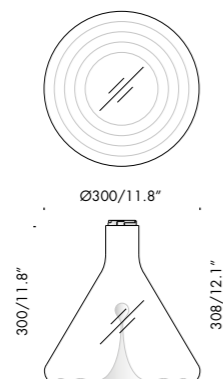

Vb9.580.176.t ms03 trasparente · transparent n55 0,3kg
0.7lb

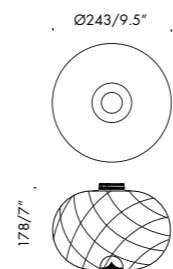

Vb9.580.177.t ms04 trasparente · transparent n55 0,3kg
0.7lb



gio tirotto  

Vb9.580.17.t gt01 trasparente, sabbato
transparent, sanded n55 1kg
2.2lb

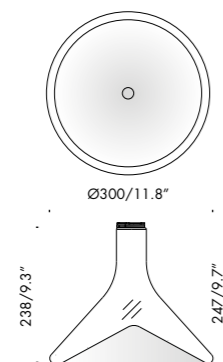

accessori per lampadina trasparente. transparent bulb accessories.  

Vb9.580.160 trappola di luce antiabbagliamento nero
anti-glare black light trap 0,03kg
0.07lb

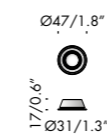

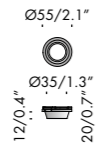

spot35					
Vb9.580.21	argento hacca	87° les19 ●	n55	0,1kg 0.2lb	
Vb9.580.22	nero55	87° les19 ●	n55	0,1kg 0.2lb	
Vb9.580.22.b	my bianco	87° les19 ●	n55	0,1kg 0.2lb	



spot55x37					
Vb9.580.121	argento hacca	18° les9 ●	n55	0,1kg 0.2lb	
Vb9.580.122	nero55	18° les9 ●	n55	0,1kg 0.2lb	
Vb9.580.122.b	my bianco	18° les9 ●	n55	0,1kg 0.2lb	
Vb9.580.123	argento hacca	23° les9 ● 30° les19 ●	n55	0,1kg 0.2lb	
Vb9.580.124	nero55	23° les9 ● 30° les19 ●	n55	0,1kg 0.2lb	
Vb9.580.124.b	my bianco	23° les9 ● 30° les19 ●	n55	0,1kg 0.2lb	
Vb9.580.125	argento hacca	36° les9 ● 38° les19 ●	n55	0,1kg 0.2lb	
Vb9.580.126	nero55	36° les9 ● 38° les19 ●	n55	0,1kg 0.2lb	
Vb9.580.126.b	my bianco	36° les9 ● 38° les19 ●	n55	0,1kg 0.2lb	

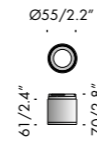

spot55x61					
Vb9.580.25	argento hacca	36° les19 ●	n55	0,2kg 0.4lb	
Vb9.580.26	nero55	36° les19 ●	n55	0,2kg 0.4lb	
Vb9.580.26.b	my bianco	36° les19 ●	n55	0,2kg 0.4lb	
Vb9.580.27	argento hacca	47° les19 ●	n55	0,2kg 0.4lb	
Vb9.580.28	nero55	47° les19 ●	n55	0,2kg 0.4lb	
Vb9.580.28.b	my bianco	47° les19 ●	n55	0,2kg 0.4lb	



accessori spot55. accessories.			
Vb9.580.91	frangiluce nido d'ape · honeycomb louvre		0,01kg 0.02lb
Vb9.580.92	lente ellittica · elliptical lens		0,04kg 0.09lb

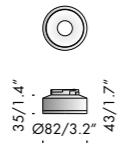

spot82x35				Ⓜ	i
Vb9.580.131	argento hacca	13° les9 ●	n55	0,1kg 0.2lb	
Vb9.580.132	nero55	13° les9 ●	n55	0,1kg 0.2lb	
Vb9.580.137	my bianco	13° les9 ●	n55	0,1kg 0.2lb	
Vb9.580.133	argento hacca	19° les9 ●	n55	0,1kg 0.2lb	
Vb9.580.134	nero55	19° les9 ●	n55	0,1kg 0.2lb	
Vb9.580.138	my bianco	19° les9 ●	n55	0,1kg 0.2lb	
Vb9.580.135	argento hacca	23° les9 ● 31° les19 ●	n55	0,1kg 0.2lb	
Vb9.580.136	nero55	23° les9 ● 31° les19 ●	n55	0,1kg 0.2lb	
Vb9.580.141	my bianco	23° les9 ● 31° les19 ●	n55	0,1kg 0.2lb	
Vb9.580.139	argento hacca	35° les9 ● 42° les19 ●	n55	0,1kg 0.2lb	
Vb9.580.140	nero55	35° les9 ● 42° les19 ●	n55	0,1kg 0.2lb	
Vb9.580.142	my bianco	35° les9 ● 42° les19 ●	n55	0,1kg 0.2lb	

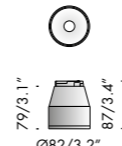

spot82x79				Ⓜ	i
Vb9.580.31	argento hacca	23° les19 ●	n55	0,2kg 0.4lb	
Vb9.580.32	nero55	23° les19 ●	n55	0,2kg 0.4lb	
Vb9.580.32.b	my bianco	23° les19 ●	n55	0,2kg 0.4lb	
Vb9.580.33	argento hacca	37° les19 ●	n55	0,2kg 0.4lb	
Vb9.580.34	nero55	37° les19 ●	n55	0,2kg 0.4lb	
Vb9.580.34.b	my bianco	37° les19 ●	n55	0,2kg 0.4lb	
Vb9.580.35	argento hacca	46° les19 ●	n55	0,2kg 0.4lb	
Vb9.580.36	nero55	46° les19 ●	n55	0,2kg 0.4lb	
Vb9.580.36.b	my bianco	46° les19 ●	n55	0,2kg 0.4lb	

accessori spot82. accessories. Ⓜ i

Vb9.580.86	frangiluce nido d'ape · honeycomb louvre	0,01kg 0.02lb
Vb9.580.87	lente ellittica · elliptical lens	0,05kg 0.11lb
Vb9.580.88	vetro albarino · albarino glass	0,05kg 0.11lb
Vb9.580.165	anti abbagliamento · anti-glare	0,03kg 0.07lb

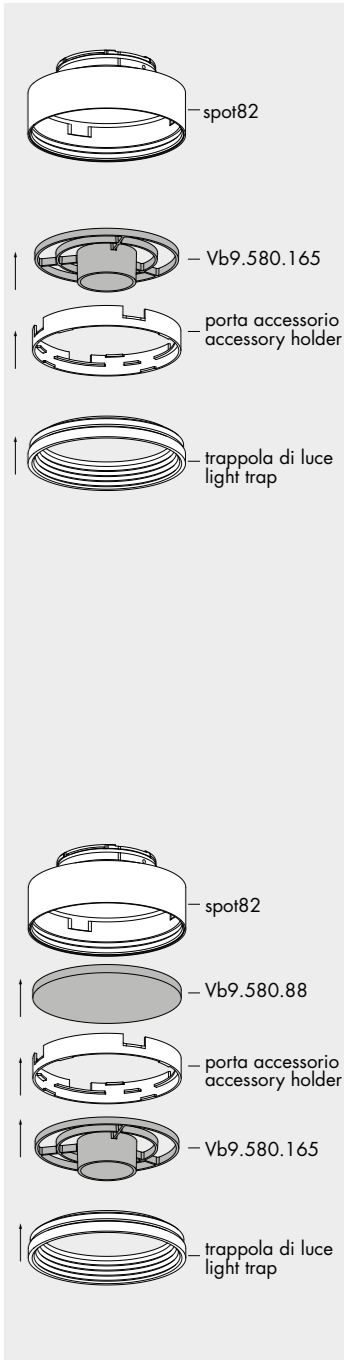
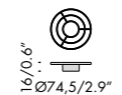
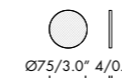

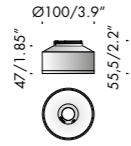

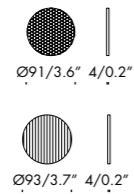

spot100					
Vb9.580.37	argento hacca	10° les9 ●	16° les19 ●	n55	0,1kg 0.2lb
Vb9.580.38	nero55	10° les9 ●	16° les19 ●	n55	0,1kg 0.2lb
Vb9.580.38.b	my bianco	10° les9 ●	16° les19 ●	n55	0,1kg 0.2lb
Vb9.580.39	argento hacca	22° les9 ●	25° les19 ●	n55	0,1kg 0.2lb
Vb9.580.40	nero55	22° les9 ●	25° les19 ●	n55	0,1kg 0.2lb
Vb9.580.40.b	my bianco	22° les9 ●	25° les19 ●	n55	0,1kg 0.2lb
Vb9.580.41	argento hacca		40° les19 ●	n55	0,1kg 0.2lb
Vb9.580.42	nero55		40° les19 ●	n55	0,1kg 0.2lb
Vb9.580.42.b	my bianco		40° les19 ●	n55	0,1kg 0.2lb
Vb9.580.43	argento hacca		54° les19 ●	n55	0,1kg 0.2lb
Vb9.580.44	nero55		54° les19 ●	n55	0,1kg 0.2lb
Vb9.580.44.b	my bianco		54° les19 ●	n55	0,1kg 0.2lb

accessori spot100. accessories.			
Vb9.580.93	frangiluce nido d'ape · honeycomb louvre		0,1kg 0.2lb
Vb9.580.94	lente ellittica · elliptical lens		0,05kg 0.11lb

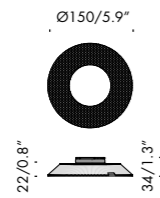



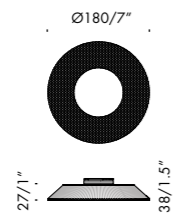

lensoptica amP150  

Vb9.518.91	fascio stretto narrow beam	13° 22°	les9 ● les19 ●	n55	0,3kg 0.7lb
Vb9.518.92	fascio largo wide beam	51°	les19 ●	n55	0,3kg 0.7lb



lensoptica amP180  

Vb9.518.81	fascio stretto narrow beam	10° 15°	les9 ● les19 ●	n55	0,6kg 1.3lb
Vb9.518.82	fascio medio medium beam	41°	les19 ●	n55	0,6kg 1.3lb
Vb9.518.83	fascio largo wide beam	53°	les19 ●	n55	0,6kg 1.3lb
Vb9.518.84	fascio ellittico elliptical beam	20°x55°	les19 ●	n55	0,6kg 1.3lb

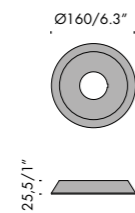

riflettore in metallo 150  

Vb9.518.95.n	nero55				0,1kg 0.2lb
Vb9.518.95.mb	my bianco				0,1kg 0.2lb
Vb9.518.95.h	argento hacca				0,1kg 0.2lb

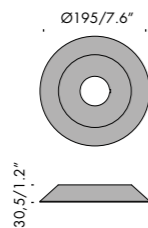

riflettore in metallo 180  

Vb9.518.96.n	nero55				0,1kg 0.2lb
Vb9.518.96.mb	my bianco				0,1kg 0.2lb
Vb9.518.96.h	argento hacca				0,1kg 0.2lb



propulsore dinamico n55

riflettore in metallo · metal reflector

lensoptica amP

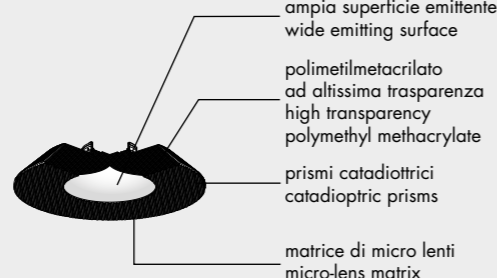
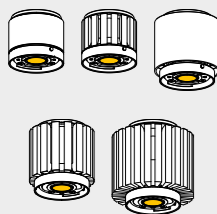

materiale	coefficiente d'assorbimento α
vetro soda calcico	0,017 mm ⁻¹
poli carbonato	0,004 mm ⁻¹
polimetilmetacrilato	0,0014 mm ⁻¹

la trasmittanza interna (T) di un materiale trasparente è determinata dallo spessore (x) e dal coefficiente d'assorbimento del materiale stesso (α) secondo la legge di lambert-beer $T_{(x)} = e^{-αx}$
 the internal transmittance of a transparent material (T) is determined by the thickness (x) and by the absorbing coefficient of the material itself (α) due to lambert-beer law $T_{(x)} = e^{-αx}$

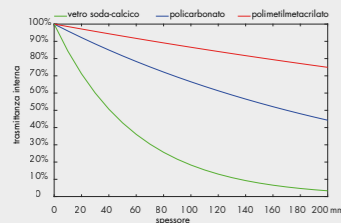

lensoptica amP è allo stesso tempo una lente e un riflettore, perché i raggi di luce subiscono rifrazione e riflessione totale interna. per questa caratteristica tecnica riesce a coniugare alta efficienza e accurato controllo direzionale della luce.
lensoptica amP is both a lens and a reflector at the same time, because the rays of light undergo refraction and total internal reflection. for this technical characteristic it combines high efficiency and accurate directional control of light.

la superficie emittente di **lensoptica amP** è dotata di una matrice di microlenti. ogni microlente riceve un fascio collimato e in funzione della curvatura ne allarga l'apertura angolare in modo controllato. la sovrapposizione dei contributi delle singole microlenti produce una distribuzione d'illuminamento uniforme.
 the emitting surface of **lensoptica amP** is equipped with a microlens array. each microlens receives a collimated beam and according to its curvature it enlarges the angular opening in a controlled way. the overlap of the emissions of each microlens creates a uniform distribution of illumination.

le **lensoptica amP** si suddividono in quattro categorie di apertura angolare del fascio: stretto, medio, largo ed ellittico. il valore esatto dell'angolo dipende dal diametro della sorgente.
lensoptica amP emitter surface is equipped with a microlens array. each microlens receives a collimated beam and according to its curvature it enlarges the angular opening in a controlled way.

the overlap of the emissions of each microlens creates a uniform distribution of illumination.

lensoptica amP are divided into four categories based on the angular opening of the beam: narrow, medium, wide and elliptical. the exact value of the angle depends on the source diameter.

lensoptica amP è il risultato di una ricerca sviluppata da Viabizzuno su progetto david chipperfield architects con lo studio internazionale di ingegneria arup per fornire alle sorgenti luminose elettroniche un'ottica ad alta efficienza in grado di avere sia una luce concentrata che diffusa. l'alta efficienza viene ottenuta utilizzando un materiale ad altissima trasparenza, il polimetilmetacrilato, per mezzo di prismi catadiottrici progettati per riflettere e trasmettere la luce minimizzando le perdite per assorbimento: tali elementi riflettono verso il basso il 90% del flusso luminoso incidente e ne trasmettono il 10% garantendo così una percentuale di emissione indiretta, non ottenibile con il riflettore in metallo.

la matrice di microlenti regola in modo preciso l'ampiezza angolare del fascio luminoso.

l'ampia superficie emittente garantisce un alto comfort visivo e UGR<19.

lensoptica amP is the result of a long research and development process made by Viabizzuno on a david chipperfield architects with arup, international engineering studio, design to provide electronic light sources with a high efficiency optics that can have either a focused and a diffuse light.

high efficiency is achieved thanks to a very high transparent material, i.e. polymethyl methacrylate, by means of catadioptric prisms specifically designed to reflect and transmit light reducing losses due to absorption: these elements, reflect 90% of the incident light flow downwards and transmit 10% of it, assuring this way a percentage of indirect emission which could not be reached with metal reflector.

the microlens array precisely regulates the angular amplitude of the light beam.

the large emitter surface limits luminance, ensuring high visual comfort and UGR<19.

lensoptica amP150
13° les9

fascio stretto · narrow beam

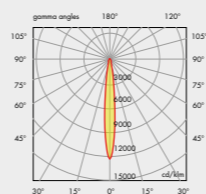

lensoptica amP180
15° les19

fascio stretto · narrow beam

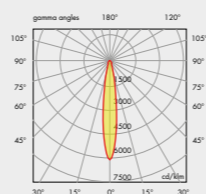

lensoptica amP150
fascio stretto · narrow beam



lensoptica amP150
fascio largo · wide beam

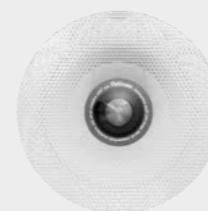

lensoptica amP150 22°
les19

fascio stretto · narrow beam

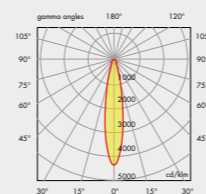

lensoptica amP180
41° les19

fascio medio · medium beam

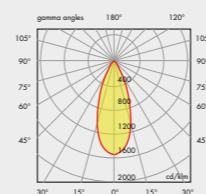

lensoptica amP180
fascio stretto · narrow beam



lensoptica amP180
fascio largo · wide beam



lensoptica amP150 51°
les19

fascio largo · wide beam

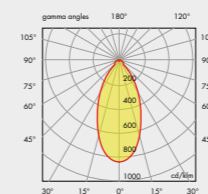

lensoptica amP180
53° les19

fascio largo · wide beam

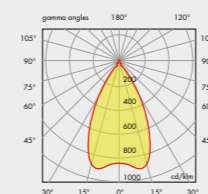

lensoptica amP180
fascio medio · medium beam

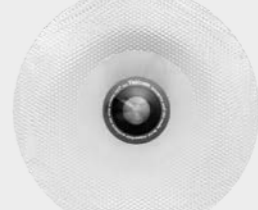

lensoptica amP180
fascio ellittico · elliptical beam



lensoptica amP180 10°
les9

fascio stretto · narrow beam

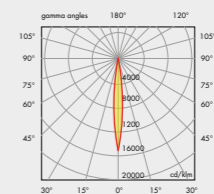

lensoptica amP180 20°x55°
les19

fascio ellittico · elliptical beam

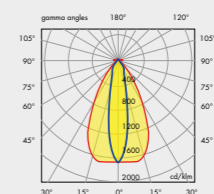

lensoptica amP
installazione · mounting

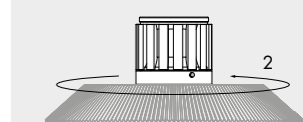
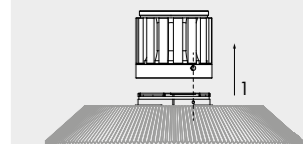
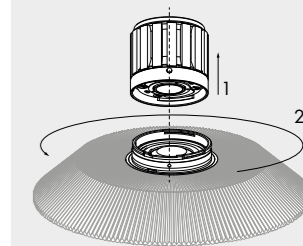
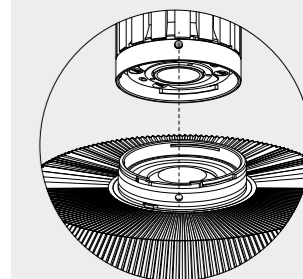



lettura delle tabelle tecniche how to read technical tables

xxxxxxxxxxxxxxxx							120V 50-60Hz	A	wet	UL	UL US	i
a	b	c	d	e	f	f	g					

xxxxxxxxxxxxxxxx							120V 50-60Hz	A	wet	UL	UL US	i
Vbx.xxx.xx	nero55	3000K	35W	20°	0,8kg	1.8lb						
h	i	l	m	n	g							

componenti. components.

accessori. accessories.

1	2	3	4	5	6	7	8	9	
Ra	R9	ies tm-30		sdc	mA	V _{f (min)}	lm	W	lm/W
98	98	Rf 96	Rg 103	step 1	350	27,6	1240	9,7	128
					500	27,9	1580	14,0	113
xm000	les19	Ta25 °C		vita media · average life		50000 h	L80	B10	
10	11						12	13	

classificazione ambiente di installazione installation location rating

bandella tecnica. posizioni standard simbologie.
data plate. standard arrangement of symbols.

a	nome apparecchio di illuminazione · light fitting name
b	tensione di alimentazione · supply rating (Volt)
c	frequenza di alimentazione · supply frequency (Hertz)
d	alimentatore incluso o escluso · power supply included or not included
e	classificazione ambiente di installazione · installation location rating
f	marchio di certificazione · safety and quality standards certification
g	peso netto · net weight (kg/lb)
h	codice · code
i	finiture · colours and finishes
l	temperatura colore sorgente elettronica colour temperature led source (Kelvin)
m	potenza della sorgente · source power (Watt)
n	gradi fascio luminoso · light beam degrees

componenti. identifica tutti gli elementi indispensabili per la corretta funzionalità e installazione dell'apparecchio di illuminazione.
components. includes all items that are essential to the correct operation and installation of the light fitting.

accessori. si riferisce alle ulteriori parti installabili sull'apparecchio.
accessories. refers to items that can be added to the light fitting.

1	indice di resa cromatica · colour rendering index
2	indice di resa del rosso · red colour rendering index
3	Rf indice di fedeltà colore · colour fidelity index Rg indice di saturazione colore · color gamut index
4	step di macadam · macadam step
5	corrente di alimentazione · power supply current
6	tensione di alimentazione · power supply voltage
7	flusso luminoso · light flux
8	potenza della sorgente · source power
9	efficienza della sorgente · source efficiency
10	codice sorgente elettronica Viabizzuno · Viabizzuno led source code
11	superficie emittente · light emitting surface (mm)
12	% flusso residuo a fine vita · end life % flux
13	% consentita sotto limite · allowed % under limit

wet prodotto classificato per uso esterno · product classified for outdoor use

damp prodotto classificato per uso interno in ambienti umidi (bagno, sauna, ecc..) · product classified for indoor use in damp environments (bathrooms, saunas, etc.)

dry prodotto classificato per uso interno in ambienti asciutti · product classified for indoor use in dry environments

legenda simboli symbols legenda

 prodotto in conformità con le direttive nord americane sui soffioni doccia · produced in compliance with showerheads northamerican directives

 componente certificato per il mercato nord americano idoneo ad essere utilizzato e valutato come parte di in un sistema più complesso
component approved for north american market and suitable to be used and approved as part of a more complex system

 prodotto finito idoneo per essere commercializzato nel mercato nord americano · listed product suitable for the north american market

 prodotto finito idoneo per essere commercializzato nel mercato nord americano · listed product suitable for the north american market

type ic apparecchio di illuminazione ad incasso progettato per funzionare a contatto con materiale isolante.
recessed luminaire designed to work in contact with thermal insulation.

type non-ic apparecchio di illuminazione ad incasso progettato per funzionare in intercapedini che abbiano una certa distanza da materiali isolanti.
recessed luminaire designed to work in cavities that have a minimum dimensions and spacings to thermal insulation.

title24 prodotto conforme allo standard title24 · product compliant with title24 standard

 vetro opalino · opal glass

 vetro sabbiato · sanded glass

 vetro nero fumè · black smoke glass

 vetro trasparente · transparent glass

 vetro bianco latte · white milk glass

 cristallo · crystal

 policarbonato opalino · opal polycarbonate diffuser

 carrabile · drive over

A alimentatore incluso · power supply included

A alimentatore escluso · power supply not included

AR alimentatore remoto incluso · remote power supply included

Ai alimentatore elettronico con controllo intelligente incluso · electronic power supply with smart control included

AiR alimentatore elettronico con controllo intelligente incluso, da installare remoto · electronic power supply with smart control included, to be installed remotely

AS alimentatore a spina incluso · plug power supply included

T trasformatore incluso · transformer included

K kit di cablaggio incluso · wiring kit not included

K kit di cablaggio escluso · wiring kit not included

L lampadina con sorgente elettronica led, ad incandescenza, alogena o fluorescente inclusa.
bulb with led electronic source, incandescent, halogen or fluorescent included.

L lampadina con sorgente elettronica led, ad incandescenza, alogena o fluorescente esclusa.
bulb with led electronic source, incandescent, halogen or fluorescent not included.

PR propulsore dinamico n55 incluso · included

 attenzione: sorgente luminosa led. non guardare mai direttamente a occhio nudo · attention: led light source. never look straight without eye protection

i peso netto · net weight (kg)

 possibilità di combinazione tra interfaccia n55, propulsore dinamico n55 e lampadina n55 · possible combination between n55 interface, propulsore dinamico n55 and n55 bulb

I.d. luce diretta · direct light

I.i. luce indiretta · indirect light

V  disponibile su · available on *Viabizzuno applight* www.Viabizzuno.com *Viabizzuno online*