



Viabizzuno strada principale della frazione di bizzuno in provincia di ravenna dove tra la casa del popolo e la parrocchia, al n°17, sono nato il ventuno luglio millenovecentocinquantacinque. da qui nasce il nome della fabbrica di produzione fondata nel millenovecentonovantaquattro rappresentata da uno spazio bianco attraversato da due linee. una verticale, rigorosa, essenziale, equilibrata: la luce per la luce; ed una inclinata, irriverente nello spazio, ironica, fuori dagli schemi: la luce per la forma. distinte ma complementari si fondono in un unico nome: Viabizzuno.

marionanni

Viabizzuno is the name of the main road of the small village bizzuno located in the province of ravenna, where I was born on the twenty-first july nineteenfiftyfive at n°17, between the 'casa del popolo' and the local parish church. from here the name of the factory founded in nineteen ninety-four represented by a white space intersected by two lines. one vertical, well balanced, logical, essential: the light for the light. the other one dynamic, irreverent, ironic: the light for the form. separate and yet complementary they cast in the same name: Viabizzuno.

prodotto
product



schede tecniche
technical data sheets



curve fotometriche
photometric curves



modelli 3d per i tuoi render
3d models for your render



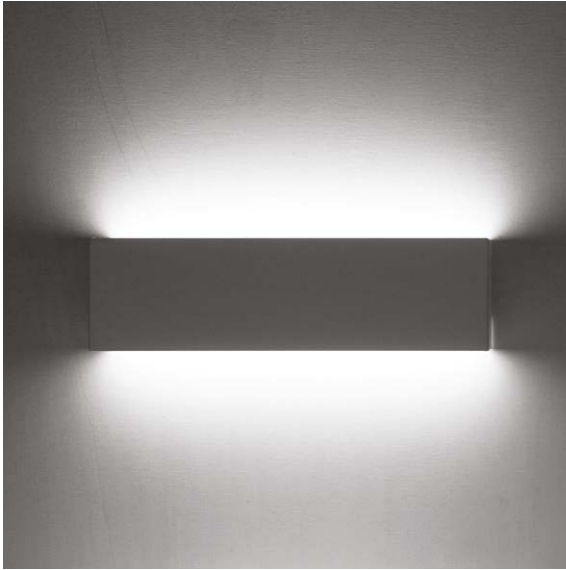

apparecchio di illuminazione da parete per interni. composto da corpo rettangolare, realizzato in alluminio ossidato o verniciato a polvere, completo di diffusore estruso in policarbonato opalino.
modelli:
 net 24 muro 220x70x57mm/8.7x2.8x2.2" 2x5,5W 24Vdc con alimentatore escluso, da installare remoto,
 net 48 muro 480x70x57mm/18.9x2.8x2.2" 2x12,5W,
 net 96 muro 960x70x57mm/37.8x2.8x2.2" 2x24,5W,
 net 192 muro 1920x70x57mm/75.6x2.8x2.2" 2x49,5W.
 alimentatore 120V 50-60Hz incluso.
 cablato con sorgente elettronica 2700K o 3000K Ra95 biemissione.
 finiture: bianco V, argento hacca e marrone mn.

dry location rated wall light fitting for indoor use. consisting of a rectangular fitting, made of oxidised or powder coated aluminium, complete with opal polycarbonate extruded diffuser.
versions:
 net 24 muro 220x70x57mm/8.7x2.8x2.2" 2x5,5W 24Vdc with power supply not included, to be installed remotely,
 net 48 muro 480x70x57mm/18.9x2.8x2.2" 2x12,5W,
 net 96 muro 960x70x57mm/37.8x2.8x2.2" 2x24,5W,
 net 192 muro 1920x70x57mm/75.6x2.8x2.2" 2x49,5W.
 120V 50-60Hz power supply included.
 wired with 2700K or 3000K Ra95 bi-directional led source.
 finishes: bianco V, argento hacca and marrone mn.

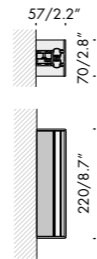

net 24 muro		24Vdc	Ⓜ	dry	⚠	Ⓢ	ⓘ
Vb6.584.01.27.u	bianco V	2700K	2x5,5W	220mm 8.66"	1,7kg 3.7lb		
Vb6.584.06.27.u	argento hacca	2700K	2x5,5W	220mm 8.66"	1,7kg 3.7lb		
Vb6.584.04.27.u	marrone mn	2700K	2x5,5W	220mm 8.66"	1,7kg 3.7lb		

I.d. (luce diretta - direct light)

Ra	R9	ies tm-30		sdcm	V _f	lm/m	W/m	lm/W
95	90	Rf 90	Rg 98	step 2	24	2400	26	92
V3000	11	Ta25 °C		vita media · average life	50000 h	L80	B10	

I.i. (luce indiretta - indirect light)

Ra	R9	ies tm-30		sdcm	V _f	lm/m	W/m	lm/W
95	90	Rf 90	Rg 98	step 2	24	2400	26	92
V3000	11	Ta25 °C		vita media · average life	50000 h	L80	B10	

Vb6.584.01.30.u	bianco V	3000K	2x5,5W	220mm 8.66"	1,7kg 3.7lb		
Vb6.584.06.30.u	argento hacca	3000K	2x5,5W	220mm 8.66"	1,7kg 3.7lb		
Vb6.584.04.30.u	marrone mn	3000K	2x5,5W	220mm 8.66"	1,7kg 3.7lb		

I.d. (luce diretta - direct light)

Ra	R9	ies tm-30		sdcm	V _f	lm/m	W/m	lm/W
95	90	Rf 93	Rg 102	step 2	24	2500	26	96
V3001	11	Ta25 °C		vita media · average life	50000 h	L80	B10	

I.i. (luce indiretta - indirect light)

Ra	R9	ies tm-30		sdcm	V _f	lm/m	W/m	lm/W
95	90	Rf 93	Rg 102	step 2	24	2500	26	96
V3001	11	Ta25 °C		vita media · average life	50000 h	L80	B10	

alimentatori. power supplies.

	120 50-60Hz	Ⓜ	damp	Ⓢ	ⓘ
14.005.1	24V	25W	0,3kg 0.7lb		

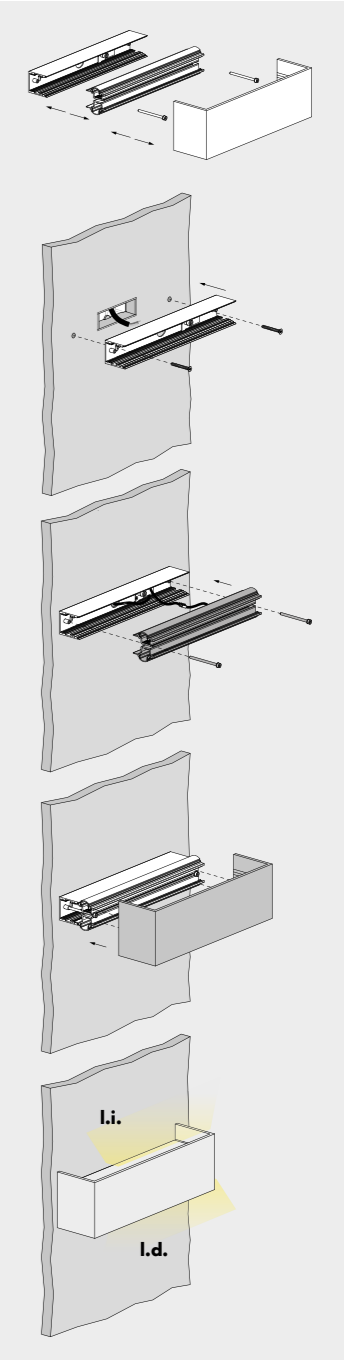
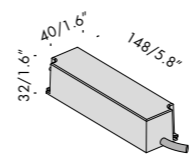

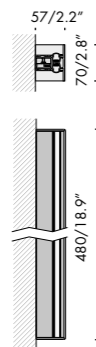

net 48 muro		120V 50-60Hz		dry		A		i	
Vb6.584.11.27.u	bianco V	2700K	2x12,5W	480mm	2,7kg	18.9"	5.9lb		
Vb6.584.16.27.u	argento hacca	2700K	2x12,5W	480mm	2,7kg	18.9"	5.9lb		
Vb6.584.14.27.u	marrone mn	2700K	2x12,5W	480mm	2,7kg	18.9"	5.9lb		

I.d. (luce diretta - direct light)

Ra	R9	ies tm-30		sdcm	V _f	lm/m	W/m	lm/W
95	90	Rf 90	Rg 98	step 2	24	2400	26	92
V3000	11		Ta25 °C		vita media · average life		50000 h	L80 B10

I.i. (luce indiretta - indirect light)

Ra	R9	ies tm-30		sdcm	V _f	lm/m	W/m	lm/W
95	90	Rf 90	Rg 98	step 2	24	2400	26	92
V3000	11		Ta25 °C		vita media · average life		50000 h	L80 B10

Vb6.584.11.30.u	bianco V	3000K	2x12,5W	480mm	2,7kg	18.9"	5.9lb		
Vb6.584.16.30.u	argento hacca	3000K	2x12,5W	480mm	2,7kg	18.9"	5.9lb		
Vb6.584.14.30.u	marrone mn	3000K	2x12,5W	480mm	2,7kg	18.9"	5.9lb		

I.d. (luce diretta - direct light)

Ra	R9	ies tm-30		sdcm	V _f	lm/m	W/m	lm/W
95	90	Rf 93	Rg 102	step 2	24	2500	26	96
V3001	11		Ta25 °C		vita media · average life		50000 h	L80 B10

I.i. (luce indiretta - indirect light)

Ra	R9	ies tm-30		sdcm	V _f	lm/m	W/m	lm/W
95	90	Rf 93	Rg 102	step 2	24	2500	26	96
V3001	11		Ta25 °C		vita media · average life		50000 h	L80 B10

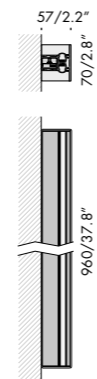

net 96 muro		120V 50-60Hz		dry		A		i	
Vb6.584.21.27.u	bianco V	2700K	2x24,5W	960mm	3,2kg	37.8"	7lb		
Vb6.584.26.27.u	argento hacca	2700K	2x24,5W	960mm	3,2kg	37.8"	7lb		
Vb6.584.24.27.u	marrone mn	2700K	2x24,5W	960mm	3,2kg	37.8"	7lb		

I.d. (luce diretta - direct light)

Ra	R9	ies tm-30		sdcm	V _f	lm/m	W/m	lm/W
95	90	Rf 90	Rg 98	step 2	24	2400	26	92
V3000	11		Ta25 °C		vita media · average life		50000 h	L80 B10

I.i. (luce indiretta - indirect light)

Ra	R9	ies tm-30		sdcm	V _f	lm/m	W/m	lm/W
95	90	Rf 90	Rg 98	step 2	24	2400	26	92
V3000	11		Ta25 °C		vita media · average life		50000 h	L80 B10

Vb6.584.21.30.u	bianco V	3000K	2x24,5W	960mm	3,2kg	37.8"	7lb		
Vb6.584.26.30.u	argento hacca	3000K	2x24,5W	960mm	3,2kg	37.8"	7lb		
Vb6.584.24.30.u	marrone mn	3000K	2x24,5W	960mm	3,2kg	37.8"	7lb		

I.d. (luce diretta - direct light)

Ra	R9	ies tm-30		sdcm	V _f	lm/m	W/m	lm/W
95	90	Rf 93	Rg 102	step 2	24	2500	26	96
V3001	11		Ta25 °C		vita media · average life		50000 h	L80 B10

I.i. (luce indiretta - indirect light)

Ra	R9	ies tm-30		sdcm	V _f	lm/m	W/m	lm/W
95	90	Rf 93	Rg 102	step 2	24	2500	26	96
V3001	11		Ta25 °C		vita media · average life		50000 h	L80 B10

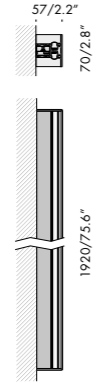

net 192 muro 120V 50-60Hz **A** dry

- Vb6.584.31.27.u** bianco V 2700K 2x49,5W 1920mm 4,8kg
75.5" 10.5lb
- Vb6.584.36.27.u** argento hacca 2700K 2x49,5W 1920mm 4,8kg
75.5" 10.5lb
- Vb6.584.34.27.u** marrone mn 2700K 2x49,5W 1920mm 4,8kg
75.5" 10.5lb

I.d. (luce diretta - direct light)

Ra	R9	ies tm-30		sdcm	V _f	lm/m	W/m	lm/W
95	90	Rf 90	Rg 98	step 2	24	2400	26	92
V3000	11		Ta25 °C	vita media · average life		50000 h	L80	B10

I.i. (luce indiretta - indirect light)

Ra	R9	ies tm-30		sdcm	V _f	lm/m	W/m	lm/W
95	90	Rf 90	Rg 98	step 2	24	2400	26	92
V3000	11		Ta25 °C	vita media · average life		50000 h	L80	B10

- Vb6.584.31.30.u** bianco V 3000K 2x49,5W 1920mm 4,8kg
75.5" 10.5lb
- Vb6.584.36.30.u** argento hacca 3000K 2x49,5W 1920mm 4,8kg
75.5" 10.5lb
- Vb6.584.34.30.u** marrone mn 3000K 2x49,5W 1920mm 4,8kg
75.5" 10.5lb

I.d. (luce diretta - direct light)

Ra	R9	ies tm-30		sdcm	V _f	lm/m	W/m	lm/W
95	90	Rf 93	Rg 102	step 2	24	2500	26	96
V3001	11		Ta25 °C	vita media · average life		50000 h	L80	B10

I.i. (luce indiretta - indirect light)

Ra	R9	ies tm-30		sdcm	V _f	lm/m	W/m	lm/W
95	90	Rf 93	Rg 102	step 2	24	2500	26	96
V3001	11		Ta25 °C	vita media · average life		50000 h	L80	B10

copertura per outlet box. cover for outlet box.

- Vb9.000.02.u** scomparsa totale cartongesso 0,3kg
fully concealed for plasterboard installation 0.7lb

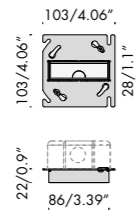

lettura delle tabelle tecniche how to read technical tables

xxxxxxxxxxxxxxxx							120V 50-60Hz	A	wet	UL	UL	UL	i
a	b	c	d	e	f	f	g						

xxxxxxxxxxxxxxxx							120V 50-60Hz	A	wet	UL	UL	UL	i
Vbx.xxx.xx	nero55	3000K	35W	20°	0,8kg	1.8lb							
h	i	l	m	n	g								

componenti. components.

accessori. accessories.

1	2	3	4	5	6	7	8	9	
Ra	R9	ies tm-30		sdc	mA	V _{f (min)}	lm	W	lm/W
98	98	Rf 96	Rg 103	step 1	350	27,6	1240	9,7	128
					500	27,9	1580	14,0	113
xm000	les19	Ta25 °C		vita media · average life		50000 h	L80	B10	
10	11							12	13

classificazione ambiente di installazione installation location rating

bandella tecnica. posizioni standard simbologie.
data plate. standard arrangement of symbols.

a	nome apparecchio di illuminazione · light fitting name
b	tensione di alimentazione · supply rating (Volt)
c	frequenza di alimentazione · supply frequency (Hertz)
d	alimentatore incluso o escluso · power supply included or not included
e	classificazione ambiente di installazione · installation location rating
f	marchio di certificazione · safety and quality standards certification
g	peso netto · net weight (kg/lb)
h	codice · code
i	finiture · colours and finishes
l	temperatura colore sorgente elettronica colour temperature led source (Kelvin)
m	potenza della sorgente · source power (Watt)
n	gradi fascio luminoso · light beam degrees

componenti. identifica tutti gli elementi indispensabili per la corretta funzionalità e installazione dell'apparecchio di illuminazione.
components. includes all items that are essential to the correct operation and installation of the light fitting.

accessori. si riferisce alle ulteriori parti installabili sull'apparecchio.
accessories. refers to items that can be added to the light fitting.

1	indice di resa cromatica · colour rendering index
2	indice di resa del rosso · red colour rendering index
3	Rf indice di fedeltà colore · colour fidelity index Rg indice di saturazione colore · color gamut index
4	step di macadam · macadam step
5	corrente di alimentazione · power supply current
6	tensione di alimentazione · power supply voltage
7	flusso luminoso · light flux
8	potenza della sorgente · source power
9	efficienza della sorgente · source efficiency
10	codice sorgente elettronica Viabizzuno · Viabizzuno led source code
11	superficie emittente · light emitting surface (mm)
12	% flusso residuo a fine vita · end life % flux
13	% consentita sotto limite · allowed % under limit

wet prodotto classificato per uso esterno · product classified for outdoor use

damp prodotto classificato per uso interno in ambienti umidi (bagno, sauna, ecc..) · product classified for indoor use in damp environments (bathrooms, saunas, etc.)

dry prodotto classificato per uso interno in ambienti asciutti · product classified for indoor use in dry environments

legenda simboli symbols legenda

 prodotto in conformità con le direttive nord americane sui soffioni doccia · produced in compliance with showerheads northamerican directives

 componente certificato per il mercato nord americano idoneo ad essere utilizzato e valutato come parte di in un sistema più complesso
component approved for north american market and suitable to be used and approved as part of a more complex system

 prodotto finito idoneo per essere commercializzato nel mercato nord americano · listed product suitable for the north american market

 prodotto finito idoneo per essere commercializzato nel mercato nord americano · listed product suitable for the north american market

type ic apparecchio di illuminazione ad incasso progettato per funzionare a contatto con materiale isolante.
recessed luminaire designed to work in contact with thermal insulation.

type non-ic apparecchio di illuminazione ad incasso progettato per funzionare in intercapedini che abbiano una certa distanza da materiali isolanti.
recessed luminaire designed to work in cavities that have a minimum dimensions and spacings to thermal insulation.

title24 prodotto conforme allo standard title24 · product compliant with title24 standard

 vetro opalino · opal glass

 vetro sabbiato · sanded glass

 vetro nero fumè · black smoke glass

 vetro trasparente · transparent glass

 vetro bianco latte · white milk glass

 cristallo · crystal

 policarbonato opalino · opal polycarbonate diffuser

 carrabile · drive over

A alimentatore incluso · power supply included

A alimentatore escluso · power supply not included

AR alimentatore remoto incluso · remote power supply included

Ai alimentatore elettronico con controllo intelligente incluso · electronic power supply with smart control included

AiR alimentatore elettronico con controllo intelligente incluso, da installare remoto · electronic power supply with smart control included, to be installed remotely

AS alimentatore a spina incluso · plug power supply included

T trasformatore incluso · transformer included

K kit di cablaggio incluso · wiring kit not included

K kit di cablaggio escluso · wiring kit not included

L lampadina con sorgente elettronica led, ad incandescenza, alogena o fluorescente inclusa.
bulb with led electronic source, incandescent, halogen or fluorescent included.

L lampadina con sorgente elettronica led, ad incandescenza, alogena o fluorescente esclusa.
bulb with led electronic source, incandescent, halogen or fluorescent not included.

PR propulsore dinamico n55 incluso · included

 attenzione: sorgente luminosa led. non guardare mai direttamente a occhio nudo · attention: led light source. never look straight without eye protection

i peso netto · net weight (kg)

 possibilità di combinazione tra interfaccia n55, propulsore dinamico n55 e lampadina n55 · possible combination between n55 interface, propulsore dinamico n55 and n55 bulb

I.d. luce diretta · direct light

I.i. luce indiretta · indirect light

V  disponibile su · available on *Viabizzuno applight* www.Viabizzuno.com *Viabizzuno online*