



Viabizzuno strada principale della frazione di bizzuno in provincia di ravenna dove tra la casa del popolo e la parrocchia, al n°17, sono nato il ventuno luglio millenovecentocinquantacinque. da qui nasce il nome della fabbrica di produzione fondata nel millenovecentonovantaquattro rappresentata da uno spazio bianco attraversato da due linee. una verticale, rigorosa, essenziale, equilibrata: la luce per la luce; ed una inclinata, irriverente nello spazio, ironica, fuori dagli schemi: la luce per la forma. distinte ma complementari si fondono in un unico nome: Viabizzuno.

marionanni

Viabizzuno is the name of the main road of the small village bizzuno located in the province of ravenna, where I was born on the twenty-first july nineteenfiftyfive at n°17, between the 'casa del popolo' and the local parish church. from here the name of the factory founded in nineteen ninety-four represented by a white space intersected by two lines. one vertical, well balanced, logical, essential: the light for the light. the other one dynamic, irreverent, ironic: the light for the form. separate and yet complementary they cast in the same name: Viabizzuno.

prodotto
product



schede tecniche
data sheets



curve fotometriche
photometric curves



modelli 3d per i tuoi render
3d models for your render





apparecchio di illuminazione da incasso per interni.
realizzato in alluminio verniciato con vetro diametro Ø54mm/2.1" h.75mm/2.9".
modelli:
royal incasso 01 con vetro trasparente aperto,
royal incasso 02 vetro trasparente con cono in ottone,
royal incasso 03 vetro sabbiato chiuso con porzione inferiore concava.
cablato con sorgente elettronica 3000K Ra98 fino a 14W 1580lm.
alimentatore in corrente costante escluso, da installare remoto.
eventuali irregolarità del vetro sono garanzia di un prodotto unico, soffiato e realizzato
interamente a mano da maestri vetrai.
finiture: my bianco, nero55 e copper bronze.

recessed light fitting for indoor use.
made of painted aluminium with glass diameter Ø54mm/2.1" h.75mm/2.9".
versions:
royal incasso 01 with open transparent glass,
royal incasso 02 with transparent glass and brass cone,
royal incasso 03 closed sanded glass with concave lower side.
wired with 3000K Ra98 led source up to 14W 1580lm.
constant current power supply not included, to be installed remotely.
any irregularities in the glass are a guarantee of an unique product, blown and entirely
hand crafted by master glassmakers.
finishes: my bianco, nero55 and copper bronze.

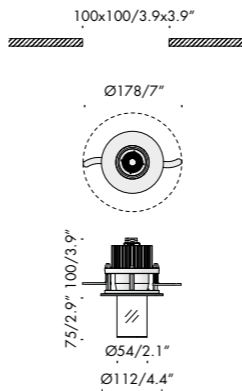

royal incasso 01		type non-ic	damp	i
Vb6.574.06.u	my bianco	trasparente · transparent	3000K	1,1kg 2.4b
Vb6.574.07.u	nero55	trasparente · transparent	3000K	1,1kg 2.4b
Vb6.574.08.u	copper bronze	trasparente · transparent	3000K	1,1kg 2.4b

Ra	R9	ies tm-30	sdc	mA	V _{f (min)}	lm	W	lm/W	
98	98	Rf 96	Rg 103	step 1	500	27,9	1580	14,0	113
xm001	les19	● Ta25 °C	vita media · average life	70000 h	L80	B10			

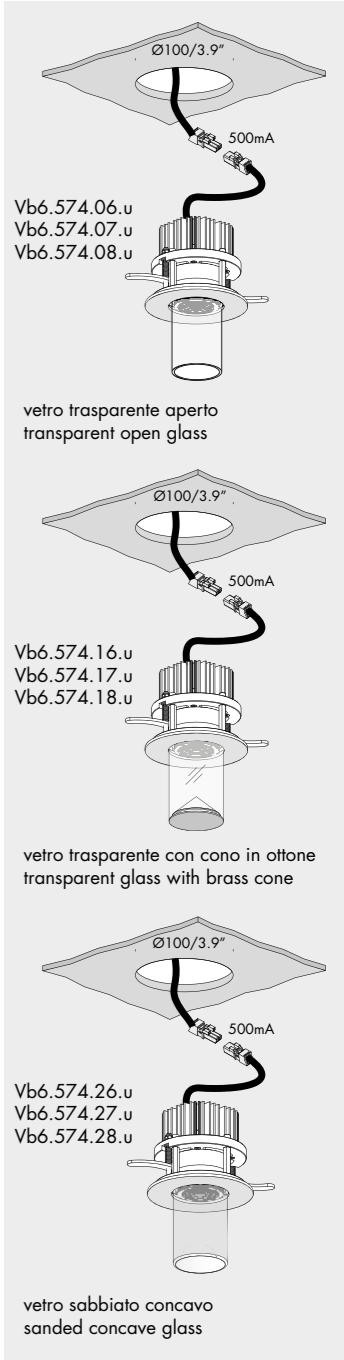

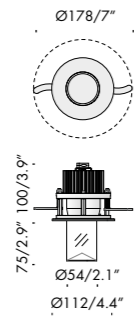

royal incasso 02			type non-ic	damp		
Vb6.574.16.u	my bianco	trasparente · transparent	3000K	1,1kg 2.4b		
Vb6.574.17.u	nero55	trasparente · transparent	3000K	1,1kg 2.4b		
Vb6.574.18.u	copper bronze	trasparente · transparent	3000K	1,1kg 2.4b		

Ra	R9	ies tm-30		sdcm	mA	V _f (min)	lm	W	lm/W
98	98	Rf 96	Rg 103	step 1	500	27,9	1580	14,0	113
xm001	les19	Ta25 °C		vita media · average life		70000 h	L80	B10	



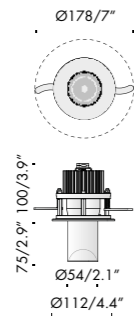

royal incasso 03			type non-ic	damp		i
Vb6.574.26.u	my bianco	sabbiato · sanded	3000K	1,1kg 2.4b		
Vb6.574.27.u	nero55	sabbiato · sanded	3000K	1,1kg 2.4b		
Vb6.574.28.u	copper bronze	sabbiato · sanded	3000K	1,1kg 2.4b		

Ra	R9	ies tm-30		sdc	mA	V _{f (min)}	lm	W	lm/W
98	98	Rf 96	Rg 103	step 1	500	27,9	1580	14,0	113
xm001	les19	Ta25 °C		vita media · average life		70000 h	L80	B10	

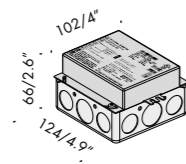

alimentatori. power supplies.		120V 50-60Hz		dry		i
t4.620.u	350mA	15÷38V	13W	0,9kg 1.9lb		
t4.621.u	500mA	15÷38V	19W	0,9kg 1.9lb		



lettura delle tabelle tecniche how to read technical tables

xxxxxxxxxxxxxxxx				120V 50-60Hz	A	wet	UL	UL US	i
a	b	c	d	e	f	f	g		

xxxxxxxxxxxxxxxx				120V 50-60Hz	A	wet	UL	UL US	i
Vbx.xxx.xx	nero55	3000K	35W	20°	0,8kg	1.8lb			
h	i	l	m	n	g				

componenti. components.

accessori. accessories.

1	2	3	4	5	6	7	8	9	
Ra	R9	ies tm-30		sdc	mA	V _{f (min)}	lm	W	lm/W
98	98	Rf 96	Rg 103	step 1	350	27,6	1240	9,7	128
					500	27,9	1580	14,0	113
xm000	les19	Ta25 °C		vita media · average life		50000 h	L80	B10	
10	11						12	13	

classificazione ambiente di installazione installation location rating

bandella tecnica. posizioni standard simbologie.
data plate. standard arrangement of symbols.

a	nome apparecchio di illuminazione · light fitting name
b	tensione di alimentazione · supply rating (Volt)
c	frequenza di alimentazione · supply frequency (Hertz)
d	alimentatore incluso o escluso · power supply included or not included
e	classificazione ambiente di installazione · installation location rating
f	marchio di certificazione · safety and quality standards certification
g	peso netto · net weight (kg/lb)
h	codice · code
i	finiture · colours and finishes
l	temperatura colore sorgente elettronica colour temperature led source (Kelvin)
m	potenza della sorgente · source power (Watt)
n	gradi fascio luminoso · light beam degrees

componenti. identifica tutti gli elementi indispensabili per la corretta funzionalità e installazione dell'apparecchio di illuminazione.
components. includes all items that are essential to the correct operation and installation of the light fitting.

accessori. si riferisce alle ulteriori parti installabili sull'apparecchio.
accessories. refers to items that can be added to the light fitting.

1	indice di resa cromatica · colour rendering index
2	indice di resa del rosso · red colour rendering index
3	Rf indice di fedeltà colore · colour fidelity index Rg indice di saturazione colore · color gamut index
4	step di macadam · macadam step
5	corrente di alimentazione · power supply current
6	tensione di alimentazione · power supply voltage
7	flusso luminoso · light flux
8	potenza della sorgente · source power
9	efficienza della sorgente · source efficiency
10	codice sorgente elettronica Viabizzuno · Viabizzuno led source code
11	superficie emittente · light emitting surface (mm)
12	% flusso residuo a fine vita · end life % flux
13	% consentita sotto limite · allowed % under limit

wet prodotto classificato per uso esterno · product classified for outdoor use

damp prodotto classificato per uso interno in ambienti umidi (bagno, sauna, ecc..) · product classified for indoor use in damp environments (bathrooms, saunas, etc.)

dry prodotto classificato per uso interno in ambienti asciutti · product classified for indoor use in dry environments

legenda simboli symbols legenda

 prodotto in conformità con le direttive nord americane sui soffioni doccia · produced in compliance with showerheads northamerican directives

 componente certificato per il mercato nord americano idoneo ad essere utilizzato e valutato come parte di in un sistema più complesso
component approved for north american market and suitable to be used and approved as part of a more complex system

 prodotto finito idoneo per essere commercializzato nel mercato nord americano · listed product suitable for the north american market

 prodotto finito idoneo per essere commercializzato nel mercato nord americano · listed product suitable for the north american market

type ic apparecchio di illuminazione ad incasso progettato per funzionare a contatto con materiale isolante.
recessed luminaire designed to work in contact with thermal insulation.

type non-ic apparecchio di illuminazione ad incasso progettato per funzionare in intercapedini che abbiano una certa distanza da materiali isolanti.
recessed luminaire designed to work in cavities that have a minimum dimensions and spacings to thermal insulation.

title24 prodotto conforme allo standard title24 · product compliant with title24 standard

 vetro opalino · opal glass

 vetro sabbiato · sanded glass

 vetro nero fumè · black smoke glass

 vetro trasparente · transparent glass

 vetro bianco latte · white milk glass

 cristallo · crystal

 policarbonato opalino · opal polycarbonate diffuser

 carrabile · drive over

A alimentatore incluso · power supply included

A alimentatore escluso · power supply not included

AR alimentatore remoto incluso · remote power supply included

Ai alimentatore elettronico con controllo intelligente incluso · electronic power supply with smart control included

AiR alimentatore elettronico con controllo intelligente incluso, da installare remoto · electronic power supply with smart control included, to be installed remotely

AS alimentatore a spina incluso · plug power supply included

T trasformatore incluso · transformer included

K kit di cablaggio incluso · wiring kit not included

K kit di cablaggio escluso · wiring kit not included

L lampadina con sorgente elettronica led, ad incandescenza, alogena o fluorescente inclusa.
bulb with led electronic source, incandescent, halogen or fluorescent included.

L lampadina con sorgente elettronica led, ad incandescenza, alogena o fluorescente esclusa.
bulb with led electronic source, incandescent, halogen or fluorescent not included.

PR propulsore dinamico n55 incluso · included

 attenzione: sorgente luminosa led. non guardare mai direttamente a occhio nudo · attention: led light source. never look straight without eye protection

i peso netto · net weight (kg)

 possibilità di combinazione tra interfaccia n55, propulsore dinamico n55 e lampadina n55 · possible combination between n55 interface, propulsore dinamico n55 and n55 bulb

I.d. luce diretta · direct light

I.i. luce indiretta · indirect light

V  disponibile su · available on *Viabizzuno applight* www.Viabizzuno.com *Viabizzuno online*