

*Viabizzuno strada principale della frazione di bizzuno in provincia di ravenna dove tra la casa del popolo e la parrocchia, al n°17, sono nato il ventuno luglio millenovecentocinquantacinque. da qui nasce il nome della fabbrica di produzione fondata nel millenovecentonovantaquattro rappresentata da uno spazio bianco attraversato da due linee. una verticale, rigorosa, essenziale, equilibrata: la luce per la luce; ed una inclinata, irriverente nello spazio, ironica, fuori dagli schemi: la luce per la forma. distinte ma complementari si fondono in un unico nome: Viabizzuno.*

Viabizzuno is the name of the main road of the small village bizzuno located in the province of ravenna, where I was born on the twenty-first july nineteenfiftyfive at n°17, between the 'casa del popolo' and the local parish church. from here the name of the factory founded in nineteen ninety-four represented by a white space intersected by two lines. one vertical, well balanced, logical, essential: the light for the light. the other one dynamic, irreverent, ironic: the light for the form. separate and yet complementary they cast in the same name: Viabizzuno. marionanni

*i progetti rendono gli oggetti eterni,  
le mode li corrompono, gli imbecilli li copiano  
e li vendono agli ignoranti e ai deficienti.  
noi progettiamo e lavoriamo per aiutare la luce  
ad emozionarvi.*

*i frutti delle nostre idee e dei nostri progetti  
sono protetti da brevetti  
e/o modelli registrati  
e/o da diritto d'autore.*

*design makes objects timeless,  
fashion corrupts them,  
fools copy them and sell them to  
ignorants and idiots.  
we do projects and work to help light to bring  
you true emotion.  
the results of our ideas and our projects  
are protected by patents  
and/or registered models  
and/or copyright.*

*al fine di offrire ai nostri clienti la massima qualità della luce utilizzando le più avanzate tecnologie, forti del nostro sapere artigiano costruito in italia, aggiorniamo costantemente i nostri apparecchi di illuminazione.*

*Viabizzuno si riserva il diritto di apportare ai propri modelli, senza nessun preavviso, qualsiasi modifica ritenesse opportuna. per dimensioni e codici fanno fede i nostri strumenti di lavoro [www.Viabizzuno.com](http://www.Viabizzuno.com), [Viacommerce@](mailto:Viacommerce@viabizzuno.com), [Viabizzunoapplight](http://Viabizzunoapplight.com) e [Viabizzunoonline](http://Viabizzunoonline.com).*

*in order to provide to our customers the maximum quality of light using the most advanced technologies, being strong of our artisan knowledge made in italy, we constantly update our lighting fixtures.*

*Viabizzuno reserves the right to make any modification, considered worthwhile, to its own models, without any notification. for valid dimensions and codes please consult our working tools [www.Viabizzuno.com](http://www.Viabizzuno.com), [Viacommerce@](mailto:Viacommerce@viabizzuno.com), [Viabizzunoapplight](http://Viabizzunoapplight.com) and [Viabizzunoonline](http://Viabizzunoonline.com).*

# lettura delle tabelle tecniche how to read technical tables

XXXXXXXXXXXXXXXXXX										
230V 50-60Hz				A	⊕	IP66		US	CE	
a	b	c	d	e	f	g	g	h	i	

XXXXXXXXXXXXXXXXXX										
230V 50-60Hz				A	⊕	IP66		US	CE	
Vbx.xxx.xx	nero55	3000K		35W	1,5					
l	m	n	o	i						

<b>componenti. components.</b>	IK10	CE	
--------------------------------	------	----	--

<b>accessori. accessories.</b>	IK10	CE	
--------------------------------	------	----	--

1	2	3	4	5	6	7	8	9	10
---	---	---	---	---	---	---	---	---	----

Ra	R9	ies tm/30		sdcM	Vf	lm/m	W/m	lm/W	
95	90	Rf 90	Rg 98	step 2	24	1200	13	92	F
V0000	5,9		Ta25 °C	vita media · average life	50000 h	L80	B10		

11	12	13	14
----	----	----	----

bandella tecnica. posizioni standard simbologie.  
data plate. standard arrangement of symbols.

a	nome apparecchio di illuminazione · light fitting name
b	tensione di alimentazione · supply rating (Volt)
c	frequenza di alimentazione · supply frequency (Hertz)
d	alimentatore incluso o escluso · power supply included or not included
e	classe di isolamento · insulation class
f	grado di protezione · protection degree
g	marchio di certificazione · safety and quality standards certification
h	conforme alle direttive europee produced in compliance with EC directives
i	peso netto · net weight (kg)
l	codice · code
m	finitura · finish
n	temperatura colore sorgente elettronica colour temperature led source (Kelvin)
o	potenza della sorgente · source power (Watt)

componenti. identifica tutti gli elementi indispensabili per la corretta funzionalità e installazione dell'apparecchio di illuminazione.  
components. includes all items that are essential to the correct operation and installation of the light fitting.















accessori. si riferisce alle ulteriori parti installabili sull'apparecchio.  
accessories. refers to items that can be added to the light fitting.

1	indice di resa cromatica · colour rendering index
2	indice di resa del rosso · red colour rendering index
3	Rf indice di fedeltà colore · colour fidelity index Rg indice di saturazione colore · color gamut index
4	step di macadam · macadam step
5	corrente di alimentazione · power supply current
6	tensione di alimentazione · power supply voltage
7	flusso luminoso · light flux
8	potenza della sorgente · source power
9	efficienza della sorgente · source efficiency
10	classe di efficienza energetica · efficiency class
11	codice sorgente elettronica Viabizzuno · Viabizzuno led source code
12	superficie emittente · light emitting surface (mm)
13	% flusso residuo a fine vita · end life % flux
14	% consentita sotto limite · allowed % under limit

## gradi di protezione protection degrees

IP0X	<i>non protetto</i> no protection	IPX0	<i>non protetto</i> no protection	IK01	<i>nessuna protezione</i> no protection
IP1X	<i>contro corpi estranei &gt;50 mm</i> protection against solid objects	IPX1	<i>protetto contro la caduta verticale di gocce d'acqua</i> protected against water drops falling vertically	IK01	<i>protetto contro l'energia d'urto 0,15J</i> protected against collision energy
IP2X	<i>contro corpi estranei &gt;12 mm</i> protection against solid objects	IPX2	<i>protetto contro la caduta di gocce con inclinazione max 15°</i> protected against water drops max inclination 15°	IK02	<i>protetto contro l'energia d'urto 0,2J</i> protected against collision energy
IP3X	<i>contro corpi estranei &gt;2,5 mm</i> protection against solid objects	IPX3	<i>protetto contro la caduta di gocce con inclinazione max 60°</i> protected against water drops max inclination 60°	IK03	<i>protetto contro l'energia d'urto 0,35J</i> protected against collision energy
IP4X	<i>contro corpi estranei &gt;1 mm</i> protection against solid objects	IPX4	<i>protetto contro spruzzi d'acqua</i> protected against sprinkling water	IK04	<i>protetto contro l'energia d'urto 0,5J</i> protected against collision energy
IP5X	<i>protezione da polvere</i> dust-protected	IPX5	<i>protetto contro getti d'acqua</i> protected against water jets	IK05	<i>protetto contro l'energia d'urto 0,7J</i> protected against collision energy
IP6X	<i>stagno alla polvere</i> dust-proof	IPX6	<i>protetto contro inondazioni</i> protected against flooding	IK06	<i>protetto contro l'energia d'urto 1J</i> protected against collision energy
		IPX7	<i>per breve immersione</i> protected against brief immersions	IK07	<i>protetto contro l'energia d'urto 2J</i> protected against collision energy
		IPX8	<i>per immersione prolungata</i> protected against long immersion	IK08	<i>protetto contro l'energia d'urto 5J</i> protected against collision energy
				IK09	<i>protetto contro l'energia d'urto 10J</i> protected against collision energy
				IK10	<i>protetto contro l'energia d'urto 20J</i> protected against collision energy

## legenda simboli symbols key

-  tavolo · table
-  terra · floor standing
-  soffitto · ceiling
-  parete · wall
-  sospensione · suspension
-  binario · track
-  incasso · recessed
-  scomparsa totale · fully concealed
-  segnaletica+emergenza · signalling system+emergency
-  portatili autoalimentati a batteria · portable self-powered with battery
-  sistemi · systems
-  palo · pole
-  paletto · bollard
-  seduta · sitting

 disponibile su · available on [Viabizzuno apflight](http://Viabizzuno.aplight.com) [www.Viabizzuno.com](http://www.Viabizzuno.com) [Viabizzuno online](http://Viabizzuno.online)

 classe I. solo isolamento fondamentale, le parti conduttrici accessibili sono collegate ad un conduttore di terra. messa a terra tassativa  
class I. only basic insulation, accessible conductors are earthed. earthing compulsory

 classe II. all'isolamento principale è aggiunto un secondo isolamento oppure ai due isolamenti è sostituito un isolamento rinforzato. messa a terra esclusa  
class II. basic insulation plus second insulation or both are replaced by reinforced insulation. earthing excluded

 classe III. alimentazione effettuata con bassissima tensione di sicurezza; sono escluse tensioni superiori a 50V-50Hz. messa a terra non prevista.  
class III. very low safety supply tension; not to be used over 50V-50Hz. earthing excluded.

 prodotto conforme alle direttive europee · produced in compliance with ec directives

 marchio di certificazione europea. certifica che il prodotto è conforme alle norme europee sulla sicurezza  
component approved for north american market and suitable to be used and approved as part of a more complex system

 componente certificato per il mercato nord americano idoneo ad essere utilizzato e valutato come parte di in un sistema più complesso  
component approved for north american market and suitable to be used and approved as part of a more complex system

 apparecchio di illuminazione approvato da kema · kema approved light fitting

 prodotto conforme agli standard presenti nel regno unito che regolamentano la sicurezza e la qualità dell'acqua · product complies with uk standards set out by water regulations

 apparecchio di illuminazione certificato secondo le normative vigenti in polonia che regolamentano i dispositivi di sicurezza antincendio  
certified light fitting according to the regulations about devices for fire safety in force in poland

 prodotto idoneo per essere commercializzato nel mercato cinese · product suitable for the china market

 prodotto finito idoneo per essere commercializzato nel mercato nord americano · listed product suitable for the north american market

 prodotto conforme alla legislazione vigente nel regno unito · produced in compliance with UK legislation

 apparecchio di illuminazione certificato per il mercato cinese  
light fitting certified for china market

-  *vetro opalino* · opal glass
-  *vetro sabbiato* · sanded glass
-  *vetro nero fumè* · black smoke glass
-  *vetro trasparente* · transparent glass
-  *vetro bianco latte* · white milk glass
-  *crystallo* · crystal
-  *policarbonato opalino* · opal polycarbonate diffuser
-  *carrabile* · drive over
-  *alimentatore incluso* · power supply included
-  *alimentatore escluso* · power supply not included
-  *alimentatore remoto incluso* · remote power supply included
-  *alimentatore elettronico con controllo intelligente incluso* · electronic power supply with smart control included
-  *alimentatore elettronico con controllo intelligente incluso, da installare remoto* · electronic power supply with smart control included, to be installed remotely
-  *alimentatore a spina incluso* · plug power supply included
-  *trasformatore incluso* · transformer included
-  *trasformatore escluso* · transformer not included
-  *kit di cablaggio* · wiring kit
-  *kit di cablaggio escluso* · wiring kit not included
-  *lampadina con sorgente elettronica led, ad incandescenza, alogena o fluorescente inclusa.*  
bulb with led electronic source, incandescent, halogen or fluorescent included.
-  *lampadina con sorgente elettronica led, ad incandescenza, alogena o fluorescente esclusa.*  
bulb with led electronic source, incandescent, halogen or fluorescent not included.
-  *propulsore dinamico n55 incluso* · included
-  *possibilità di combinazione tra interfaccia n55, propulsore dinamico n55 e lampadina n55* · possible combination between n55 interface, propulsore dinamico n55 and n55 bulb
-  *attenzione: sorgente luminosa led. non guardare mai direttamente a occhio nudo* · attention: led light source. never look straight without eye protection
-  *ff flicker free compatibile con fotocamere digitali* · flicker free digital camera friendly
- l.d.** *luce diretta* · direct light
- l.i.** *luce indiretta* · indirect light
- .d1** *dimmerazione 1-10V* · 1-10V dimmable
- .d2** *dimmerazione dali* · dimmable dali
- .SA** *kit luce + emergenza sempre accese. attenzione: non è possibile installare nelle cassaforme laterizio*  
light kit + permanently lit emergency lamp. please note: cannot be installed in brickwork housing
- .SE** *solo emergenza sempre accesa. attenzione: non è possibile installare nelle cassaforme laterizio*  
permanently lit emergency lamp only. please note: cannot be installed in brickwork housing
-  *peso netto* · net weight (kg)

# 13° angolo mario nanni alessandro fantetti 2014

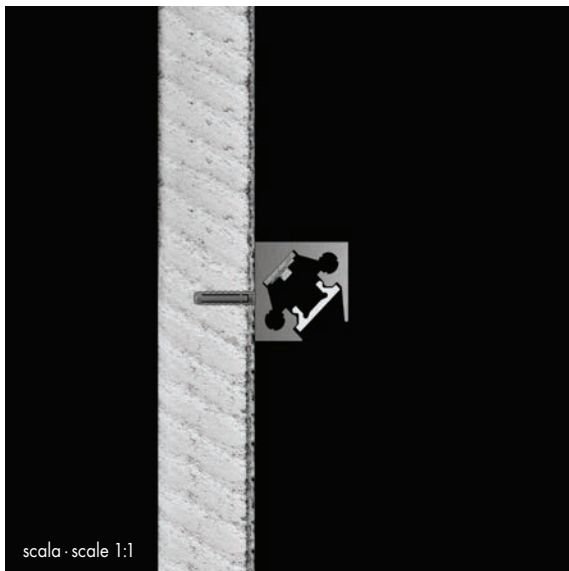

*apparecchio di illuminazione da soffitto, parete, tavolo, terra e sospensione per interni IP20. realizzato in estruso di alluminio ossidato di sezione 13x13mm. composto da profili ciechi o chiusi a 45° da un diffusore estruso in policarbonato satinato della stessa lunghezza del profilo con aletta antiabbagliamento 4mm.*

*modelli:*

*13° angolo 500mm, 1000mm, 2000mm o 3000mm fino a 39W 3744lm,*

*13° angolo 01 210x297x630mm, 22,5W 2160lm,*

*13° angolo 02 210x297x1050mm, 33W 3168lm,*

*13° angolo 03 210x297x1864mm, 47W 9600lm,*

*13° angolo sospensione 210x297x1864mm, 96W 9600lm, sospeso tramite otto cavi di acciaio 3000mm.*

*cablato con sorgente elettronica lineare con limitatore di corrente integrato 3000K Ra95 13W/m.*

*alimentatore in tensione costante 24Vdc escluso, da installare remoto in modello 13° angolo e 13° angolo sospensione, alimentatore a spina in modelli 13° angolo 01, 13° angolo 02 e 13° angolo 03.*

*accessori: ripiani, campane in vetro e, solo per modello 13° angolo sospensione, rosoni di alimentazione, cassafornata scomparsa totale laterizio e cartongesso per cavo di alimentazione e rosoni con alimentatore 220-240V 50Hz.*

*finiture: acciaio acciaio e nero55.*

*personalizza la tua luce vai su [www.Viabizzuno.com](http://www.Viabizzuno.com)*



*IP20 rated ceiling, wall, table, floor standing and suspension light fitting for indoor use. made of extruded oxidised aluminium with a 13x13mm square section.*

*consisting of blind profiles or closed ones at 45° by an extruded frosted polycarbonate diffuser the same length as the profile with 4mm long anti-glare louvre.*

*versions:*

*13° angolo 500mm, 1000mm, 2000mm or 3000mm up to 39W 3744lm,*

*13° angolo 01 210x297x630mm, 22,5W 2160lm,*

*13° angolo 02 210x297x1050mm, 33W 3168lm,*

*13° angolo 03 210x297x1864mm, 47W 9600lm,*

*13° angolo sospensione 210x297x1864mm, 96W 9600lm, suspended by eight 3000mm steel cables.*

*wired with a linear 3000K Ra95 13W/m led source with integrated current limiter.*

*24Vdc constant voltage power supply not included, to be installed remotely for 13° angolo and 13° angolo sospensione versions, power supply with plugs for 13° angolo 01,*

*13° angolo 02 and 13° angolo 03 versions.*

*accessories: shelves, glass bells and, only for 13° angolo sospensione version, power supply roses, plasterboard and brickwork fully concealed housing for power supply cable and rose with 220-240V 50Hz power supply only.*

*finishes: acciaio acciaio and nero55.*

*customize your light visit [www.Viabizzuno.com](http://www.Viabizzuno.com)*





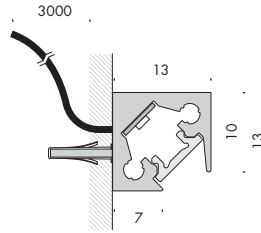

13° angolo		24Vdc				
<b>Vb6.583.01.1</b>	acciaio acciaio	3000K	6,5W	500mm	0,1	
<b>Vb6.583.02</b>	nero55	3000K	6,5W	500mm	0,1	
<b>Vb6.583.11.1</b>	acciaio acciaio	3000K	13W	1000mm	0,2	
<b>Vb6.583.12</b>	nero55	3000K	13W	1000mm	0,2	
<b>Vb6.583.21.1</b>	acciaio acciaio	3000K	26W	2000mm	0,4	
<b>Vb6.583.22</b>	nero55	3000K	26W	2000mm	0,4	
<b>Vb6.583.31.1</b>	acciaio acciaio	3000K	39W	3000mm	0,5	
<b>Vb6.583.32</b>	nero55	3000K	39W	3000mm	0,5	

Ra	R9	ies tm/30		sdc	Vf	lm/m	W/m	lm/W
95	90	Rf 93	Rg 102	step 2	24	1250	13	96
V0001	5,9	Ta25 °C		vita media · average life		50000 h	L80	B10

interasse fori di installazione  
installation hole centres

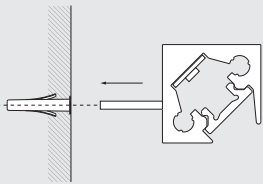

Vb6.583.01.1  
Vb6.583.02

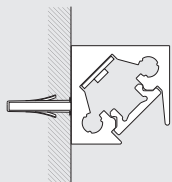
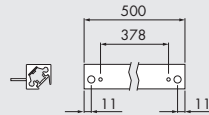

Vb6.583.11.1  
Vb6.583.12

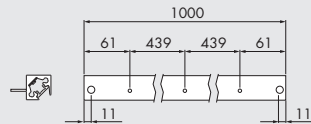

Vb6.583.21.1  
Vb6.583.22

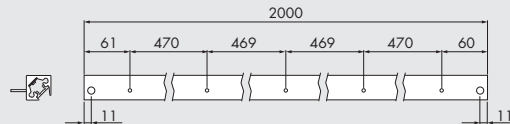

Vb6.583.31.1  
Vb6.583.32

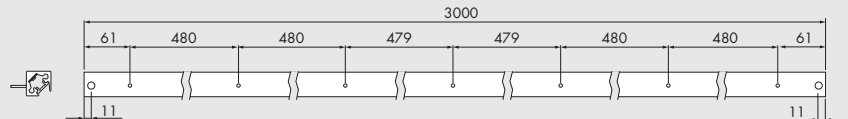



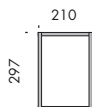
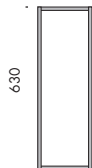
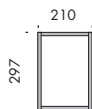
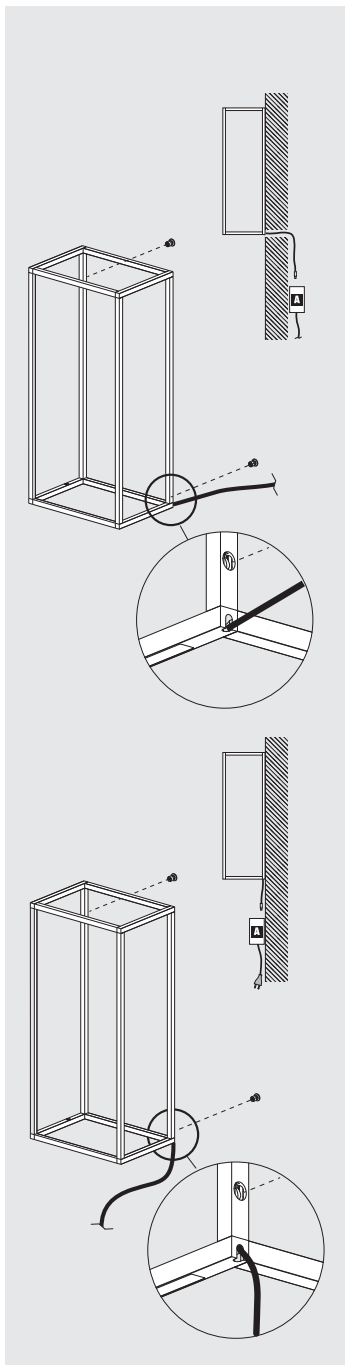

**13° angolo 01** 220-240V 50-60Hz AS IP20 UK CE

**Vb2.583.01.1** acciaio acciaio 3000K 22,5W 0,6

**Vb2.583.02** nero55 3000K 22,5W 0,6

Ra	R9	ies tm/30		sdc	Vf	lm/m	W/m	lm/W
95	90	Rf 93	Rg 102	step 2	24	1250	13	96
V0001	5,9		Ta25 °C	vita media · average life		50000 h	L80 B10	

**13° angolo 02** 220-240V 50-60Hz AS IP20 UK CE

**Vb4.583.01.1** acciaio acciaio 3000K 33W 1

**Vb4.583.02** nero55 3000K 33W 1

Ra	R9	ies tm/30		sdc	Vf	lm/m	W/m	lm/W
95	90	Rf 93	Rg 102	step 2	24	1250	13	96
V0001	5,9		Ta25 °C	vita media · average life		50000 h	L80 B10	



installazione verticale 13° angolo 03  
con ripiani:  
usare kit di fissaggio a parete  
13° angolo 03 vertical installation  
with shelves: use wall fixing kit



kit fissaggio inclusi  
fixing kit included

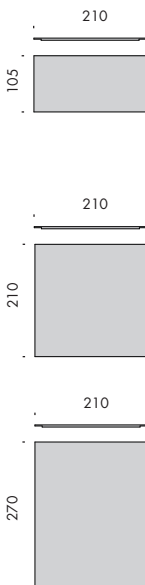
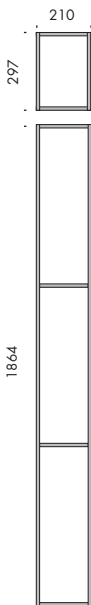
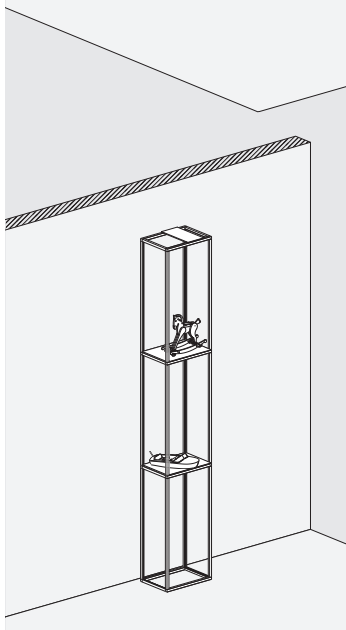
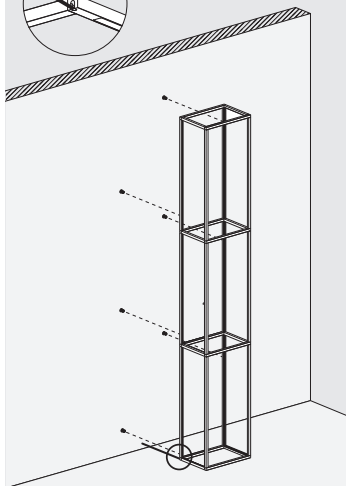

**13° angolo 03** 220-240V 50-60Hz AS IP20 UK CE i

<b>Vb4.583.11</b>	acciaio acciaio	3000K	47W	1,8
<b>Vb4.583.12</b>	nero55	3000K	47W	1,8

Ra	R9	ies tm/30		sdc	Vf	lm/m	W/m	lm/W
95	90	Rf 93	Rg 102	step 2	24	1250	13	96
V0001	5,9		Ta25 °C		vita media · average life		50000 h	L80 B10

**ripiani. shelves.** ★ UK CE i

<b>Vb9.583.81</b>	nero55	0,3
<b>Vb9.583.82</b>	argento hacca	0,3
<b>Vb9.583.83</b>	ottone ap-s	0,3
<b>Vb9.583.86</b>	nero55	0,6
<b>Vb9.583.87</b>	argento hacca	0,6
<b>Vb9.583.88</b>	ottone ap-s	0,6
<b>Vb9.583.91</b>	nero55	0,7
<b>Vb9.583.92</b>	argento hacca	0,7
<b>Vb9.583.93</b>	ottone ap-s	0,7















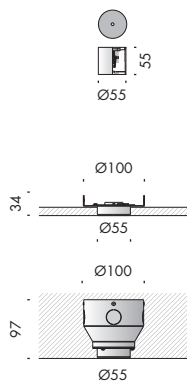
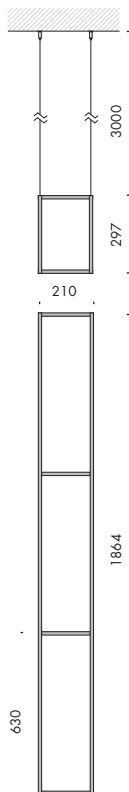
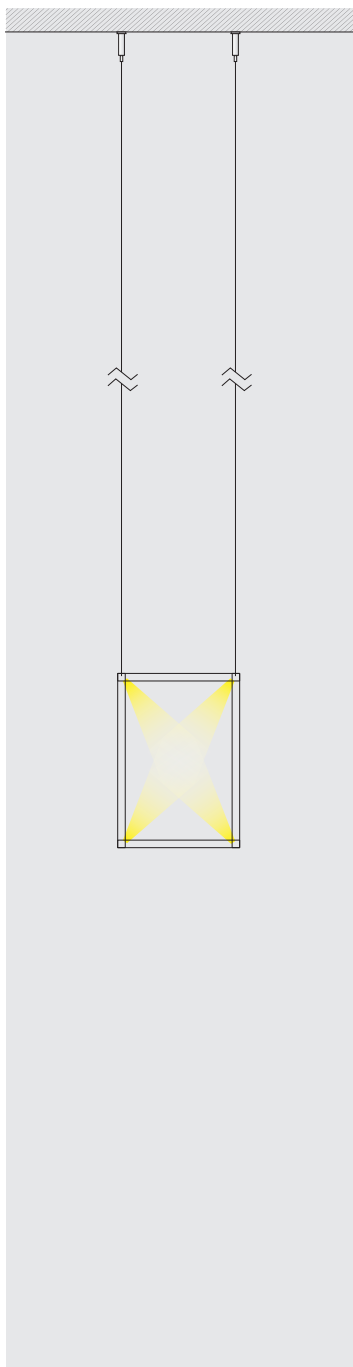

**13° angolo sospensione** 24Vdc

**Vb8.583.01.1** acciaio acciaio 3000K 96W 2

**Vb8.583.02** nero55 3000K 96W 2

Ra	R9	ies tm/30		sdc	Vf	lm/m	W/m	lm/W
95	90	Rf 93	Rg 102	step 2	24	1250	13	96
V0001	5,9	Ta25 °C		vita media · average life		50000 h	L80 B10	

**rosone di alimentazione. ceiling rose.**

**Vb9.001.77** acciaio acciaio 0,3

**Vb9.001.81** nero55 0,3

**Vb9.580.73** scomparsa totale cartongesso fully concealed plasterboard 0,3

**Vb9.580.74** cassaforma laterizio scomparsa totale fully concealed brick housing 0,3

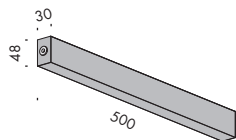

rosone di alimentazione. ceiling rose. 220-240V 50-60Hz   IP20   

**Vb9.550.60** acciaio acciaio 100W 0,7

**Vb9.550.62** nero55 100W 0,7



personalizza la tua luce  
vai su [Vializzuno.com](http://Vializzuno.com)



+

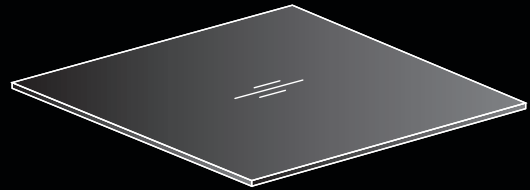

**1. scegli il tuo profilo**  
choose the profil

**2. scegli il ripiano**  
choose the shelf

