

Viabizzuno strada principale della frazione di bizzuno in provincia di ravenna dove tra la casa del popolo e la parrocchia, al n°17, sono nato il ventuno luglio millenovecentocinquantacinque. da qui nasce il nome della fabbrica di produzione fondata nel millenovecentonovantaquattro rappresentata da uno spazio bianco attraversato da due linee. una verticale, rigorosa, essenziale, equilibrata: la luce per la luce; ed una inclinata, irriverente nello spazio, ironica, fuori dagli schemi: la luce per la forma. distinte ma complementari si fondono in un unico nome: Viabizzuno.

Viabizzuno is the name of the main road of the small village bizzuno located in the province of ravenna, where I was born on the 21 07 1955 at n°17, between the 'casa del popolo' and the local parish church. from here the name of the factory founded in nineteen ninety-four represented by a white space intersected by two lines. one vertical, well balanced, logical, essential: the light for the light. the other one dynamic, irreverent, ironic: the light for the form. separate and yet complementary they cast in the same name: Viabizzuno. mario nanni

*i progetti rendono gli oggetti eterni,
le mode li corrompono, gli imbecilli li copiano
e li vendono agli ignoranti e ai deficienti.
noi progettiamo e lavoriamo per aiutare la luce
ad emozionarvi.*

*i frutti delle nostre idee e dei nostri progetti
sono protetti da brevetti
e/o modelli registrati
e/o da diritto d'autore.*

*design makes objects timeless,
fashion corrupts them,
fools copy them and sell them to
ignorants and idiots.
we do projects and work to help light to bring
you true emotion.
the results of our ideas and our projects
are protected by patents
and/or registered models
and/or copyright.*

Viabizzuno raccoglie attorno a sé esperienza, conoscenza e ricerca per poter meglio esprimere il proprio modo di fare luce. questo strumento è un manuale tecnico: la raccolta, il racconto, la spiegazione delle due linee di prodotto che nascono dal pensiero progettuale di Viabizzuno che si identifica in una pagina bianca, pronta ogni volta a cogliere e risolvere una nuova sfida. due linee complementari occupano questo spazio esplorandolo, dilatandolo: si incrociano forti della propria identità, due anime rappresentate dalle collezioni For m e Alvaline. due strumenti che uniti ci permettono di progettare la luce a 360°. il manuale For m e Alvaline diventa un unico libro, ma con due percorsi: in uno è la forma che emoziona e illumina, nell'altro è la progettazione che genera la luce; in un percorso c'è la lampada irriverente, l'oggetto che vive sia nella luce artificiale che in quella naturale, nell'altro c'è il corpo illuminante tecnico che scompare per lasciare spazio solo alla luce. due tipologie di prodotto diverse, ma complementari. è lo strumento per conoscere la nostra luce: quella storica, ma anche quella speciale, sviluppata e realizzata su misura che racconta quanto sia importante che il progetto sia stimolante e che l'interlocutore sia preparato a una progettazione complessa, che richiede tempo e impegno.

progettiamo la luce a 360°.



Viabizzuno draws on all its experience, knowledge and research to fully express its own personal way of creating light. this tool is a technical manual, a collection, account and explanation of the two product ranges generated by Viabizzuno's design concept, which takes the form of a white page, always ready to accept and solve a new challenge. two complementary ranges occupy this space, exploring and expanding it; they intersect, confident in their own identity, two kindred spirits represented by the For m and Alvaline collections. two tools that together enable us to design lighting in 360°. the For m and Alvaline manual becomes a single book but with two pathways; in one it is the shape that excites and illuminates, in the other it is the design that generates the light, in one is the irreverent lamp, the object that is alive in both artificial and natural light, in the other is the efficient light fitting that disappears to make way for light alone, two different but complementary product types. the manual is a tool to learn about our light, both the historical and the special, developed and made to measure, which explains how important it is for the design to be stimulating and for the customer to be prepared for a complex design process, which requires both time and commitment.

we design lighting at 360°.

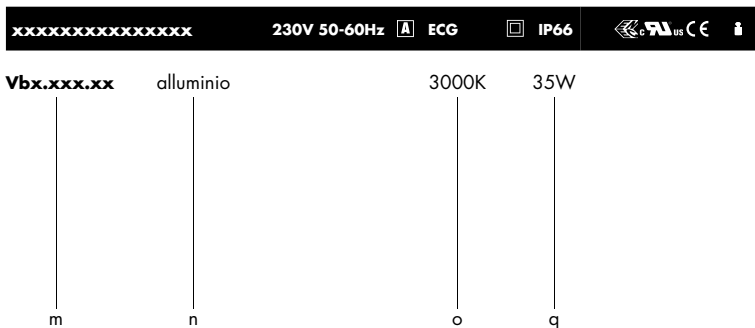
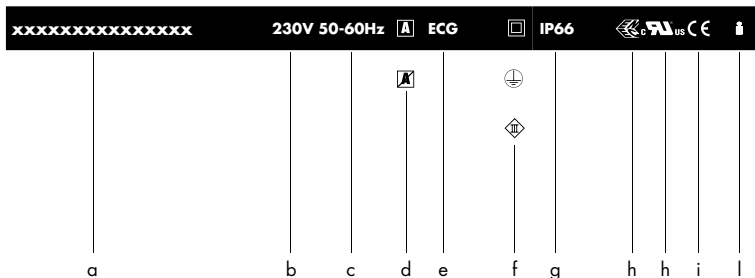
lettura delle tabelle tecniche how to read technical tables



componenti. components. IK10  i

accessori. accessories.										IK10		i
1	2	3	4	5	6	7	8	9	10			
Ra	R9	ies tm-30		sdcM	mA	V _{f (min)}	lm	W	lm/W			
98	98	Rg 103	Rf 96	step 1	350	30,9	1240	10,8	115	A++		
xm000	les19 	Ta25 °C		vita media · average life	500	31,2	1580	15,6	101	A+		
70000 h												
11	12											

bandella tecnica. posizioni standard simbologie.
data plate. standard arrangement of symbols.









a	nome apparecchio di illuminazione · light fitting name
b	tensione di alimentazione · supply rating (Volt)
c	frequenza di alimentazione · supply frequency (Hertz)
d	alimentatore inclusi o esclusi · power supply included or not
e	tipo di alimentatore · type of power supply
f	classe di isolamento · insulation class
g	grado di protezione · protection degree
h	marchio di certificazione · safety and quality standards certification
i	conforme alle direttive europee produced in compliance with EC directives
l	peso netto · net weight (kg)
m	codice · code
n	finiture · colours and finishes
o	temperatura colore sorgente elettronica colour temperature led source (Kelvin)
p	potenza della sorgente · source power (Watt)

componenti. identifica tutti gli elementi indispensabili per la corretta funzionalità e installazione dell'apparecchio di illuminazione.
components. includes all items that are essential to the correct operation and installation of the light fitting.

accessori. si riferisce alle ulteriori parti installabili sull'apparecchio.
accessories. refers to items that can be added to the light fitting.

1	indice di resa cromatica · colour rendering index
2	indice di resa del rosso · red colour rendering index
3	Rf indice di fedeltà colore · colour fidelity index Rg indice di saturazione colore · color gamut index
4	step di macadam · macadam step
5	corrente di alimentazione · power supply current
6	tensione di alimentazione · power supply voltage
7	flusso luminoso · light flux
8	potenza della sorgente · source power
9	efficienza della sorgente · source efficiency
10	classe di efficienza energetica · efficiency class
11	codice sorgente elettronica Viabizzuno · Viabizzuno led source code
12	superficie emittente · light emitting surface (mm)
13	% flusso residuo a fine vita · end life % flux
14	% consentita sotto limite · allowed % under limit

gradi di protezione protection degrees

		IPX0	non protetto no protection		
		 IPX1	protetto contro la caduta verticale di gocce d'acqua protected against water drops falling vertically		IK01 nessuna protezione no protection
		IPX2	protetto contro la caduta di gocce con inclinazione max 15° protected against water drops max inclination 15°		IK01 protetto contro l'energia d'urto 0,15J protected against collision energy
		 IPX3	protetto contro la caduta di gocce con inclinazione max 60° protected against water drops max inclination 60°		IK02 protetto contro l'energia d'urto 0,2J protected against collision energy
IP0X	non protetto no protection	 IPX4	protetto contro spruzzi d'acqua protected against sprinkling water		IK03 protetto contro l'energia d'urto 0,35J protected against collision energy
IP1X	contro corpi estranei >50 mm protection against solid objects	 IPX5	protetto contro getti d'acqua protected against water jets		IK04 protetto contro l'energia d'urto 0,5J protected against collision energy
IP2X	contro corpi estranei >12 mm protection against solid objects	IPX6	protetto contro inondazioni protected against flooding		IK05 protetto contro l'energia d'urto 0,7J protected against collision energy
IP3X	contro corpi estranei >2,5 mm protection against solid objects	 IPX7	per breve immersione protected against brief immersions		IK06 protetto contro l'energia d'urto 1J protected against collision energy
IP4X	contro corpi estranei >1 mm protection against solid objects	 IPX8	per immersione prolungata protected against long immersion		IK07 protetto contro l'energia d'urto 2J protected against collision energy
 IP5X	protezione da polvere dust-protected				IK08 protetto contro l'energia d'urto 5J protected against collision energy
 IP6X	stagno alla polvere dust-proof				IK09 protetto contro l'energia d'urto 10J protected against collision energy
					IK10 protetto contro l'energia d'urto 20J protected against collision energy

legenda simboli symbols key

- ta** tavolo
table
- tr** terra
floor standing
- s** soffitto
ceiling
- P** parete
wall
- sp** sospensione
suspension
- bin** binario
track
- in** incasso
recessed
- st** scomparsa totale
fully concealed
- s+e** segnaletica+emergenza
signalling system+emergency
- bat** portatili autoalimentati a batteria
portable self-powered with battery
- sis** sistemi
systems
- pa** palo
pole
- pt** paletto
bollard
- sd** seduta
sitting
- V** disponibile su · available on *Viabizzuno applight* www.Viabizzuno.com *Viabizzuno online*
-  classe I. solo isolamento fondamentale, le parti conduttrici accessibili sono collegate ad un conduttore di terra. messa a terra tassativa
class I. only basic insulation, accessible conductors are earthed. earthing compulsory
-  classe II. all'isolamento principale è aggiunto un secondo isolamento oppure ai due isolamenti è sostituito un isolamento rinforzato. messa a terra esclusa
class II. basic insulation plus second insulation or both are replaced by reinforced insulation. earthing excluded
-  classe III. alimentazione effettuata con bassissima tensione di sicurezza; sono escluse tensioni superiori a 50V-50Hz. messa a terra non prevista.
class III. very low safety supply tension; not to be used over 50V-50Hz. earthing excluded.
- CE** prodotto conforme alle direttive europee · produced in compliance with ec directives
-  marchio di certificazione europea. certifica che il prodotto è conforme alle norme europee sulla sicurezza
component approved for north american market and suitable to be used and approved as part of a more complex system
- c us** componente certificato per il mercato nord americano idoneo ad essere utilizzato e valutato come parte di un sistema più complesso
component approved for north american market and suitable to be used and approved as part of a more complex system
- KEMA**
KEUR apparecchio di illuminazione approvato da kema · kema approved light fitting
- WRAS** prodotto conforme agli standard presenti nel regno unito che regolamentano la sicurezza e la qualità dell'acqua · product complies with uk standards set out by water regulations
-  apparecchio di illuminazione certificato secondo le normative vigenti in polonia che regolamentano i dispositivi di sicurezza antincendio
certified light fitting according to the regulations about devices for fire safety in force in poland
- ★ prodotto idoneo per essere commercializzato nel mercato cinese
product suitable for the china market
-  prodotto finito idoneo per essere commercializzato nel mercato nord americano · listed product suitable for the north american market

IP20 grado di protezione · protection degree



vetro opalino · opal glass



vetro sabbaiato · sanded glass



vetro nero fumè · black smoke glass



vetro trasparente · transparent glass



vetro bianco latte · white milk glass



crystallo · crystal



policarbonato opalino · opal polycarbonate diffuser



carrabile · drive over

ECG alimentatore elettronico · electronic power supply



alimentatore incluso · power supply included



alimentatore escluso · power supply not included

AR alimentatore remoto incluso · remote power supply included



alimentatore elettronico con controllo intelligente incluso · electronic power supply with smart control included

AiR alimentatore elettronico con controllo intelligente incluso, da installare remoto · electronic power supply with smart control included, to be installed remotely



alimentatore a spina incluso · plug power supply included



trasformatore incluso · transformer included



trasformatore escluso · transformer not included



kit di cablaggio · wiring kit



kit di cablaggio escluso · wiring kit not included



lampadina inclusa. tutti i nostri apparecchi di illuminazione cablati con sorgente elettronica hanno la sorgente luminosa inclusa
bulb included. all our led source light fitting are with lamp included



propulsore dinamico n55 incluso · included

 possibilità di combinazione tra interfaccia n55, propulsore dinamico n55 e lampadina n55 · possible combination between n55 interface, propulsore dinamico n55 and n55 bulb



attenzione: sorgente luminosa led. non guardare mai direttamente a occhio nudo · attention: led light source. never look straight without eye protection



flicker free compatibile con fotocamere digitali · flicker free digital camera friendly



fascio asimmetrico · asymeric beam



fascio ellittico · elliptical beam



wallwasher

l.d. luce diretta · direct light

l.i. luce indiretta · indirect light

.d1 dimmerazione 1-10V · 1-10V dimmable

.d2 dimmerazione dali · dimmable dali

.SA kit luce + emergenza sempre accese. attenzione: non è possibile installare nelle cassaforme laterizio
light kit + permanently lit emergency lamp. please note: cannot be installed in brickwork housing

.SE solo emergenza sempre accesa. attenzione: non è possibile installare nelle cassaforme laterizio
permanently lit emergency lamp only. please note: cannot be installed in brickwork housing



peso netto · net weight (kg)

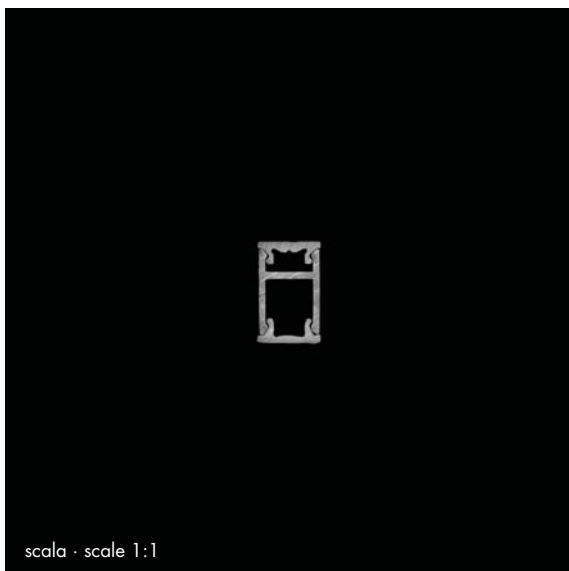

scala · scale 1:1

**apparecchio di illuminazione a parete o soffitto per interni IP20.
realizzato in estruso di alluminio ossidato 13x8mm di sezione ad H, con lunghezze fino a 2110mm con un passo di 100mm.
un lato del profilo si fissa ad un secondo estruso che funge da staffa di fissaggio agevolandone l'installazione.
diffusore in policarbonato satinato della stessa lunghezza del profilo.
cablato con sorgente elettronica lineare con limitatore di corrente integrato, 3000K Ra95 13W/m fino a 27,3W 2620lm. predisposto all'estremità con connettori amp2 maschio e femmina.
alimentatore in tensione costante 24vdc escluso, da installare remoto.
accessori: tappi di chiusura.
finiture: argento opaco.**

**IP20 rated wall or ceiling light fitting for indoor use.
made of 13x8mm oxidised aluminium extrusion, with H section, length up to 2110mm with a 100mm pitch.
a side of the profile can be fixed to a second extrusion that serves as a fixing bracket for an easier installation.
frosted polycarbonate diffuser having the same length of the profile.
wired with a 3000K Ra95 13W/m up to 27.3W 2620lm linear led source with integrated current limiter, fitted with amp2 female or male connectors at the end.
24Vdc constant voltage power supply not included, to be installed remotely.
accessories: closing cups.
finish: matt silver.**





13x8 e entra		24Vdc		IP20		CE	
Vb6.204.31	argento opaco · matt silver	3000K	1,3W	110mm	0,04		
Vb6.204.32	argento opaco · matt silver	3000K	2,6W	210mm	0,07		
Vb6.204.33	argento opaco · matt silver	3000K	3,9W	310mm	0,1		
Vb6.204.34	argento opaco · matt silver	3000K	5,2W	410mm	0,1		
Vb6.204.35	argento opaco · matt silver	3000K	6,5W	510mm	0,2		
Vb6.204.36	argento opaco · matt silver	3000K	7,8W	610mm	0,2		
Vb6.204.37	argento opaco · matt silver	3000K	9,1W	710mm	0,2		
Vb6.204.38	argento opaco · matt silver	3000K	10,4W	810mm	0,3		
Vb6.204.39	argento opaco · matt silver	3000K	11,7W	910mm	0,3		
Vb6.204.40	argento opaco · matt silver	3000K	13W	1010mm	0,3		
Vb6.204.41	argento opaco · matt silver	3000K	14,3W	1110mm	0,4		
Vb6.204.42	argento opaco · matt silver	3000K	15,6W	1210mm	0,4		
Vb6.204.43	argento opaco · matt silver	3000K	16,9W	1310mm	0,4		
Vb6.204.44	argento opaco · matt silver	3000K	18,2W	1410mm	0,5		
Vb6.204.45	argento opaco · matt silver	3000K	19,5W	1510mm	0,5		
Vb6.204.46	argento opaco · matt silver	3000K	20,8W	1610mm	0,5		
Vb6.204.47	argento opaco · matt silver	3000K	22,1W	1710mm	0,5		
Vb6.204.48	argento opaco · matt silver	3000K	23,4W	1810mm	0,6		
Vb6.204.49	argento opaco · matt silver	3000K	24,7W	1910mm	0,6		
Vb6.204.50	argento opaco · matt silver	3000K	26W	2010mm	0,7		
Vb6.204.51	argento opaco · matt silver	3000K	27,3W	2110mm	0,7		

connettore m amp2
m amp2 connector

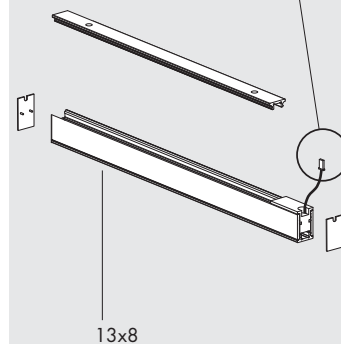
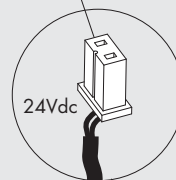

Ra	R9	ies tm/30		sdcm	Vf	lm/m	W/m	lm/W	
95	90	Rf 93	Rg 102	step 2	24	1250	13	96	A+
V0001	5,9	Ta25 °C		vita media · average life	50000 h	L80	B10		

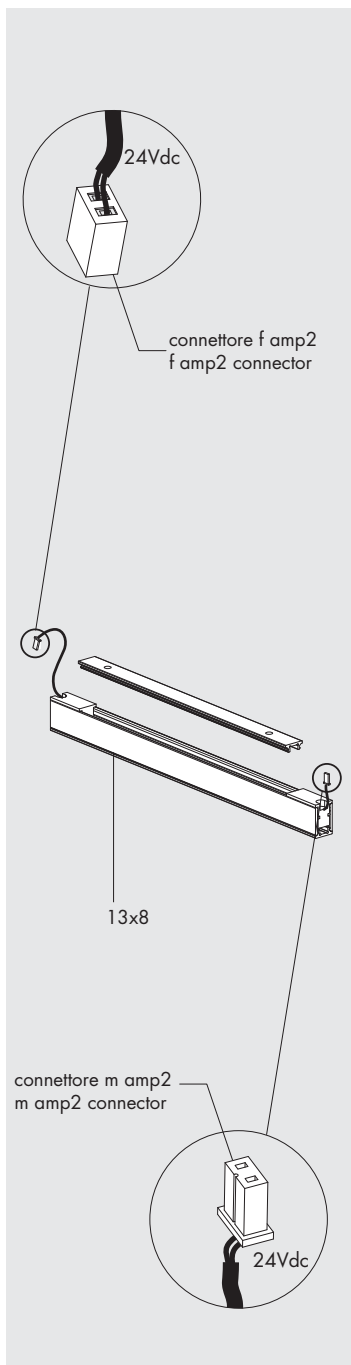

13x8 e-e entra-esce		24Vdc					CE	
Vb6.204.01	argento opaco · matt silver	3000K	1,3W	110mm	0,04			
Vb6.204.02	argento opaco · matt silver	3000K	2,6W	210mm	0,07			
Vb6.204.03	argento opaco · matt silver	3000K	3,9W	310mm	0,1			
Vb6.204.04	argento opaco · matt silver	3000K	5,2W	410mm	0,1			
Vb6.204.05	argento opaco · matt silver	3000K	6,5W	510mm	0,2			
Vb6.204.06	argento opaco · matt silver	3000K	7,8W	610mm	0,2			
Vb6.204.07	argento opaco · matt silver	3000K	9,1W	710mm	0,2			
Vb6.204.08	argento opaco · matt silver	3000K	10,4W	810mm	0,3			
Vb6.204.09	argento opaco · matt silver	3000K	11,7W	910mm	0,3			
Vb6.204.10	argento opaco · matt silver	3000K	13W	1010mm	0,3			
Vb6.204.11	argento opaco · matt silver	3000K	14,3W	1110mm	0,4			
Vb6.204.12	argento opaco · matt silver	3000K	15,6W	1210mm	0,4			
Vb6.204.13	argento opaco · matt silver	3000K	16,9W	1310mm	0,4			
Vb6.204.14	argento opaco · matt silver	3000K	18,2W	1410mm	0,5			
Vb6.204.15	argento opaco · matt silver	3000K	19,5W	1510mm	0,5			
Vb6.204.16	argento opaco · matt silver	3000K	20,8W	1610mm	0,5			
Vb6.204.17	argento opaco · matt silver	3000K	22,1W	1710mm	0,6			
Vb6.204.18	argento opaco · matt silver	3000K	23,4W	1810mm	0,6			
Vb6.204.19	argento opaco · matt silver	3000K	24,7W	1910mm	0,6			
Vb6.204.20	argento opaco · matt silver	3000K	26W	2010mm	0,7			
Vb6.204.21	argento opaco · matt silver	3000K	27,3W	2110mm	0,7			

Ra	R9	ies tm/30		sdc	Vf	lm/m	W/m	lm/W	
95	90	Rf 93	Rg 102	step 2	24	1250	13	96	A+
V0001	5,9	Ta25 °C		vita media · average life	50000 h	L80	B10		

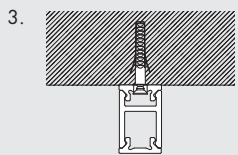
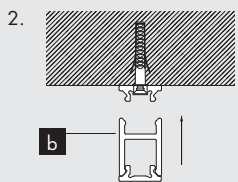
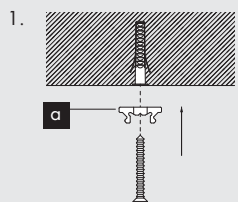
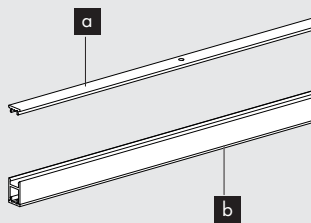

a coperchio in alluminio
aluminium cover

b 13x8

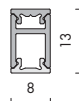

13x8



f6.204.91	profilo vuoto + policarbonato empty profile + polycarbonate	4 pz · pcs	3000mm	2
f6.204.90	profilo vuoto + policarbonato empty profile + polycarbonate	100 pz · pcs	3000mm	50

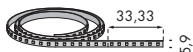

linea di luce Ra95/13

24Vdc



Vb6.250.121		2700K 6000mm		0,6					
Ra	R9	ies tm/30		sdc	Vf	lm/m	W/m	lm/W	
95	90	Rf 90	Rg 98	step 2	24	1200	13	92	A+
V0000	5,9	Ta25 °C		vita media · average life		50000 h	L80 B10		

Vb6.250.122		3000K 6000mm		0,6					
Ra	R9	ies tm/30		sdc	Vf	lm/m	W/m	lm/W	
95	90	Rf 93	Rg 102	step 2	24	1250	13	96	A+
V0001	5,9	Ta25 °C		vita media · average life		50000 h	L80 B10		

Vb6.250.123		4000K 6000mm		0,6					
Ra	R9	ies tm/30		sdc	Vf	lm/m	W/m	lm/W	
95	95	Rf 90	Rg 98	step 2	24	1300	13	100	A+
V0003	5,9	Ta25 °C		vita media · average life		50000 h	L80 B10		

Vb6.250.124		5000K 6000mm		0,6					
Ra	R9	ies tm/30		sdc	Vf	lm/m	W/m	lm/W	
95	95	Rf 90	Rg 98	step 2	24	1300	13	100	A+
V0005	5,9	Ta25 °C		vita media · average life		50000 h	L80 B10		

cavi con connettore femmina amp2. cables with amp2 female connector. IP20 ☆ CE ⓘ

f9.204.90

150mm 0,01

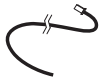

cavi con connettori m/f amp2. cables with m/f amp2 connectors. IP20 ☆ CE ⓘ

f9.204.91

2000mm 0,3

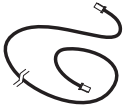

accessori. accessories.

☆ CE ⓘ

f9.204.80 tappi di chiusura · closing caps

100 pz · pcs 0,1

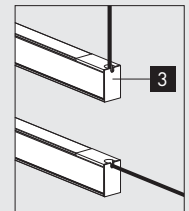
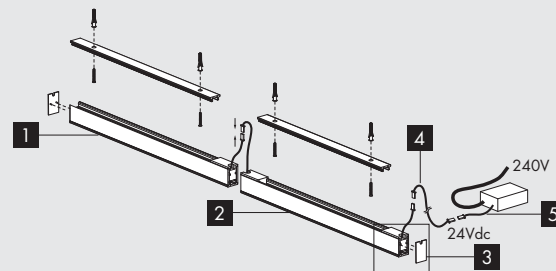
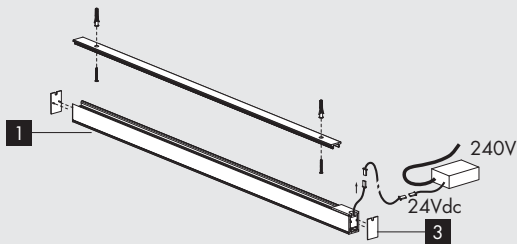
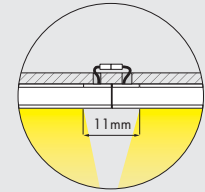
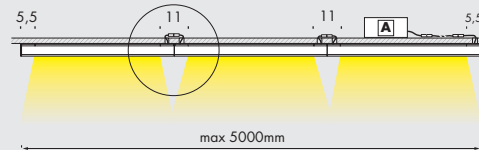
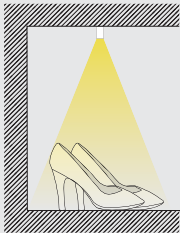
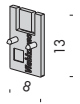

- 1** 13x8
n.1 connettore maschio amp2 · male connector
- 2** 13x8
n.2 connettori m/f amp2 · connectors
- 3** tappo di chiusura incluso
end cap included

- 4** f9.204.91 l.2000mm cavo · cable
n.2 connettori m/f amp2 · connectors
- 5** f9.204.90 l.150mm cavo · cable
n.1 connettore femmina amp2 · connector

