

Viabizzuno strada principale della frazione di bizzuno in provincia di ravenna dove tra la casa del popolo e la parrocchia, al n°17, sono nato il ventuno luglio millenovecentocinquantacinque. da qui nasce il nome della fabbrica di produzione fondata nel millenovecentonovantaquattro rappresentata da uno spazio bianco attraversato da due linee. una verticale, rigorosa, essenziale, equilibrata: la luce per la luce; ed una inclinata, irriverente nello spazio, ironica, fuori dagli schemi: la luce per la forma. distinte ma complementari si fondono in un unico nome: Viabizzuno.

Viabizzuno is the name of the main road of the small village bizzuno located in the province of ravenna, where I was born on the twenty-first july nineteenfiftyfive at n°17, between the 'casa del popolo' and the local parish church. from here the name of the factory founded in nineteen ninety-four represented by a white space intersected by two lines. one vertical, well balanced, logical, essential: the light for the light. the other one dynamic, irreverent, ironic: the light for the form. separate and yet complementary they cast in the same name: Viabizzuno. marionanni

*i progetti rendono gli oggetti eterni,
le mode li corrompono, gli imbecilli li copiano
e li vendono agli ignoranti e ai deficienti.
noi progettiamo e lavoriamo per aiutare la luce
ad emozionarvi.*

*i frutti delle nostre idee e dei nostri progetti
sono protetti da brevetti
e/o modelli registrati
e/o da diritto d'autore.*

design makes objects timeless,
fashion corrupts them,
fools copy them and sell them to
ignorants and idiots.
we do projects and work to help light to bring
you true emotion.
the results of our ideas and our projects
are protected by patents
and/or registered models
and/or copyright.

al fine di offrire ai nostri clienti la massima qualità della luce utilizzando le più avanzate tecnologie, forti del nostro sapere artigiano costruito in italia, aggiorniamo costantemente i nostri apparecchi di illuminazione.

Viabizzuno si riserva il diritto di apportare ai propri modelli, senza nessun preavviso, qualsiasi modifica ritenesse opportuna. per dimensioni e codici fanno fede i nostri strumenti di lavoro www.Viabizzuno.com, Viacommerce@, Viabizzunoapplight e Viabizzunoonline.

in order to provide to our customers the maximum quality of light using the most advanced technologies, being strong of our artisan knowledge made in italy, we constantly update our lighting fixtures.

Viabizzuno reserves the right to make any modification, considered worthwhile, to its own models, without any notification. for valid dimensions and codes please consult our working tools www.Viabizzuno.com, Viacommerce@, Viabizzunoapplight and Viabizzunoonline.

lettura delle tabelle tecniche how to read technical tables

XXXXXXXXXXXXXXXXXX										
230V 50-60Hz				A	⊕	IP66		US	CE	
a	b	c	d	e	f	g	g	h	i	

XXXXXXXXXXXXXXXXXX										
230V 50-60Hz				A	⊕	IP66		US	CE	
Vbx.xxx.xx	nero55	3000K		35W	1,5					
l	m	n	o	i						

componenti. components.	IK10	CE	
--------------------------------	------	----	--

accessori. accessories.	IK10	CE	
--------------------------------	------	----	--

1	2	3	4	5	6	7	8	9	10
---	---	---	---	---	---	---	---	---	----

Ra	R9	ies tm/30		sdcM	Vf	lm/m	W/m	lm/W	
95	90	Rf 90	Rg 98	step 2	24	1200	13	92	F
V0000	5,9		Ta25 °C	vita media · average life	50000 h	L80	B10		

11	12	13	14
----	----	----	----

bandella tecnica. posizioni standard simbologie.
data plate. standard arrangement of symbols.

a	nome apparecchio di illuminazione · light fitting name
b	tensione di alimentazione · supply rating (Volt)
c	frequenza di alimentazione · supply frequency (Hertz)
d	alimentatore incluso o escluso · power supply included or not included
e	classe di isolamento · insulation class
f	grado di protezione · protection degree
g	marchio di certificazione · safety and quality standards certification
h	conforme alle direttive europee produced in compliance with EC directives
i	peso netto · net weight (kg)
l	codice · code
m	finitura · finish
n	temperatura colore sorgente elettronica colour temperature led source (Kelvin)
o	potenza della sorgente · source power (Watt)

componenti. identifica tutti gli elementi indispensabili per la corretta funzionalità e installazione dell'apparecchio di illuminazione.
components. includes all items that are essential to the correct operation and installation of the light fitting.















accessori. si riferisce alle ulteriori parti installabili sull'apparecchio.
accessories. refers to items that can be added to the light fitting.

1	indice di resa cromatica · colour rendering index
2	indice di resa del rosso · red colour rendering index
3	Rf indice di fedeltà colore · colour fidelity index Rg indice di saturazione colore · color gamut index
4	step di macadam · macadam step
5	corrente di alimentazione · power supply current
6	tensione di alimentazione · power supply voltage
7	flusso luminoso · light flux
8	potenza della sorgente · source power
9	efficienza della sorgente · source efficiency
10	classe di efficienza energetica · efficiency class
11	codice sorgente elettronica Viabizzuno · Viabizzuno led source code
12	superficie emittente · light emitting surface (mm)
13	% flusso residuo a fine vita · end life % flux
14	% consentita sotto limite · allowed % under limit

gradi di protezione protection degrees

IP0X	<i>non protetto</i> no protection	IPX0	<i>non protetto</i> no protection	IK01	<i>nessuna protezione</i> no protection
IP1X	<i>contro corpi estranei >50 mm</i> protection against solid objects	IPX1	<i>protetto contro la caduta verticale di gocce d'acqua</i> protected against water drops falling vertically	IK01	<i>protetto contro l'energia d'urto 0,15J</i> protected against collision energy
IP2X	<i>contro corpi estranei >12 mm</i> protection against solid objects	IPX2	<i>protetto contro la caduta di gocce con inclinazione max 15°</i> protected against water drops max inclination 15°	IK02	<i>protetto contro l'energia d'urto 0,2J</i> protected against collision energy
IP3X	<i>contro corpi estranei >2,5 mm</i> protection against solid objects	IPX3	<i>protetto contro la caduta di gocce con inclinazione max 60°</i> protected against water drops max inclination 60°	IK03	<i>protetto contro l'energia d'urto 0,35J</i> protected against collision energy
IP4X	<i>contro corpi estranei >1 mm</i> protection against solid objects	IPX4	<i>protetto contro spruzzi d'acqua</i> protected against sprinkling water	IK04	<i>protetto contro l'energia d'urto 0,5J</i> protected against collision energy
IP5X	<i>protezione da polvere</i> dust-protected	IPX5	<i>protetto contro getti d'acqua</i> protected against water jets	IK05	<i>protetto contro l'energia d'urto 0,7J</i> protected against collision energy
IP6X	<i>stagno alla polvere</i> dust-proof	IPX6	<i>protetto contro inondazioni</i> protected against flooding	IK06	<i>protetto contro l'energia d'urto 1J</i> protected against collision energy
		IPX7	<i>per breve immersione</i> protected against brief immersions	IK07	<i>protetto contro l'energia d'urto 2J</i> protected against collision energy
		IPX8	<i>per immersione prolungata</i> protected against long immersion	IK08	<i>protetto contro l'energia d'urto 5J</i> protected against collision energy
				IK09	<i>protetto contro l'energia d'urto 10J</i> protected against collision energy
				IK10	<i>protetto contro l'energia d'urto 20J</i> protected against collision energy

legenda simboli symbols key

-  tavolo · table
-  terra · floor standing
-  soffitto · ceiling
-  parete · wall
-  sospensione · suspension
-  binario · track
-  incasso · recessed
-  scomparsa totale · fully concealed
-  segnaletica+emergenza · signalling system+emergency
-  portatili autoalimentati a batteria · portable self-powered with battery
-  sistemi · systems
-  palo · pole
-  paletto · bollard
-  seduta · sitting

 disponibile su · available on [Viabizzuno apflight](http://Viabizzuno.aplight.com) www.Viabizzuno.com [Viabizzuno online](http://Viabizzuno.online)

 classe I. solo isolamento fondamentale, le parti conduttrici accessibili sono collegate ad un conduttore di terra. messa a terra tassativa
class I. only basic insulation, accessible conductors are earthed. earthing compulsory

 classe II. all'isolamento principale è aggiunto un secondo isolamento oppure ai due isolamenti è sostituito un isolamento rinforzato. messa a terra esclusa
class II. basic insulation plus second insulation or both are replaced by reinforced insulation. earthing excluded

 classe III. alimentazione effettuata con bassissima tensione di sicurezza; sono escluse tensioni superiori a 50V-50Hz. messa a terra non prevista.
class III. very low safety supply tension; not to be used over 50V-50Hz. earthing excluded.

 prodotto conforme alle direttive europee · produced in compliance with ec directives

 marchio di certificazione europea. certifica che il prodotto è conforme alle norme europee sulla sicurezza
component approved for north american market and suitable to be used and approved as part of a more complex system

 componente certificato per il mercato nord americano idoneo ad essere utilizzato e valutato come parte di in un sistema più complesso
component approved for north american market and suitable to be used and approved as part of a more complex system

 apparecchio di illuminazione approvato da kema · kema approved light fitting

 prodotto conforme agli standard presenti nel regno unito che regolamentano la sicurezza e la qualità dell'acqua · product complies with uk standards set out by water regulations

 apparecchio di illuminazione certificato secondo le normative vigenti in polonia che regolamentano i dispositivi di sicurezza antincendio
certified light fitting according to the regulations about devices for fire safety in force in poland

 prodotto idoneo per essere commercializzato nel mercato cinese · product suitable for the china market

 prodotto finito idoneo per essere commercializzato nel mercato nord americano · listed product suitable for the north american market

 prodotto conforme alla legislazione vigente nel regno unito · produced in compliance with UK legislation

 apparecchio di illuminazione certificato per il mercato cinese
light fitting certified for china market

-  *vetro opalino* · opal glass
-  *vetro sabbiato* · sanded glass
-  *vetro nero fumè* · black smoke glass
-  *vetro trasparente* · transparent glass
-  *vetro bianco latte* · white milk glass
-  *crystallo* · crystal
-  *policarbonato opalino* · opal polycarbonate diffuser
-  *carrabile* · drive over
-  *alimentatore incluso* · power supply included
-  *alimentatore escluso* · power supply not included
-  *alimentatore remoto incluso* · remote power supply included
-  *alimentatore elettronico con controllo intelligente incluso* · electronic power supply with smart control included
-  *alimentatore elettronico con controllo intelligente incluso, da installare remoto* · electronic power supply with smart control included, to be installed remotely
-  *alimentatore a spina incluso* · plug power supply included
-  *trasformatore incluso* · transformer included
-  *trasformatore escluso* · transformer not included
-  *kit di cablaggio* · wiring kit
-  *kit di cablaggio escluso* · wiring kit not included
-  *lampadina con sorgente elettronica led, ad incandescenza, alogena o fluorescente inclusa.*
bulb with led electronic source, incandescent, halogen or fluorescent included.
-  *lampadina con sorgente elettronica led, ad incandescenza, alogena o fluorescente esclusa.*
bulb with led electronic source, incandescent, halogen or fluorescent not included.
-  *propulsore dinamico n55 incluso* · included
-  *possibilità di combinazione tra interfaccia n55, propulsore dinamico n55 e lampadina n55* · possible combination between n55 interface, propulsore dinamico n55 and n55 bulb
-  *attenzione: sorgente luminosa led. non guardare mai direttamente a occhio nudo* · attention: led light source. never look straight without eye protection
-  *flicker free compatibile con fotocamere digitali* · flicker free digital camera friendly
- l.d.** *luce diretta* · direct light
- l.i.** *luce indiretta* · indirect light
- .d1** *dimmerazione 1-10V* · 1-10V dimmable
- .d2** *dimmerazione dali* · dimmable dali
- .SA** *kit luce + emergenza sempre accese. attenzione: non è possibile installare nelle cassaforme laterizio*
light kit + permanently lit emergency lamp. please note: cannot be installed in brickwork housing
- .SE** *solo emergenza sempre accesa. attenzione: non è possibile installare nelle cassaforme laterizio*
permanently lit emergency lamp only. please note: cannot be installed in brickwork housing
-  *peso netto* · net weight (kg)



apparecchio di illuminazione per interni ed esterni IP65 realizzato in acciaio inox AISI 316L e AISI 304.

modelli:

cubo 15 soffitto 155x155x80mm, cubo 15 bandiera 155x155x75mm con staffa regolabile di fissaggio 70mm, orientabile di 150° sull'asse orizzontale.

cablato con kit sorgente elettronica 3000K 11,9W con fascio simmetrico o asimmetrico

alimentatore 240V 50-60Hz incluso.

accessori: vetro sabbato, vetro trasparente, vetro antiurto sabbato e trasparente IK09, cassaforma, alette frangiluce.

finiture: inox 316L lucido, inox 316L satinato, acciaio cor-ten, ottone naturale, bruno antico, nero notte, scurodivals, grigio argento, bianco V. la versione inox 316L lucido è idonea anche per l'installazione in ambiente marittimo.

IP65 rated light fitting for indoor and outdoor use made of AISI 316L and AISI 304 stainless steel.

versions:

cubo 15 ceiling version 155x155x80mm,

cubo 15 flag version 155x155x75mm with a 70mm long adjustable fixing bracket, adjustable by 150° on the horizontal axis. wired with 3000K 11.9W led source kit with symmetric or asymmetric beam.

240V 50-60Hz power supply included.

accessories: sanded glass, transparent glass, IK09 shock-resistant transparent and sanded glass, housing, anti-glare louvres.

finishes: polished 316L stainless steel, satin 316L stainless steel, cor-ten steel, natural brass, antique brown, night black, scurodivals, silver grey, bianco V. the 316L polished stainless steel version can also be installed in marine environment.

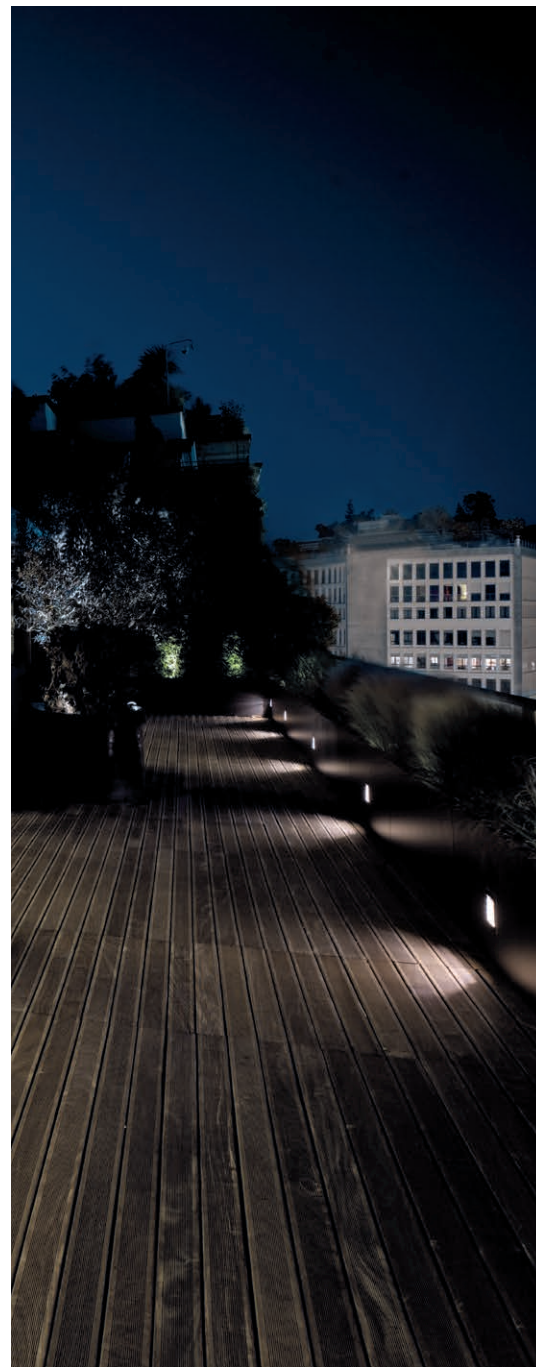
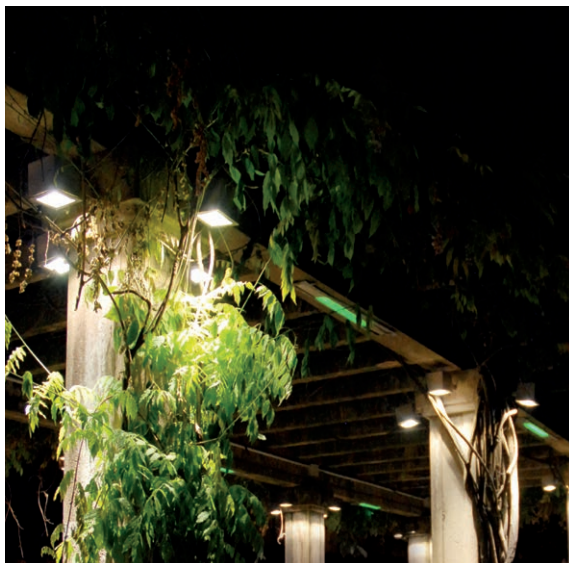

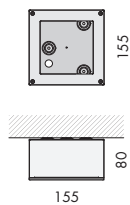

cubo 15 soffitto



IP65



CE



f6.107.21	inox 316L lucido idoneo anche in ambiente marittimo polished 316L stainless steel suitable in marine environment	1,2
f6.107.22	inox 316L satinato satined 316L stainless steel	1,2
f6.198.01	acciaio cor-ten · cor-ten steel	1,2
Vb6.107.26	ottone naturale · natural brass	1,2
f6.198.02	bruno antico · antique brown	1,2
f6.198.03	nero notte · night black	1,2
f6.198.04	scurodivals	1,2
f6.198.05	grigio argento · silver grey	1,2
f6.198.70	bianco V	1,2

interasse fori per installazione a parete
wall installation hole distance

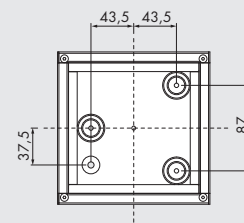

fissare il corpo a parete
con tasselli e viti adatti
fasten the body to the wall
with the suitable anchors and screws

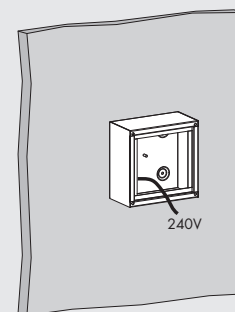
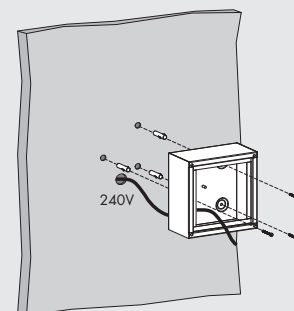

gradi di rotazione
rotation degrees

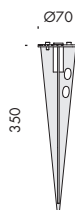
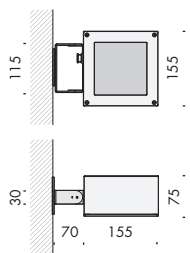
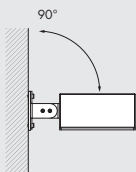
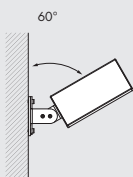
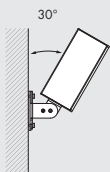
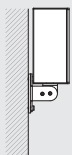

cubo 15 bandiera



IP65



f6.107.23	inox 316L lucido idoneo anche in ambiente marittimo polished 316L stainless steel suitable in marine environment	1,4
f6.107.24	inox 316L satinato satined 316L stainless steel	1,4
f6.198.06	acciaio cor-ten · cor-ten steel	1,4
Vb6.107.77	ottone naturale · natural brass	1,4
f6.198.07	bruno antico · antique brown	1,4
f6.198.08	nero notte · night black	1,4
f6.198.09	scurodivals	1,4
f6.198.10	grigio argento · silver grey	1,4
f6.198.71	bianco V	1,4

accessori cubo 15 bandiera. accessories.



f9.009.01	flangia per rotazione 120° rotation flange	0,2
f9.009.02	picchetto fissaggio a terra ground fixing peg	0,7

flangia per rotazione 120° f9.009.01
rotation flange

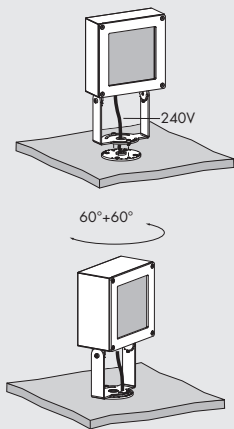

picchetto fissaggio a terra f9.009.02
ground fixing peg

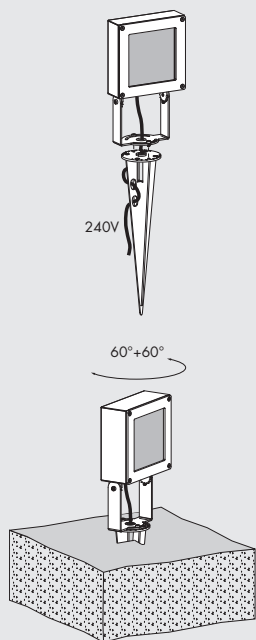

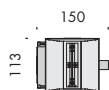
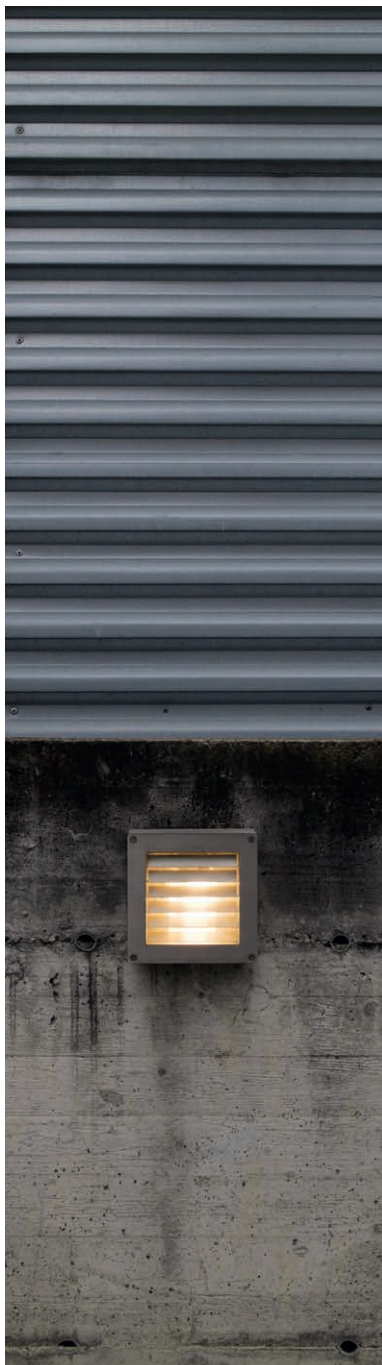

kit	240V 50-60Hz							
------------	---------------------	--	--	--	--	--	--	--

Vb9.190.30 riflettore simmetrico
symmetrical reflector 3000K 0,6

Ra	R9	ies tm-30		sdc	mA	V _{f(min)}	lm	W	lm/W
97	90	Rf 96	Rg 100	step 2	500	23,7	1002	11,9	84
dz011	10	Ta25 °C		vita media · average life		50000 h	L80	B10	

Vb9.190.31 riflettore asimmetrico
asymmetrical reflector 3000K 0,6

Ra	R9	ies tm-30		sdc	mA	V _{f(min)}	lm	W	lm/W
97	90	Rf 96	Rg 100	step 2	500	23,7	1002	11,9	84
dz011	10	Ta25 °C		vita media · average life		50000 h	L80	B10	

Vb9.190.91 riflettore asimmetrico champagne
champagne asymmetrical reflector 3000K 0,6

Ra	R9	ies tm-30		sdc	mA	V _{f(min)}	lm	W	lm/W
97	90	Rf 96	Rg 100	step 2	500	23,7	1002	11,9	84
dz011	10	Ta25 °C		vita media · average life		50000 h	L80	B10	

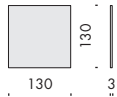

vetro. glass.

UK
CA CE ⓘ

f6.107.28 sabbato · sanded

0,2

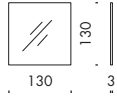

f6.107.29 trasparente · transparent

0,2

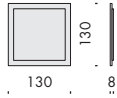

vetro antiurto. shock-resistant glass.

IK09 UK
CA CE ⓘ

f6.107.30 antiurto sabbato · sanded shock-resistant

0,3

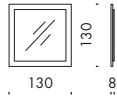

f6.107.31 antiurto trasparente · transparent shock-resistant

0,3

accessori. accessories.

UK
CA CE ⓘ

f6.107.12 cassaforma laterizio inox · stainless steel brick housing

1,2

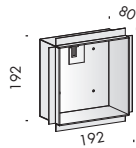

f6.107.11 alette frangiluce inox satinato per vetro trasparente
anti-glare louvres satin stainless steel for transparent glass

0,1

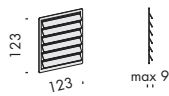

piegare le alette frangiluce a seconda dell'effetto di luce desiderato
properly bend the adjustable louvres according to the lighting effect required

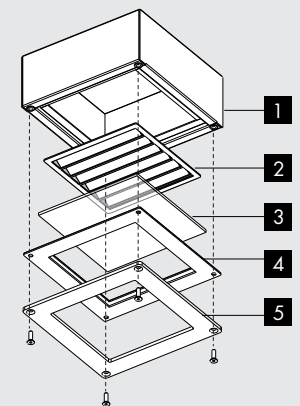
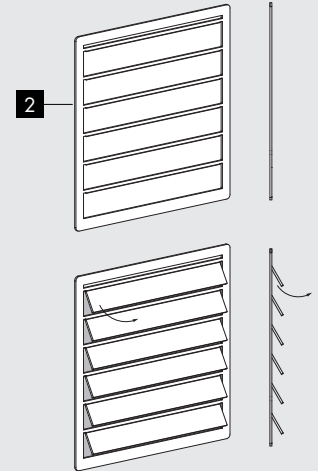

- 1 cubo 15
- 2 f6.107.11
- 3 vetro trasparente
transparent glass
- 4 guarnizione · gasket
- 5 cornice · frame