

*Viabizzuno strada principale della frazione di bizzuno in provincia di ravenna dove tra la casa del popolo e la parrocchia, al n°17, sono nato il ventuno luglio millenovecentocinquantacinque. da qui nasce il nome della fabbrica di produzione fondata nel millenovecentonovantaquattro rappresentata da uno spazio bianco attraversato da due linee. una verticale, rigorosa, essenziale, equilibrata: la luce per la luce; ed una inclinata, irriverente nello spazio, ironica, fuori dagli schemi: la luce per la forma. distinte ma complementari si fondono in un unico nome: Viabizzuno.*

Viabizzuno is the name of the main road of the small village bizzuno located in the province of ravenna, where I was born on the twenty-first july nineteenfiftyfive at n°17, between the 'casa del popolo' and the local parish church. from here the name of the factory founded in nineteen ninety-four represented by a white space intersected by two lines. one vertical, well balanced, logical, essential: the light for the light. the other one dynamic, irreverent, ironic: the light for the form. separate and yet complementary they cast in the same name: Viabizzuno. marionanni

*i progetti rendono gli oggetti eterni,  
le mode li corrompono, gli imbecilli li copiano  
e li vendono agli ignoranti e ai deficienti.  
noi progettiamo e lavoriamo per aiutare la luce  
ad emozionarvi.*

*i frutti delle nostre idee e dei nostri progetti  
sono protetti da brevetti  
e/o modelli registrati  
e/o da diritto d'autore.*

design makes objects timeless,  
fashion corrupts them,  
fools copy them and sell them to  
ignorants and idiots.  
we do projects and work to help light to bring  
you true emotion.  
the results of our ideas and our projects  
are protected by patents  
and/or registered models  
and/or copyright.

*al fine di offrire ai nostri clienti la massima qualità della luce utilizzando le più avanzate tecnologie, forti del nostro sapere artigiano costruito in italia, aggiorniamo costantemente i nostri apparecchi di illuminazione.*

*Viabizzuno si riserva il diritto di apportare ai propri modelli, senza nessun preavviso, qualsiasi modifica ritenesse opportuna. per dimensioni e codici fanno fede i nostri strumenti di lavoro [www.Viabizzuno.com](http://www.Viabizzuno.com), [Viacommerce@](mailto:Viacommerce@), [Viabizzunoapplight](http://Viabizzunoapplight) e [Viabizzunoonline](http://Viabizzunoonline).*

*in order to provide to our customers the maximum quality of light using the most advanced technologies, being strong of our artisan knowledge made in italy, we constantly update our lighting fixtures.*

*Viabizzuno reserves the right to make any modification, considered worthwhile, to its own models, without any notification. for valid dimensions and codes please consult our working tools [www.Viabizzuno.com](http://www.Viabizzuno.com), [Viacommerce@](mailto:Viacommerce@), [Viabizzunoapplight](http://Viabizzunoapplight) and [Viabizzunoonline](http://Viabizzunoonline).*

# lettura delle tabelle tecniche how to read technical tables

XXXXXXXXXXXXXXXXXX										
230V 50-60Hz				A	⊕	IP66		US	CE	
a	b	c	d	e	f	g	g	h	i	

XXXXXXXXXXXXXXXXXX										
230V 50-60Hz				A	⊕	IP66		US	CE	
Vbx.xxx.xx	nero55	3000K		35W	1,5					
l	m	n	o	i						

<b>componenti. components.</b>	IK10	CE	
--------------------------------	------	----	--

<b>accessori. accessories.</b>	IK10	CE	
--------------------------------	------	----	--

1	2	3	4	5	6	7	8	9	10
---	---	---	---	---	---	---	---	---	----

Ra	R9	ies tm/30		sdcM	Vf	lm/m	W/m	lm/W	
95	90	Rf 90	Rg 98	step 2	24	1200	13	92	F
V0000	5,9		Ta25 °C	vita media · average life	50000 h	L80	B10		

11	12	13	14
----	----	----	----

bandella tecnica. posizioni standard simbologie.  
data plate. standard arrangement of symbols.

a	nome apparecchio di illuminazione · light fitting name
b	tensione di alimentazione · supply rating (Volt)
c	frequenza di alimentazione · supply frequency (Hertz)
d	alimentatore incluso o escluso · power supply included or not included
e	classe di isolamento · insulation class
f	grado di protezione · protection degree
g	marchio di certificazione · safety and quality standards certification
h	conforme alle direttive europee produced in compliance with EC directives
i	peso netto · net weight (kg)
l	codice · code
m	finitura · finish
n	temperatura colore sorgente elettronica colour temperature led source (Kelvin)
o	potenza della sorgente · source power (Watt)

componenti. identifica tutti gli elementi indispensabili per la corretta funzionalità e installazione dell'apparecchio di illuminazione.  
components. includes all items that are essential to the correct operation and installation of the light fitting.















accessori. si riferisce alle ulteriori parti installabili sull'apparecchio.  
accessories. refers to items that can be added to the light fitting.

1	indice di resa cromatica · colour rendering index
2	indice di resa del rosso · red colour rendering index
3	Rf indice di fedeltà colore · colour fidelity index Rg indice di saturazione colore · color gamut index
4	step di macadam · macadam step
5	corrente di alimentazione · power supply current
6	tensione di alimentazione · power supply voltage
7	flusso luminoso · light flux
8	potenza della sorgente · source power
9	efficienza della sorgente · source efficiency
10	classe di efficienza energetica · efficiency class
11	codice sorgente elettronica Viabizzuno · Viabizzuno led source code
12	superficie emittente · light emitting surface (mm)
13	% flusso residuo a fine vita · end life % flux
14	% consentita sotto limite · allowed % under limit

## gradi di protezione protection degrees

IP0X	<i>non protetto</i> no protection	IPX0	<i>non protetto</i> no protection	IK01	<i>nessuna protezione</i> no protection
IP1X	<i>contro corpi estranei &gt;50 mm</i> protection against solid objects	IPX1	<i>protetto contro la caduta verticale di gocce d'acqua</i> protected against water drops falling vertically	IK01	<i>protetto contro l'energia d'urto 0,15J</i> protected against collision energy
IP2X	<i>contro corpi estranei &gt;12 mm</i> protection against solid objects	IPX2	<i>protetto contro la caduta di gocce con inclinazione max 15°</i> protected against water drops max inclination 15°	IK02	<i>protetto contro l'energia d'urto 0,2J</i> protected against collision energy
IP3X	<i>contro corpi estranei &gt;2,5 mm</i> protection against solid objects	IPX3	<i>protetto contro la caduta di gocce con inclinazione max 60°</i> protected against water drops max inclination 60°	IK03	<i>protetto contro l'energia d'urto 0,35J</i> protected against collision energy
IP4X	<i>contro corpi estranei &gt;1 mm</i> protection against solid objects	IPX4	<i>protetto contro spruzzi d'acqua</i> protected against sprinkling water	IK04	<i>protetto contro l'energia d'urto 0,5J</i> protected against collision energy
IP5X	<i>protezione da polvere</i> dust-protected	IPX5	<i>protetto contro getti d'acqua</i> protected against water jets	IK05	<i>protetto contro l'energia d'urto 0,7J</i> protected against collision energy
IP6X	<i>stagno alla polvere</i> dust-proof	IPX6	<i>protetto contro inondazioni</i> protected against flooding	IK06	<i>protetto contro l'energia d'urto 1J</i> protected against collision energy
		IPX7	<i>per breve immersione</i> protected against brief immersions	IK07	<i>protetto contro l'energia d'urto 2J</i> protected against collision energy
		IPX8	<i>per immersione prolungata</i> protected against long immersion	IK08	<i>protetto contro l'energia d'urto 5J</i> protected against collision energy
				IK09	<i>protetto contro l'energia d'urto 10J</i> protected against collision energy
				IK10	<i>protetto contro l'energia d'urto 20J</i> protected against collision energy

## legenda simboli symbols key

-  tavolo · table
-  terra · floor standing
-  soffitto · ceiling
-  parete · wall
-  sospensione · suspension
-  binario · track
-  incasso · recessed
-  scomparsa totale · fully concealed
-  segnaletica+emergenza · signalling system+emergency
-  portatili autoalimentati a batteria · portable self-powered with battery
-  sistemi · systems
-  palo · pole
-  paletto · bollard
-  seduta · sitting

 disponibile su · available on [Viabizzuno apflight www.Viabizzuno.com](http://www.Viabizzuno.com) Viabizzuno online

 classe I. solo isolamento fondamentale, le parti conduttrici accessibili sono collegate ad un conduttore di terra. messa a terra tassativa  
class I. only basic insulation, accessible conductors are earthed. earthing compulsory

 classe II. all'isolamento principale è aggiunto un secondo isolamento oppure ai due isolamenti è sostituito un isolamento rinforzato. messa a terra esclusa  
class II. basic insulation plus second insulation or both are replaced by reinforced insulation. earthing excluded

 classe III. alimentazione effettuata con bassissima tensione di sicurezza; sono escluse tensioni superiori a 50V-50Hz. messa a terra non prevista.  
class III. very low safety supply tension; not to be used over 50V-50Hz. earthing excluded.

 prodotto conforme alle direttive europee · produced in compliance with ec directives

 marchio di certificazione europea. certifica che il prodotto è conforme alle norme europee sulla sicurezza  
component approved for north american market and suitable to be used and approved as part of a more complex system

 componente certificato per il mercato nord americano idoneo ad essere utilizzato e valutato come parte di in un sistema più complesso  
component approved for north american market and suitable to be used and approved as part of a more complex system

 apparecchio di illuminazione approvato da kema · kema approved light fitting

 prodotto conforme agli standard presenti nel regno unito che regolamentano la sicurezza e la qualità dell'acqua · product complies with uk standards set out by water regulations

 apparecchio di illuminazione certificato secondo le normative vigenti in polonia che regolamentano i dispositivi di sicurezza antincendio  
certified light fitting according to the regulations about devices for fire safety in force in poland

 prodotto idoneo per essere commercializzato nel mercato cinese · product suitable for the china market

 prodotto finito idoneo per essere commercializzato nel mercato nord americano · listed product suitable for the north american market

 prodotto conforme alla legislazione vigente nel regno unito · produced in compliance with UK legislation

 apparecchio di illuminazione certificato per il mercato cinese  
light fitting certified for china market

-  *vetro opalino* · opal glass
-  *vetro sabbiato* · sanded glass
-  *vetro nero fumè* · black smoke glass
-  *vetro trasparente* · transparent glass
-  *vetro bianco latte* · white milk glass
-  *crystallo* · crystal
-  *policarbonato opalino* · opal polycarbonate diffuser
-  *carrabile* · drive over
-  *alimentatore incluso* · power supply included
-  *alimentatore escluso* · power supply not included
-  *alimentatore remoto incluso* · remote power supply included
-  *alimentatore elettronico con controllo intelligente incluso* · electronic power supply with smart control included
-  *alimentatore elettronico con controllo intelligente incluso, da installare remoto* · electronic power supply with smart control included, to be installed remotely
-  *alimentatore a spina incluso* · plug power supply included
-  *trasformatore incluso* · transformer included
-  *trasformatore escluso* · transformer not included
-  *kit di cablaggio* · wiring kit
-  *kit di cablaggio escluso* · wiring kit not included
-  *lampadina con sorgente elettronica led, ad incandescenza, alogena o fluorescente inclusa.*  
bulb with led electronic source, incandescent, halogen or fluorescent included.
-  *lampadina con sorgente elettronica led, ad incandescenza, alogena o fluorescente esclusa.*  
bulb with led electronic source, incandescent, halogen or fluorescent not included.
-  *propulsore dinamico n55 incluso* · included
-  *possibilità di combinazione tra interfaccia n55, propulsore dinamico n55 e lampadina n55* · possible combination between n55 interface, propulsore dinamico n55 and n55 bulb
-  *attenzione: sorgente luminosa led. non guardare mai direttamente a occhio nudo* · attention: led light source. never look straight without eye protection
-  *flicker free compatibile con fotocamere digitali* · flicker free digital camera friendly
- l.d.** *luce diretta* · direct light
- l.i.** *luce indiretta* · indirect light
- .d1** *dimmerazione 1-10V* · 1-10V dimmable
- .d2** *dimmerazione dali* · dimmable dali
- .SA** *kit luce + emergenza sempre accese. attenzione: non è possibile installare nelle cassaforme laterizio*  
light kit + permanently lit emergency lamp. please note: cannot be installed in brickwork housing
- .SE** *solo emergenza sempre accesa. attenzione: non è possibile installare nelle cassaforme laterizio*  
permanently lit emergency lamp only. please note: cannot be installed in brickwork housing
-  *peso netto* · net weight (kg)

# dca large incasso

david chipperfield 2010



**apparecchio di illuminazione da incasso per interni IP20.**  
realizzato in alluminio ossidato e verniciato a polvere. lo speciale sistema di alette regolabili in altezza permette il fissaggio su superfici di spessore da 10mm a 30mm.

**modelli:**

**dca large incasso fisso** diametro Ø210mm ingombro incasso 126mm con vetro albarino e ottica 54°,  
**dca large incasso orientabile** diametro Ø210mm ingombro incasso 135mm con ottiche intercambiabili 12° 24° 32° 47°, orientabile di 360° sull'asse verticale e 80° sull'asse orizzontale.

**cabato con sorgente elettronica 2700K, 3000K o 3000Vb K (progettato per il settore alta moda) Ra98 les9 fino a 30,2W 1560lm e les19 fino a 30,5W 3000lm.**

**alimentatore in corrente costante escluso, da installare remoto.**

**componenti: borchia tonda diametro Ø165mm, borchia quadrata 165x165mm.**

**accessori: borchia quadrata cieca 165x165mm, cassaforma a scomparsa totale, connettore femmina di alimentazione.**

**finiture: my bianco e nero55.**

**IP20 rated recessed light fitting for indoor use.**

**made of powder coated oxidised aluminium. the special system of height adjustable wings**  
**ables the installation on 10mm to 30mm thick surfaces.**

**versions:**

**dca large incasso fisso** diameter Ø210mm recessed of 126mm with albarino glass and 54° optic,

**dca large incasso orientabile** diameter Ø210mm recessed of 135mm with 12° 24° 32° 47° interchangeable optics, adjustable by 360° on the vertical axis and 80° on the horizontal axis.

**wired with 2700K, 3000K o 3000Vb K (designed for the high fashion industry) Ra98 led source with les 9 up to 30.2W 1560lm and les 19 up to 30.5W 3000lm.**

**constant current power supply not included, to be installed remotely.**

**components: round bezel diameter Ø165mm, square bezel 165x165mm.**

**accessories: blank square bezel 165x165mm, fully concealed housing, female feed connector.**  
**finishes: my bianco and nero55.**





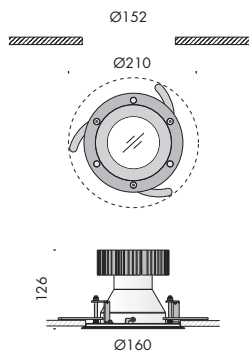

### dca large incasso fisso



**Vb6.027.54.27** my bianco 2700K 54° 1

**Vb6.027.64.27** nero55 2700K 54° 1

Ra	R9	ies tm-30		sdc	mA	V <sub>f</sub> (min)	lm	W	lm/W
98	98	Rf 96	Rg 103	step 1	350	27,6	1240	9,7	128
					500	27,9	1580	14,0	113
					700	28,4	2140	19,9	108
					1050	29,0	3000	30,5	98
xm000	les19	☉	Ta25 °C	vita media · average life	70000 h	L80	B10		

**Vb6.027.54.30** my bianco 3000K 54° 1

**Vb6.027.64.30** nero55 3000K 54° 1

Ra	R9	ies tm-30		sdc	mA	V <sub>f</sub> (min)	lm	W	lm/W
98	98	Rf 96	Rg 103	step 1	350	27,6	1240	9,7	128
					500	27,9	1580	14,0	113
					700	28,4	2140	19,9	108
					1050	29,0	3000	30,5	98
xm001	les19	☉	Ta25 °C	vita media · average life	70000 h	L80	B10		

**Vb6.027.54.30v** my bianco 3000VbK 54° 1

**Vb6.027.64.30v** nero55 3000VbK 54° 1

Ra	R9	ies tm-30		sdc	mA	V <sub>f</sub> (min)	lm	W	lm/W
98	98	Rf 93	Rg 106	step 1	350	27,6	1240	9,7	128
					500	27,9	1580	14,0	113
					700	28,4	2140	19,9	108
					1050	29,0	3000	30,5	98
xm007	les19	☉	Ta25 °C	vita media · average life	70000 h	L80	B10		

dca large incasso fisso 54°

gradi di apertura fascio luminoso  
beam's angle degrees

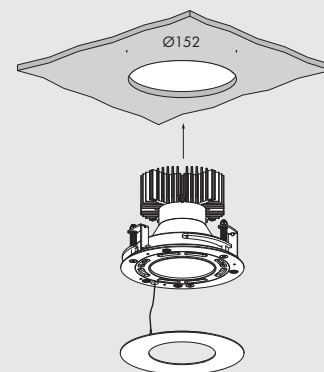
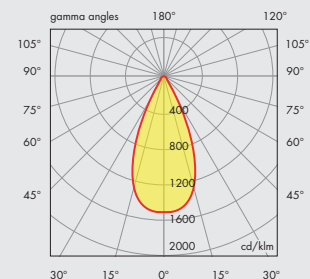
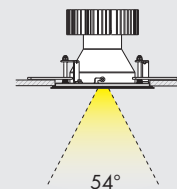

dca large incasso orientabile 12°

gradi di apertura fascio luminoso  
beam's angle degrees

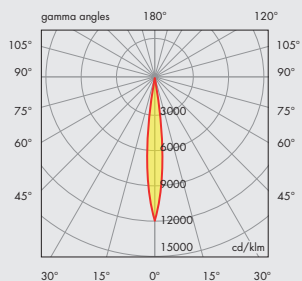
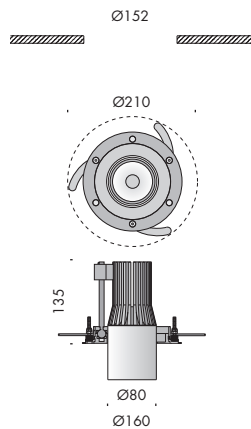
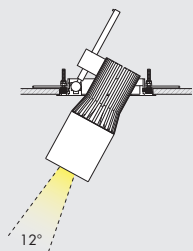

gradi di rotazione · rotation degrees

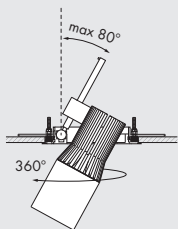

dca large incasso orientabile



**Vb6.027.01.27** my bianco 2700K 12° 1,5

**Vb6.027.11.27** nero55 2700K 12° 1,5

Ra	R9	ies tm-30		sdc	mA	V <sub>f (min)</sub>	lm	W	lm/W
98	98	Rf 96	Rg 103	step 1	500	27,1	800	13,6	59
					700	27,9	1110	19,5	57
					1050	28,8	1560	30,2	52
xe000	les9 ●	Ta25 °C		vita media · average life		70000 h	L80	B10	

**Vb6.027.01.30** my bianco 3000K 12° 1,5

**Vb6.027.11.30** nero55 3000K 12° 1,5

Ra	R9	ies tm-30		sdc	mA	V <sub>f (min)</sub>	lm	W	lm/W
98	98	Rf 96	Rg 103	step 1	500	27,1	800	13,6	59
					700	27,9	1110	19,5	57
					1050	28,8	1560	30,2	52
xe001	les9 ●	Ta25 °C		vita media · average life		70000 h	L80	B10	

**Vb6.027.01.30v** my bianco 3000VbK 12° 1,5

**Vb6.027.11.30v** nero55 3000VbK 12° 1,5

Ra	R9	ies tm-30		sdc	mA	V <sub>f (min)</sub>	lm	W	lm/W
98	98	Rf 93	Rg 106	step 1	500	27,1	800	13,6	59
					700	27,9	1110	19,5	57
					1050	28,8	1560	30,2	52
xe007	les9 ●	Ta25 °C		vita media · average life		70000 h	L80	B10	



dca large incasso orientabile 24°

gradi di apertura fascio luminoso  
beam's angle degrees

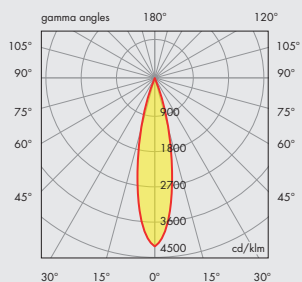
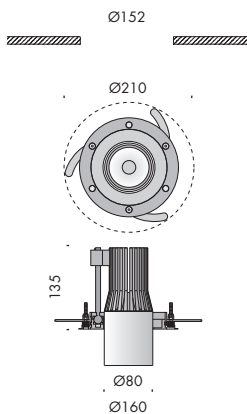
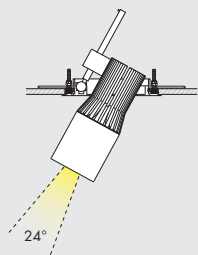

gradi di rotazione · rotation degrees

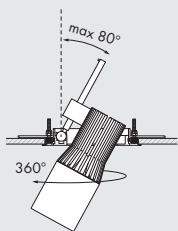

**dca large incasso orientabile**



**Vb6.027.02.27** my bianco 2700K 24° 1,5

**Vb6.027.12.27** nero55 2700K 24° 1,5

Ra	R9	ies tm-30		sdc	mA	V <sub>f</sub> (min)	lm	W	lm/W
98	98	Rf 96	Rg 103	step 1	350	27,6	1240	9,7	128
					500	27,9	1580	14,0	113
					700	28,4	2140	19,9	108
					1050	29,0	3000	30,5	98
xm000	les19 ●	Ta25 °C		vita media · average life		70000 h	L80 B10		

**Vb6.027.02.30** my bianco 3000K 24° 1,5

**Vb6.027.12.30** nero55 3000K 24° 1,5

Ra	R9	ies tm-30		sdc	mA	V <sub>f</sub> (min)	lm	W	lm/W
98	98	Rf 96	Rg 103	step 1	350	27,6	1240	9,7	128
					500	27,9	1580	14,0	113
					700	28,4	2140	19,9	108
					1050	29,0	3000	30,5	98
xm001	les19 ●	Ta25 °C		vita media · average life		70000 h	L80 B10		

**Vb6.027.02.30v** my bianco 3000VbK 24° 1,5

**Vb6.027.12.30v** nero55 3000VbK 24° 1,5

Ra	R9	ies tm-30		sdc	mA	V <sub>f</sub> (min)	lm	W	lm/W
98	98	Rf 93	Rg 106	step 1	350	27,6	1240	9,7	128
					500	27,9	1580	14,0	113
					700	28,4	2140	19,9	108
					1050	29,0	3000	30,5	98
xm007	les19 ●	Ta25 °C		vita media · average life		70000 h	L80 B10		

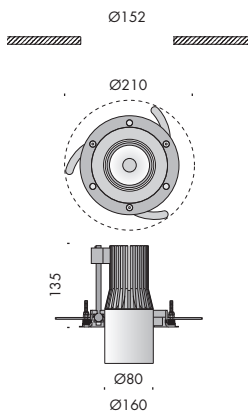

**Vb6.027.03.27** my bianco 2700K 32° 1,5

**Vb6.027.13.27** nero55 2700K 32° 1,5

Ra	R9	ies tm-30		sdc	mA	V <sub>f</sub> (min)	lm	W	lm/W
98	98	Rf 96	Rg 103	step 1	350	27,6	1240	9,7	128
					500	27,9	1580	14,0	113
					700	28,4	2140	19,9	108
					1050	29,0	3000	30,5	98
xm000	les19	Ta25 °C		vita media · average life	70000 h	L80	B10		

**Vb6.027.03.30** my bianco 3000K 32° 1,5

**Vb6.027.13.30** nero55 3000K 32° 1,5

Ra	R9	ies tm-30		sdc	mA	V <sub>f</sub> (min)	lm	W	lm/W
98	98	Rf 96	Rg 103	step 1	350	27,6	1240	9,7	128
					500	27,9	1580	14,0	113
					700	28,4	2140	19,9	108
					1050	29,0	3000	30,5	98
xm001	les19	Ta25 °C		vita media · average life	70000 h	L80	B10		

**Vb6.027.03.30v** my bianco 3000VbK 32° 1,5

**Vb6.027.13.30v** nero55 3000VbK 32° 1,5

Ra	R9	ies tm-30		sdc	mA	V <sub>f</sub> (min)	lm	W	lm/W
98	98	Rf 93	Rg 106	step 1	350	27,6	1240	9,7	128
					500	27,9	1580	14,0	113
					700	28,4	2140	19,9	108
					1050	29,0	3000	30,5	98
xm007	les19	Ta25 °C		vita media · average life	70000 h	L80	B10		

dca large incasso orientabile 32°

gradi di apertura fascio luminoso  
beam's angle degrees

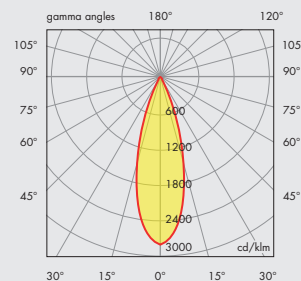
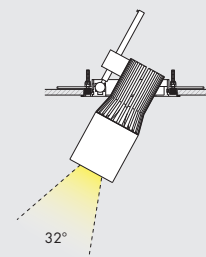

gradi di rotazione · rotation degrees

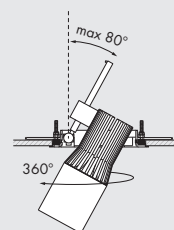

dca large incasso orientabile 47°

gradi di apertura fascio luminoso  
beam's angle degrees

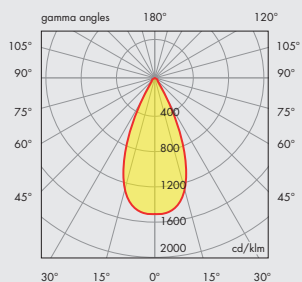
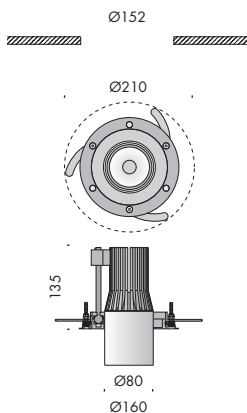
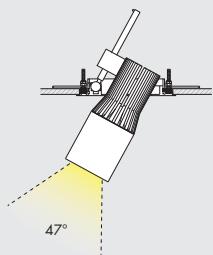

gradi di rotazione · rotation degrees

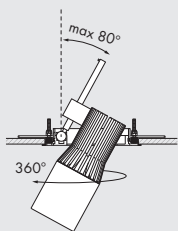

dca large incasso orientabile



**Vb6.027.04.27** my bianco 2700K 47° 1,5

**Vb6.027.14.27** nero55 2700K 47° 1,5

Ra	R9	ies tm-30		sdc	mA	V <sub>f (min)</sub>	lm	W	lm/W
98	98	Rf 96	Rg 103	step 1	350	27,6	1240	9,7	128
					500	27,9	1580	14,0	113
					700	28,4	2140	19,9	108
					1050	29,0	3000	30,5	98
xm000	les19 ●	Ta25 °C		vita media · average life		70000 h	L80 B10		

**Vb6.027.04.30** my bianco 3000K 47° 1,5

**Vb6.027.14.30** nero55 3000K 47° 1,5

Ra	R9	ies tm-30		sdc	mA	V <sub>f (min)</sub>	lm	W	lm/W
98	98	Rf 96	Rg 103	step 1	350	27,6	1240	9,7	128
					500	27,9	1580	14,0	113
					700	28,4	2140	19,9	108
					1050	29,0	3000	30,5	98
xm001	les19 ●	Ta25 °C		vita media · average life		70000 h	L80 B10		

**Vb6.027.04.30v** my bianco 3000VbK 47° 1,5

**Vb6.027.14.30v** nero55 3000VbK 47° 1,5

Ra	R9	ies tm-30		sdc	mA	V <sub>f (min)</sub>	lm	W	lm/W
98	98	Rf 93	Rg 106	step 1	350	27,6	1240	9,7	128
					500	27,9	1580	14,0	113
					700	28,4	2140	19,9	108
					1050	29,0	3000	30,5	98
xm007	les19 ●	Ta25 °C		vita media · average life		70000 h	L80 B10		



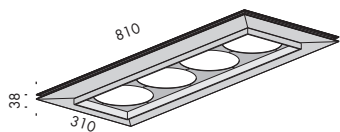
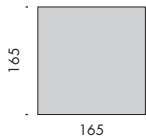
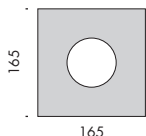
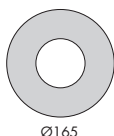
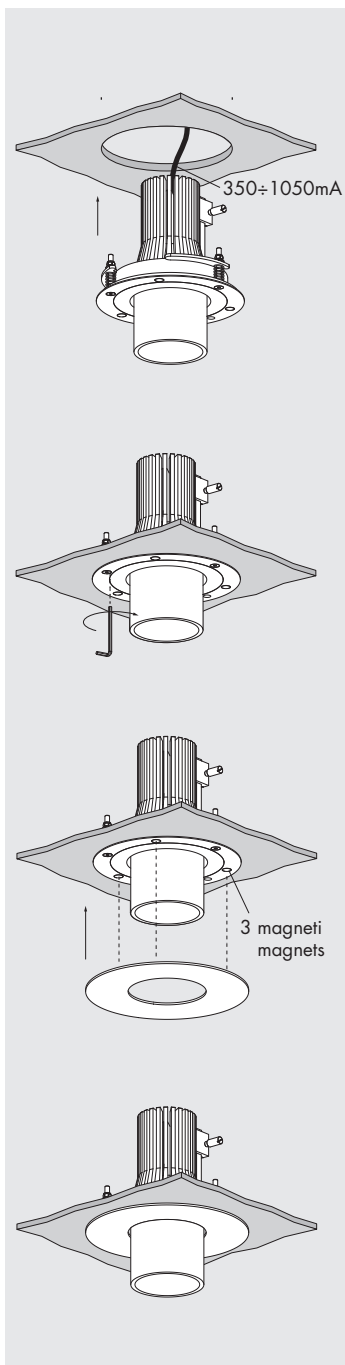

#### borchia tonda. round bezel.

★ UK CE i

**f9.027.83** nero55 0,2

**f9.027.85** my bianco 0,2

#### borchia quadrata. square bezel.

★ UK CE i

**f9.027.93** nero55 0,2

**f9.027.95** my bianco 0,2

#### borchia quadra cieca. square blank bezel.

★ UK CE i

**f9.215.96** my bianco 0,2

**f9.215.94** nero55 0,2

#### cassaforme scomparsa totale. fully concealed housings.

★ UK CE i

**f9.215.73** my bianco 2,5

**f9.215.72** nero55 2,5

#### dca large incasso ottiche. optics.

★ UK CE i

**Vb9.030.92** les19 ● 24° 0,1

**Vb9.030.93** les19 ● 32° 0,1

**Vb9.030.94** les19 ● 47° 0,1

#### accessori. accessories.

★ UK CE i

**f9.003** connettore femmina di alimentazione female feed connector 0,1



regolazione sistema di fissaggio  
fastening system adjustment

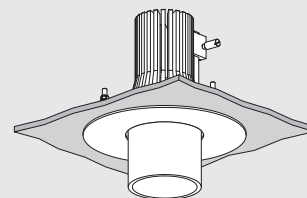
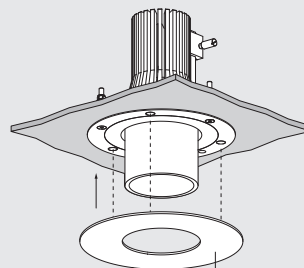
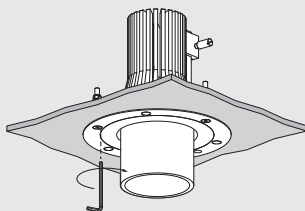
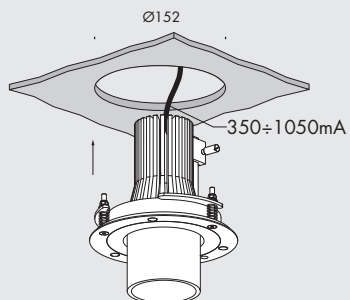
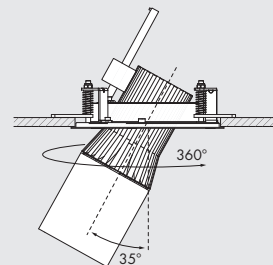
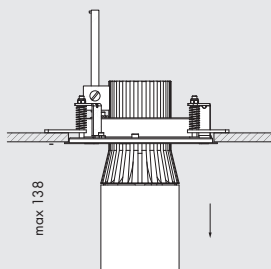
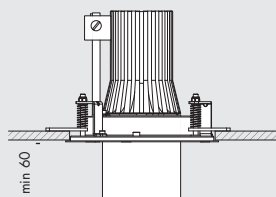
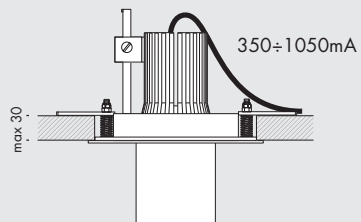
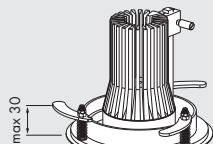
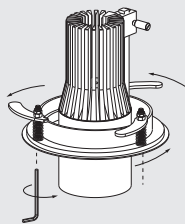
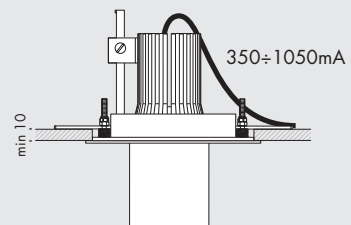
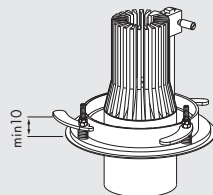
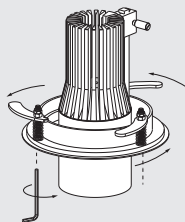

f9.027.83  
f9.027.85