

Viabizzuno strada principale della frazione di bizzuno in provincia di ravenna dove tra la casa del popolo e la parrocchia, al n°17, sono nato il ventuno luglio millenovecentocinquantacinque. da qui nasce il nome della fabbrica di produzione fondata nel millenovecentonovantaquattro rappresentata da uno spazio bianco attraversato da due linee. una verticale, rigorosa, essenziale, equilibrata: la luce per la luce; ed una inclinata, irriverente nello spazio, ironica, fuori dagli schemi: la luce per la forma. distinte ma complementari si fondono in un unico nome: Viabizzuno.

Viabizzuno is the name of the main road of the small village bizzuno located in the province of ravenna, where I was born on the twenty-first july nineteenfiftyfive at n°17, between the 'casa del popolo' and the local parish church. from here the name of the factory founded in nineteen ninety-four represented by a white space intersected by two lines. one vertical, well balanced, logical, essential: the light for the light. the other one dynamic, irreverent, ironic: the light for the form. separate and yet complementary they cast in the same name: Viabizzuno. marionanni

*i progetti rendono gli oggetti eterni,
le mode li corrompono, gli imbecilli li copiano
e li vendono agli ignoranti e ai deficienti.
noi progettiamo e lavoriamo per aiutare la luce
ad emozionarvi.*

*i frutti delle nostre idee e dei nostri progetti
sono protetti da brevetti
e/o modelli registrati
e/o da diritto d'autore.*

design makes objects timeless,
fashion corrupts them,
fools copy them and sell them to
ignorants and idiots.
we do projects and work to help light to bring
you true emotion.
the results of our ideas and our projects
are protected by patents
and/or registered models
and/or copyright.

al fine di offrire ai nostri clienti la massima qualità della luce utilizzando le più avanzate tecnologie, forti del nostro sapere artigiano costruito in italia, aggiorniamo costantemente i nostri apparecchi di illuminazione.

Viabizzuno si riserva il diritto di apportare ai propri modelli, senza nessun preavviso, qualsiasi modifica ritenesse opportuna. per dimensioni e codici fanno fede i nostri strumenti di lavoro www.Viabizzuno.com, Viacommerce@, Viabizzunoapplight e Viabizzunoonline.

in order to provide to our customers the maximum quality of light using the most advanced technologies, being strong of our artisan knowledge made in italy, we constantly update our lighting fixtures.

Viabizzuno reserves the right to make any modification, considered worthwhile, to its own models, without any notification. for valid dimensions and codes please consult our working tools www.Viabizzuno.com, Viacommerce@, Viabizzunoapplight and Viabizzunoonline.

lettura delle tabelle tecniche how to read technical tables

| | | | | | | | | | | |
|--------------------|---|---|---|---|---|------|---|----|----|--|
| XXXXXXXXXXXXXXXXXX | | | | | | | | | | |
| 230V 50-60Hz | | | | A | ⊕ | IP66 | | US | CE | |
| a | b | c | d | e | f | g | g | h | i | |

| | | | | | | | | | | |
|--------------------|--------|-------|---|-----|-----|------|--|----|----|--|
| XXXXXXXXXXXXXXXXXX | | | | | | | | | | |
| 230V 50-60Hz | | | | A | ⊕ | IP66 | | US | CE | |
| Vbx.xxx.xx | nero55 | 3000K | | 35W | 1,5 | | | | | |
| l | m | n | o | i | | | | | | |

| | | | |
|--------------------------------|------|----|--|
| componenti. components. | IK10 | CE | |
|--------------------------------|------|----|--|

| | | | |
|--------------------------------|------|----|--|
| accessori. accessories. | IK10 | CE | |
|--------------------------------|------|----|--|

| | | | | | | | | | |
|---|---|---|---|---|---|---|---|---|----|
| 1 | 2 | 3 | 4 | 5 | 6 | 7 | 8 | 9 | 10 |
|---|---|---|---|---|---|---|---|---|----|

| | | | | | | | | | |
|-------|-----|-----------|---------|---------------------------|---------|------|-----|------|---|
| Ra | R9 | ies tm/30 | | sdcM | Vf | lm/m | W/m | lm/W | |
| 95 | 90 | Rf 90 | Rg 98 | step 2 | 24 | 1200 | 13 | 92 | F |
| V0000 | 5,9 | | Ta25 °C | vita media · average life | 50000 h | L80 | B10 | | |

| | | | |
|----|----|----|----|
| 11 | 12 | 13 | 14 |
|----|----|----|----|

bandella tecnica. posizioni standard simbologie.
data plate. standard arrangement of symbols.

| | |
|---|---|
| a | nome apparecchio di illuminazione · light fitting name |
| b | tensione di alimentazione · supply rating (Volt) |
| c | frequenza di alimentazione · supply frequency (Hertz) |
| d | alimentatore incluso o escluso · power supply included or not included |
| e | classe di isolamento · insulation class |
| f | grado di protezione · protection degree |
| g | marchio di certificazione · safety and quality standards certification |
| h | conforme alle direttive europee produced in compliance with EC directives |
| i | peso netto · net weight (kg) |
| l | codice · code |
| m | finitura · finish |
| n | temperatura colore sorgente elettronica colour temperature led source (Kelvin) |
| o | potenza della sorgente · source power (Watt) |

componenti. identifica tutti gli elementi indispensabili per la corretta funzionalità e installazione dell'apparecchio di illuminazione.
components. includes all items that are essential to the correct operation and installation of the light fitting.















accessori. si riferisce alle ulteriori parti installabili sull'apparecchio.
accessories. refers to items that can be added to the light fitting.

| | |
|----|--|
| 1 | indice di resa cromatica · colour rendering index |
| 2 | indice di resa del rosso · red colour rendering index |
| 3 | Rf indice di fedeltà colore · colour fidelity index Rg indice di saturazione colore · color gamut index |
| 4 | step di macadam · macadam step |
| 5 | corrente di alimentazione · power supply current |
| 6 | tensione di alimentazione · power supply voltage |
| 7 | flusso luminoso · light flux |
| 8 | potenza della sorgente · source power |
| 9 | efficienza della sorgente · source efficiency |
| 10 | classe di efficienza energetica · efficiency class |
| 11 | codice sorgente elettronica Viabizzuno · Viabizzuno led source code |
| 12 | superficie emittente · light emitting surface (mm) |
| 13 | % flusso residuo a fine vita · end life % flux |
| 14 | % consentita sotto limite · allowed % under limit |

gradi di protezione protection degrees

| | | | | | |
|------|---|------|---|------|---|
| IP0X | <i>non protetto</i> no protection | IPX0 | <i>non protetto</i> no protection | | |
| IP1X | <i>contro corpi estranei >50 mm</i> protection against solid objects | IPX1 | <i>protetto contro la caduta verticale di gocce d'acqua</i> protected against water drops falling vertically | IK01 | <i>nessuna protezione</i> no protection |
| IP2X | <i>contro corpi estranei >12 mm</i> protection against solid objects | IPX2 | <i>protetto contro la caduta di gocce con inclinazione max 15°</i> protected against water drops max inclination 15° | IK02 | <i>protetto contro l'energia d'urto 0,2J</i> protected against collision energy |
| IP3X | <i>contro corpi estranei >2,5 mm</i> protection against solid objects | IPX3 | <i>protetto contro la caduta di gocce con inclinazione max 60°</i> protected against water drops max inclination 60° | IK03 | <i>protetto contro l'energia d'urto 0,35J</i> protected against collision energy |
| IP4X | <i>contro corpi estranei >1 mm</i> protection against solid objects | IPX4 | <i>protetto contro spruzzi d'acqua</i> protected against sprinkling water | IK04 | <i>protetto contro l'energia d'urto 0,5J</i> protected against collision energy |
| IP5X | <i>protezione da polvere</i> dust-protected | IPX5 | <i>protetto contro getti d'acqua</i> protected against water jets | IK05 | <i>protetto contro l'energia d'urto 0,7J</i> protected against collision energy |
| IP6X | <i>stagno alla polvere</i> dust-proof | IPX6 | <i>protetto contro inondazioni</i> protected against flooding | IK06 | <i>protetto contro l'energia d'urto 1J</i> protected against collision energy |
| | | IPX7 | <i>per breve immersione</i> protected against brief immersions | IK07 | <i>protetto contro l'energia d'urto 2J</i> protected against collision energy |
| | | IPX8 | <i>per immersione prolungata</i> protected against long immersion | IK08 | <i>protetto contro l'energia d'urto 5J</i> protected against collision energy |
| | | | | IK09 | <i>protetto contro l'energia d'urto 10J</i> protected against collision energy |
| | | | | IK10 | <i>protetto contro l'energia d'urto 20J</i> protected against collision energy |

legenda simboli symbols key

-  tavolo · table
-  terra · floor standing
-  soffitto · ceiling
-  parete · wall
-  sospensione · suspension
-  binario · track
-  incasso · recessed
-  scomparsa totale · fully concealed
-  segnaletica+emergenza · signalling system+emergency
-  portatili autoalimentati a batteria · portable self-powered with battery
-  sistemi · systems
-  palo · pole
-  paletto · bollard
-  seduta · sitting

 disponibile su · available on Viabizzuno.aplight www.Viabizzuno.com [Viabizzuno online](http://Viabizzuno.online)

 classe I. solo isolamento fondamentale, le parti conduttrici accessibili sono collegate ad un conduttore di terra. messa a terra tassativa
class I. only basic insulation, accessible conductors are earthed. earthing compulsory

 classe II. all'isolamento principale è aggiunto un secondo isolamento oppure ai due isolamenti è sostituito un isolamento rinforzato. messa a terra esclusa
class II. basic insulation plus second insulation or both are replaced by reinforced insulation. earthing excluded

 classe III. alimentazione effettuata con bassissima tensione di sicurezza; sono escluse tensioni superiori a 50V-50Hz. messa a terra non prevista.
class III. very low safety supply tension; not to be used over 50V-50Hz. earthing excluded.

 prodotto conforme alle direttive europee · produced in compliance with ec directives

 marchio di certificazione europea. certifica che il prodotto è conforme alle norme europee sulla sicurezza
component approved for north american market and suitable to be used and approved as part of a more complex system

 componente certificato per il mercato nord americano idoneo ad essere utilizzato e valutato come parte di in un sistema più complesso
component approved for north american market and suitable to be used and approved as part of a more complex system

 apparecchio di illuminazione approvato da kema · kema approved light fitting

 prodotto conforme agli standard presenti nel regno unito che regolamentano la sicurezza e la qualità dell'acqua · product complies with uk standards set out by water regulations

 apparecchio di illuminazione certificato secondo le normative vigenti in polonia che regolamentano i dispositivi di sicurezza antincendio
certified light fitting according to the regulations about devices for fire safety in force in poland

 prodotto idoneo per essere commercializzato nel mercato cinese · product suitable for the china market

 prodotto finito idoneo per essere commercializzato nel mercato nord americano · listed product suitable for the north american market

 prodotto conforme alla legislazione vigente nel regno unito · produced in compliance with UK legislation

 apparecchio di illuminazione certificato per il mercato cinese
light fitting certified for china market

-  *vetro opalino* · opal glass
-  *vetro sabbiato* · sanded glass
-  *vetro nero fumè* · black smoke glass
-  *vetro trasparente* · transparent glass
-  *vetro bianco latte* · white milk glass
-  *crystallo* · crystal
-  *policarbonato opalino* · opal polycarbonate diffuser
-  *carrabile* · drive over
-  *alimentatore incluso* · power supply included
-  *alimentatore escluso* · power supply not included
-  **AR** *alimentatore remoto incluso* · remote power supply included
-  **Ai** *alimentatore elettronico con controllo intelligente incluso* · electronic power supply with smart control included
-  **AiR** *alimentatore elettronico con controllo intelligente incluso, da installare remoto* · electronic power supply with smart control included, to be installed remotely
-  **AS** *alimentatore a spina incluso* · plug power supply included
-  **T** *trasformatore incluso* · transformer included
-  **T** *trasformatore escluso* · transformer not included
-  **K** *kit di cablaggio* · wiring kit
-  **K** *kit di cablaggio escluso* · wiring kit not included
-  **L** *lampadina con sorgente elettronica led, ad incandescenza, alogena o fluorescente inclusa.*
bulb with led electronic source, incandescent, halogen or fluorescent included.
-  **L** *lampadina con sorgente elettronica led, ad incandescenza, alogena o fluorescente esclusa.*
bulb with led electronic source, incandescent, halogen or fluorescent not included.
-  **Pr** *propulsore dinamico n55 incluso* · included
-  **Pr** *propulsore dinamico n55 escluso* · not included
-  **df** *diffusore incluso* · diffuser included
-  **df** *diffusore escluso* · diffuser not included
-  **?** *possibilità di combinazione tra interfaccia n55, propulsore dinamico n55 e lampadina n55* · possible combination between n55 interface, propulsore dinamico n55 and n55 bulb
-  **!** *attenzione: sorgente luminosa led. non guardare mai direttamente a occhio nudo* · attention: led light source. never look straight without eye protection
-  **ff** *flicker free compatibile con fotocamere digitali* · flicker free digital camera friendly
- l.d.** *luce diretta* · direct light
- l.i.** *luce indiretta* · indirect light
- .d1** *dimmerazione 1-10V* · 1-10V dimmable
- .d2** *dimmerazione dali* · dimmable dali
- .SA** *kit luce + emergenza sempre accese. attenzione: non è possibile installare nelle cassaforme laterizio*
light kit + permanently lit emergency lamp. please note: cannot be installed in brickwork housing
- .SE** *solo emergenza sempre accesa. attenzione: non è possibile installare nelle cassaforme laterizio*
permanently lit emergency lamp only. please note: cannot be installed in brickwork housing
-  **i** *peso netto* · net weight (kg)



apparecchio di illuminazione a binario, incasso, parete, soffitto, scomparsa totale e tavolo per interni IP20. realizzato in alluminio ossidato e verniciato a polvere, composto da un faretto diametro Ø37mm h.130mm o h.1164mm.

modelli:

droid binario con tige 128mm fissata all'adattatore, orientabile di 90° sull'asse orizzontale e 360° sull'asse verticale. alimentatore dali o casambi 240V 50-60Hz incluso;

droid incasso con faretto h.124mm, con tige 130mm fissata al rosone diametro Ø165mm, orientabile di 360° sull'asse verticale e 90° sull'asse orizzontale;

droid incasso 1200 con faretto h.1164mm, fissato ad un giunto orientabile di 360° sull'asse verticale e 25° sull'asse orizzontale; alimentatore in corrente costante escluso da installare remoto;

droid parete soffitto con faretto h.130mm e tige 128mm fissata al rosone diametro Ø165mm h.43mm, orientabile di 360° sull'asse verticale e di 90° sull'asse orizzontale. alimentatore dali switch 240V 50-60Hz incluso;

droid parete soffitto 1200 con faretto h.1164mm, fissato ad un giunto orientabile di 360° sull'asse verticale e di 25° sull'asse orizzontale. alimentatore dali switch 240V 50-60Hz incluso;

droid scomparsa totale con faretto h.130mm, orientabile di 360° sull'asse verticale e 90° sull'asse orizzontale;

droid scomparsa totale con faretto h.1164mm, orientabile di 360° sull'asse verticale e 25° sull'asse orizzontale, fissati con giunto di rotazione in cassaforma a scomparsa totale diametro Ø205mm h.148mm inclusa. alimentatore in corrente costante escluso da installare remoto;

droid tavolo con faretto h.130mm fissato su una base diametro Ø180mm tramite un sostegno snodato di 380mm, orientabile di 120° sull'asse verticale e 180° sull'asse orizzontale.

alimentatore 240V 50-60Hz a spina incluso.

cablato con sorgente elettronica 3000K Ra98 9,6W 964lm,

modello tavolo 3000K Ra98 8,1W 819lm.

ottica: 26°

finiture: my bianco e nero55.

droid binario è gestibile da device mobile tramite app Viascenario, il sistema di controllo wireless d'illuminazione Viabizzuno.



IP20-rated track, recessed, wall, ceiling, fully concealed and table light fitting for indoor use.

made of oxidised and powder coated aluminium, it consists of a Ø37mm h.130mm or h.1200mm spotlight.

versions:

droid binario with 128mm rod fixed to the adapter, adjustable by 90° on the horizontal axis and by 360° on the vertical axis. 240V 50-60Hz dali switch power supply included;

droid incasso with h.124mm spotlight, with 130mm rod fixed to the Ø165mm ceiling rose, adjustable by 360° on the vertical axis and by 90° on the horizontal axis;

droid incasso 1200 with h.1164mm spotlight, fixed to a joint adjustable by 360° on the vertical axis and by 25° on the horizontal axis. constant current power supply not included, to be installed remotely;

droid parete soffitto with h.130mm spotlight and 128mm rod fixed to the Ø165mm h.43mm rose, adjustable by 360° on the vertical axis and by 90° on the horizontal axis. 240V 50-60Hz dali switch power supply included;

droid parete soffitto 1200 with h.1164mm spotlight, fixed to a joint adjustable by 360° on the vertical axis and by 25° on the horizontal axis. 240V 50-60Hz dali switch power supply included;

droid scomparsa totale with h.130mm spotlight, adjustable by 360° on the vertical axis and by 90° on the horizontal axis;

droid scomparsa totale with h.1164mm spotlight, adjustable by 360° on the vertical axis and by 25° on the horizontal axis, fixed by means of a rotating joint to a Ø205mm h.148mm fully concealed housing included. constant current power supply not included, to be installed remotely;

droid tavolo with h.130mm spotlight fixed on a Ø180mm base by means of a 380mm articulated support, adjustable by 120° on the vertical axis and by 180° on the horizontal axis. 240V 50-60Hz power supply with plug included.

wired with 3000K Ra98 led source 9,6W 964lm, , 3000K Ra98 8.1W 819lm table version.

optic: 26°

finishes: my bianco and nero55.

droid binario is manageable from mobile devices via Viascenario app, Viabizzuno's wireless lighting control system.



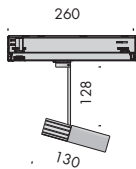

| droid binario | | 240V 50-60Hz | IP20 | | | | | |
|-------------------------|--------------------|--------------|-------|-----|-----|--|--|--|
| Vb7.572.51.27.d2 | my bianco · bianco | dali | 2700K | 26° | 1,3 | | | |
| Vb7.572.52.27.d2 | nero 55 · nero | dali | 2700K | 26° | 1,3 | | | |
| Vb7.572.51.27.d4 | my bianco · bianco | casambi | 2700K | 26° | 1,3 | | | |
| Vb7.572.52.27.d4 | nero 55 · nero | casambi | 2700K | 26° | 1,3 | | | |

| Ra | R9 | ies tm-30 | | sdc | mA | V _{f(min)} | lm | W | lm/W |
|-------|------|-----------|--------|---------------------------|-----|---------------------|---------|-----|------|
| 98 | 95 | Rf 95 | Rg 100 | step 2 | 600 | 16,4 | 895 | 9,8 | 91 |
| cd040 | les6 | Ta25 °C | | vita media · average life | | 50000 h | L70 B10 | | |

| | | | | | | | | |
|-------------------------|--------------------|---------|-------|-----|-----|--|--|--|
| Vb7.572.51.30.d2 | my bianco · bianco | dali | 3000K | 26° | 1,3 | | | |
| Vb7.572.52.30.d2 | nero 55 · nero | dali | 3000K | 26° | 1,3 | | | |
| Vb7.572.51.30.d4 | my bianco · bianco | casambi | 3000K | 26° | 1,3 | | | |
| Vb7.572.52.30.d4 | nero 55 · nero | casambi | 3000K | 26° | 1,3 | | | |

| Ra | R9 | ies tm-30 | | sdc | mA | V _{f(min)} | lm | W | lm/W |
|-------|------|-----------|--------|---------------------------|-----|---------------------|---------|-----|------|
| 98 | 95 | Rf 95 | Rg 100 | step 2 | 600 | 16,4 | 964 | 9,8 | 98 |
| cd041 | les6 | Ta25 °C | | vita media · average life | | 50000 h | L80 B10 | | |



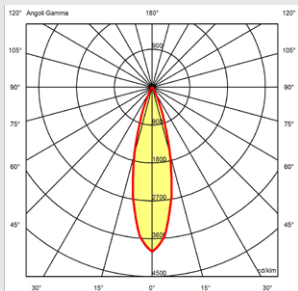
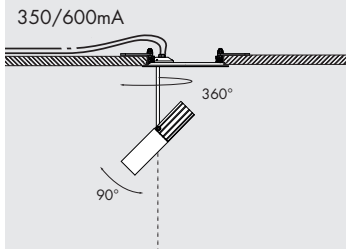
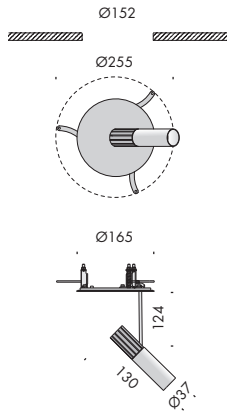
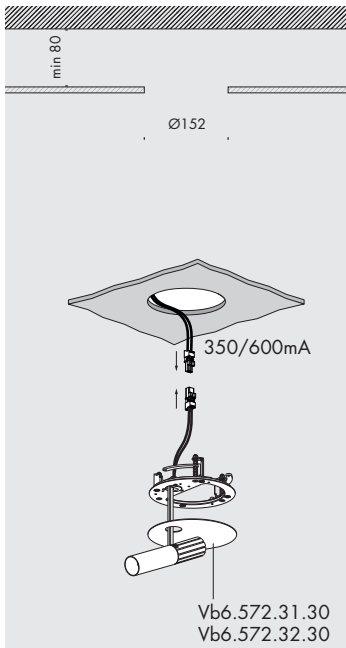

droid incasso



IP20



Vb6.572.31.30 my bianco

3000K 26° 1,3

Vb6.572.32.30 nero55

3000K 26° 1,3

| Ra | R9 | ies tm-30 | | sdc | mA | V _{f(min)} | lm | W | lm/W |
|-------|------|-----------|--------|---------------------------|-----|---------------------|---------|-----|------|
| 98 | 95 | Rf 95 | Rg 100 | step 2 | 350 | 16,0 | 586 | 5,6 | 105 |
| | | | | | 600 | 16,4 | 964 | 9,8 | 98 |
| cd041 | les6 | Ta25 °C | | vita media · average life | | 50000 h | L80 B10 | | |



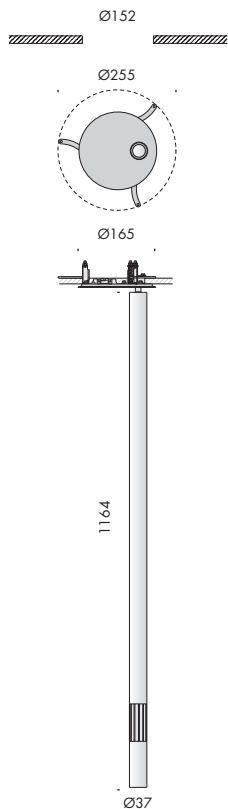
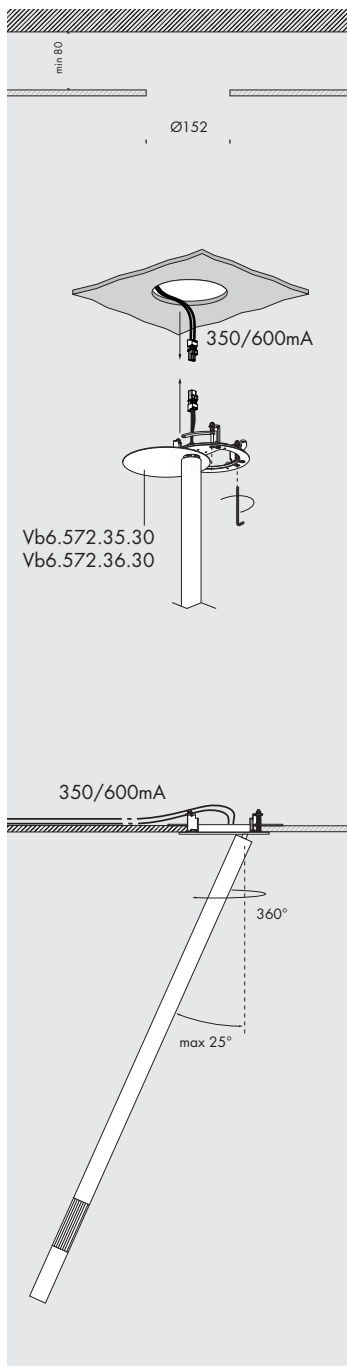

droid incasso 1200



IP20



Vb6.572.35.30 my bianco

3000K 26° 3

Vb6.572.36.30 nero55

3000K 26° 3

| Ra | R9 | ies tm-30 | | sdc | mA | V _{f(min)} | lm | W | lm/W |
|-------|------|-----------|--------|---------------------------|-----|---------------------|---------|-----|------|
| 98 | 95 | Rf 95 | Rg 100 | step 2 | 350 | 16,0 | 586 | 5,6 | 105 |
| | | | | | 600 | 16,4 | 964 | 9,8 | 98 |
| cd041 | les6 | Ta25 °C | | vita media · average life | | 50000 h | L80 B10 | | |



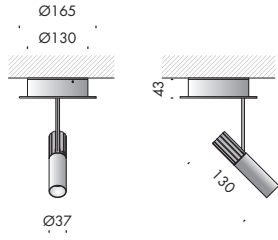

droid parete soffitto 240V 50-60Hz

Vb6.572.21.30.d2 my bianco dali switch 3000K 26° 1,3

Vb6.572.22.30.d2 nero55 dali switch 3000K 26° 1,3

| Ra | R9 | ies tm-30 | | sdc | mA | V _{f(min)} | lm | W | lm/W |
|-------|------|-----------|--------|---------------------------|-----|---------------------|---------|-----|------|
| 98 | 95 | Rf 95 | Rg 100 | step 2 | 600 | 16,4 | 964 | 9,8 | 98 |
| cd041 | les6 | Ta25 °C | | vita media · average life | | 50000 h | L80 B10 | | |

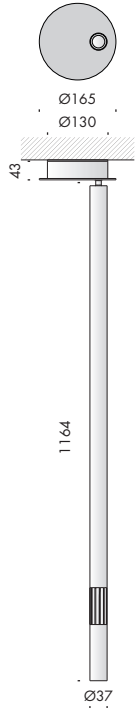

droid parete soffitto 1200 240V 50-60Hz

Vb6.572.25.30.d2 my bianco dali switch 3000K 26° 3

Vb6.572.26.30.d2 nero55 dali switch 3000K 26° 3

| Ra | R9 | ies tm-30 | | sdc | mA | V _{f(min)} | lm | W | lm/W |
|-------|------|-----------|--------|---------------------------|-----|---------------------|---------|-----|------|
| 98 | 95 | Rf 95 | Rg 100 | step 2 | 600 | 16,4 | 964 | 9,8 | 98 |
| cd041 | les6 | Ta25 °C | | vita media · average life | | 50000 h | L80 B10 | | |



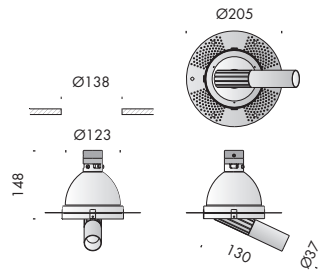
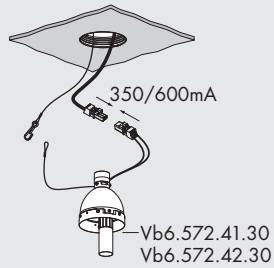
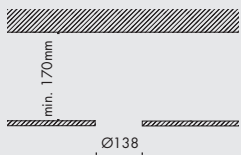

droid scomparsa totale



IP20



Vb6.572.41.30 my bianco

3000K 26° 1,3

Vb6.572.42.30 nero55

3000K 26° 1,3

| Ra | R9 | ies tm-30 | | sdc | mA | V _{f(min)} | lm | W | lm/W |
|-------|------|-----------|--------|---------------------------|---------|---------------------|---------|-----|------|
| 98 | 95 | Rf 95 | Rg 100 | step 2 | 350 | 16,0 | 586 | 5,6 | 105 |
| | | | | | 600 | 16,4 | 964 | 9,8 | 98 |
| cd041 | les6 | Ta25 °C | | vita media · average life | 50000 h | | L80 B10 | | |

Vb6.572.41.30
Vb6.572.42.30

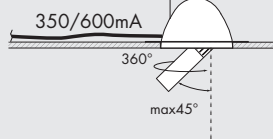

Vb6.572.45.30
Vb6.572.46.30

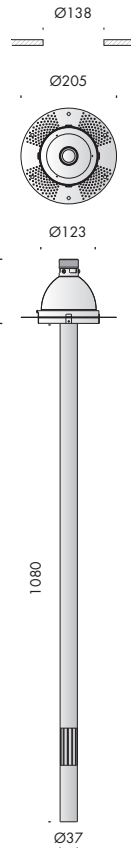
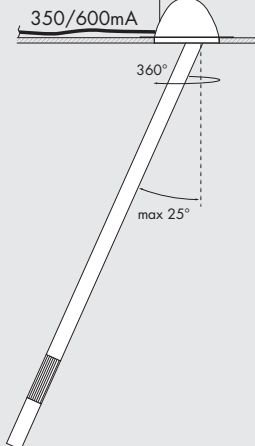

droid scomparsa totale 1200



IP20



Vb6.572.45.30 my bianco

3000K 26° 3

Vb6.572.46.30 nero55

3000K 26° 3

| Ra | R9 | ies tm-30 | | sdc | mA | V _{f(min)} | lm | W | lm/W |
|-------|------|-----------|--------|---------------------------|---------|---------------------|---------|-----|------|
| 98 | 95 | Rf 95 | Rg 100 | step 2 | 350 | 16,0 | 586 | 5,6 | 105 |
| | | | | | 600 | 16,4 | 964 | 9,8 | 98 |
| cd041 | les6 | Ta25 °C | | vita media · average life | 50000 h | | L80 B10 | | |

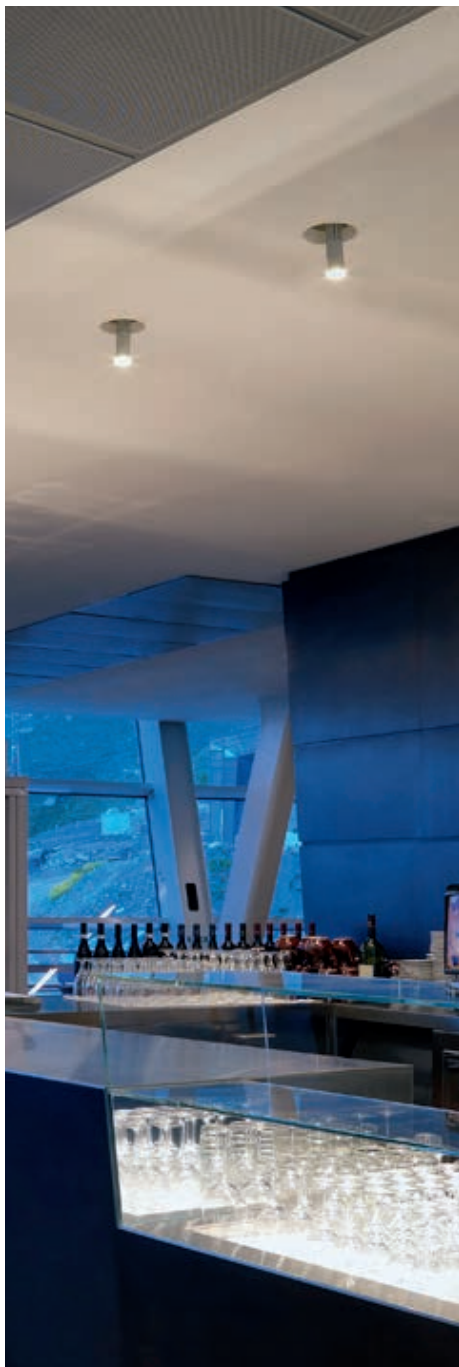

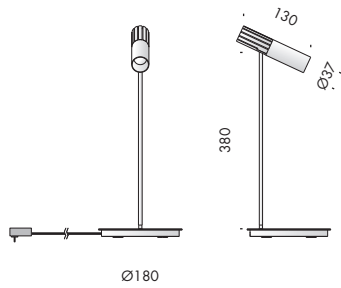

droid tavolo **240V 50-60Hz** **AS** **IP20** **UK** **CE** **i**

Vb2.572.01.30 my bianco 3000K 26° 3

Vb2.572.02.30 nero55 3000K 26° 3

| Ra | R9 | ies tm-30 | | sdc | mA | V _f (min) | lm | W | lm/W |
|-------|------|-----------|--------|---------------------------|-----|----------------------|---------|-----|------|
| 98 | 95 | Rf 95 | Rg 100 | step 2 | 500 | 16,2 | 819 | 8,1 | 101 |
| cd041 | les6 | Ta25 °C | | vita media · average life | | 50000 h | L70 B10 | | |

