

*Viabizzuno strada principale della frazione di bizzuno in provincia di ravenna dove tra la casa del popolo e la parrocchia, al n°17, sono nato il ventuno luglio millenovecentocinquantacinque. da qui nasce il nome della fabbrica di produzione fondata nel millenovecentonovantaquattro rappresentata da uno spazio bianco attraversato da due linee. una verticale, rigorosa, essenziale, equilibrata: la luce per la luce; ed una inclinata, irriverente nello spazio, ironica, fuori dagli schemi: la luce per la forma. distinte ma complementari si fondono in un unico nome: Viabizzuno.*

Viabizzuno is the name of the main road of the small village bizzuno located in the province of ravenna, where I was born on the twenty-first july nineteenfiftyfive at n°17, between the 'casa del popolo' and the local parish church. from here the name of the factory founded in nineteen ninety-four represented by a white space intersected by two lines. one vertical, well balanced, logical, essential: the light for the light. the other one dynamic, irreverent, ironic: the light for the form. separate and yet complementary they cast in the same name: Viabizzuno. mario nanni

*i progetti rendono gli oggetti eterni,  
le mode li corrompono, gli imbecilli li copiano  
e li vendono agli ignoranti e ai deficienti.  
noi progettiamo e lavoriamo per aiutare la luce  
ad emozionarvi.*

*i frutti delle nostre idee e dei nostri progetti  
sono protetti da brevetti  
e/o modelli registrati  
e/o da diritto d'autore.*

*design makes objects timeless,  
fashion corrupts them,  
fools copy them and sell them to  
ignorants and idiots.  
we do projects and work to help light to bring  
you true emotion.  
the results of our ideas and our projects  
are protected by patents  
and/or registered models  
and/or copyright.*

*al fine di offrire ai nostri clienti la massima qualità della luce utilizzando le più avanzate tecnologie, forti del nostro sapere artigiano costruito in italia, aggiorniamo costantemente i nostri apparecchi di illuminazione.*

*Viabizzuno si riserva il diritto di apportare ai propri modelli, senza nessun preavviso, qualsiasi modifica ritenesse opportuna. per dimensioni e codici fanno fede i nostri strumenti di lavoro [www.Viabizzuno.com](http://www.Viabizzuno.com), [Viacommerce@](mailto:Viacommerce@viabizzuno.com), [Viabizzunoapplight](http://Viabizzunoapplight.com) e [Viabizzunoonline](http://Viabizzunoonline.com).*

*in order to provide to our customers the maximum quality of light using the most advanced technologies, being strong of our artisan knowledge made in italy, we constantly update our lighting fixtures.*

*Viabizzuno reserves the right to make any modification, considered worthwhile, to its own models, without any notification. for valid dimensions and codes please consult our working tools [www.Viabizzuno.com](http://www.Viabizzuno.com), [Viacommerce@](mailto:Viacommerce@viabizzuno.com), [Viabizzunoapplight](http://Viabizzunoapplight.com) and [Viabizzunoonline](http://Viabizzunoonline.com).*

# lettura delle tabelle tecniche how to read technical tables

XXXXXXXXXXXXXXXXXX										
230V 50-60Hz				A	⊕	IP66	⚡	eFu us	CE	i
a	b	c	d	e	f	g	g	h	i	

XXXXXXXXXXXXXXXXXX										
230V 50-60Hz				A	⊕	IP66	⚡	eFu us	CE	i
Vbx.xxx.xx	nero55	3000K		35W	1,5					
l	m	n	o	i						

<b>componenti. components.</b>	<b>IK10</b>	CE	i
--------------------------------	-------------	----	---

<b>accessori. accessories.</b>	<b>IK10</b>	CE	i
--------------------------------	-------------	----	---

1	2	3	4	5	6	7	8	9	10	
Ra	R9	ies tm-30		sdcM	mA	V <sub>f (min)</sub>	lm	W	lm/W	⚡
98	98	Rf 96	Rg 103	step 1	350	27,6	1240	9,7	128	A++
xm000	les19	Ta25 °C		vita media · average life	500	27,9	1580	14,0	113	A+
70000 h	L80	B10								
11	12	13	14							

bandella tecnica. posizioni standard simbologie.  
data plate. standard arrangement of symbols.

a	nome apparecchio di illuminazione · light fitting name
b	tensione di alimentazione · supply rating (Volt)
c	frequenza di alimentazione · supply frequency (Hertz)
d	alimentatore incluso o escluso · power supply included or not included
e	classe di isolamento · insulation class
f	grado di protezione · protection degree
g	marchio di certificazione · safety and quality standards certification
h	conforme alle direttive europee produced in compliance with EC directives
i	peso netto · net weight (kg)
l	codice · code
m	finitura · finish
n	temperatura colore sorgente elettronica colour temperature led source (Kelvin)
o	potenza della sorgente · source power (Watt)

componenti. identifica tutti gli elementi indispensabili per la corretta funzionalità e installazione dell'apparecchio di illuminazione.  
components. includes all items that are essential to the correct operation and installation of the light fitting.

accessori. si riferisce alle ulteriori parti installabili sull'apparecchio.  
accessories. refers to items that can be added to the light fitting.

1	indice di resa cromatica · colour rendering index
2	indice di resa del rosso · red colour rendering index
3	Rf indice di fedeltà colore · colour fidelity index Rg indice di saturazione colore · color gamut index
4	step di macadam · macadam step
5	corrente di alimentazione · power supply current
6	tensione di alimentazione · power supply voltage
7	flusso luminoso · light flux
8	potenza della sorgente · source power
9	efficienza della sorgente · source efficiency
10	classe di efficienza energetica · efficiency class
11	codice sorgente elettronica Viabizzuno · Viabizzuno led source code
12	superficie emittente · light emitting surface (mm)
13	% flusso residuo a fine vita · end life % flux
14	% consentita sotto limite · allowed % under limit

## gradi di protezione protection degrees

IP0X	<i>non protetto</i> no protection	IPX0	<i>non protetto</i> no protection	IK01	<i>nessuna protezione</i> no protection
IP1X	<i>contro corpi estranei &gt;50 mm</i> protection against solid objects	IPX1	<i>protetto contro la caduta verticale di gocce d'acqua</i> protected against water drops falling vertically	IK01	<i>protetto contro l'energia d'urto 0,15J</i> protected against collision energy
IP2X	<i>contro corpi estranei &gt;12 mm</i> protection against solid objects	IPX2	<i>protetto contro la caduta di gocce con inclinazione max 15°</i> protected against water drops max inclination 15°	IK02	<i>protetto contro l'energia d'urto 0,2J</i> protected against collision energy
IP3X	<i>contro corpi estranei &gt;2,5 mm</i> protection against solid objects	IPX3	<i>protetto contro la caduta di gocce con inclinazione max 60°</i> protected against water drops max inclination 60°	IK03	<i>protetto contro l'energia d'urto 0,35J</i> protected against collision energy
IP4X	<i>contro corpi estranei &gt;1 mm</i> protection against solid objects	IPX4	<i>protetto contro spruzzi d'acqua</i> protected against sprinkling water	IK04	<i>protetto contro l'energia d'urto 0,5J</i> protected against collision energy
IP5X	<i>protezione da polvere</i> dust-protected	IPX5	<i>protetto contro getti d'acqua</i> protected against water jets	IK05	<i>protetto contro l'energia d'urto 0,7J</i> protected against collision energy
IP6X	<i>stagno alla polvere</i> dust-proof	IPX6	<i>protetto contro inondazioni</i> protected against flooding	IK06	<i>protetto contro l'energia d'urto 1J</i> protected against collision energy
		IPX7	<i>per breve immersione</i> protected against brief immersions	IK07	<i>protetto contro l'energia d'urto 2J</i> protected against collision energy
		IPX8	<i>per immersione prolungata</i> protected against long immersion	IK08	<i>protetto contro l'energia d'urto 5J</i> protected against collision energy
				IK09	<i>protetto contro l'energia d'urto 10J</i> protected against collision energy
				IK10	<i>protetto contro l'energia d'urto 20J</i> protected against collision energy

## legenda simboli symbols key



tavolo · table



terra · floor standing



soffitto · ceiling



parete · wall



sospensione · suspension



binario · track



incasso · recessed



scomparsa totale · fully concealed



segnalatica+emergenza · signalling system+emergency



portatili autoalimentati a batteria · portable self-powered with battery



sistemi · systems



palo · pole



paletto · bollard



seduta · sitting



disponibile su · available on [Viabizzuno.aplight](http://Viabizzuno.aplight) [www.Viabizzuno.com](http://www.Viabizzuno.com) [Viabizzuno online](http://Viabizzuno.online)



classe I. solo isolamento fondamentale, le parti conduttrici accessibili sono collegate ad un conduttore di terra. messa a terra tassativa  
class I. only basic insulation, accessible conductors are earthed. earthing compulsory



classe II. all'isolamento principale è aggiunto un secondo isolamento oppure ai due isolamenti è sostituito un isolamento rinforzato. messa a terra esclusa  
class II. basic insulation plus second insulation or both are replaced by reinforced insulation. earthing excluded



classe III. alimentazione effettuata con bassissima tensione di sicurezza; sono escluse tensioni superiori a 50V-50Hz. messa a terra non prevista.  
class III. very low safety supply tension; not to be used over 50V-50Hz. earthing excluded.



prodotto conforme alle direttive europee · produced in compliance with ec directives



marchio di certificazione europea. certifica che il prodotto è conforme alle norme europee sulla sicurezza  
component approved for north american market and suitable to be used and approved as part of a more complex system



componente certificato per il mercato nord americano idoneo ad essere utilizzato e valutato come parte di un sistema più complesso  
component approved for north american market and suitable to be used and approved as part of a more complex system



apparecchio di illuminazione approvato da kema · kema approved light fitting



prodotto conforme agli standard presenti nel regno unito che regolamentano la sicurezza e la qualità dell'acqua · product complies with uk standards set out by water regulations



apparecchio di illuminazione certificato secondo le normative vigenti in polonia che regolamentano i dispositivi di sicurezza antincendio  
certified light fitting according to the regulations about devices for fire safety in force in poland



prodotto idoneo per essere commercializzato nel mercato cinese · product suitable for the china market



prodotto finito idoneo per essere commercializzato nel mercato nord americano · listed product suitable for the north american market



apparecchio di illuminazione in corso di certificazione per essere commercializzato nel mercato nord americano  
light fitting undergoing certification to be marketed in the north american market

**IP20** grado di protezione · protection degree

 vetro opalino · opal glass

 vetro sabbiato · sanded glass

 vetro nero fumè · black smoke glass

 vetro trasparente · transparent glass

 vetro bianco latte · white milk glass

 cristallo · crystal

 policarbonato opalino · opal polycarbonate diffuser

 carrabile · drive over

 alimentatore incluso · power supply included

 alimentatore escluso · power supply not included

**AR** alimentatore remoto incluso · remote power supply included

**Ai** alimentatore elettronico con controllo intelligente incluso · electronic power supply with smart control included

**AiR** alimentatore elettronico con controllo intelligente incluso, da installare remoto · electronic power supply with smart control included, to be installed remotely

**AS** alimentatore a spina incluso · plug power supply included

**T** trasformatore incluso · transformer included

 trasformatore escluso · transformer not included

**K** kit di cablaggio · wiring kit

 kit di cablaggio escluso · wiring kit not included

**L** lampadina con sorgente elettronica led, ad incandescenza, alogena o fluorescente inclusa.  
bulb with led electronic source, incandescent, halogen or fluorescent included.

 lampadina con sorgente elettronica led, ad incandescenza, alogena o fluorescente esclusa.  
bulb with led electronic source, incandescent, halogen or fluorescent not included.

**Pr** propulsore dinamico n55 incluso · included

 possibilità di combinazione tra interfaccia n55, propulsore dinamico n55 e lampadina n55 · possible combination between n55 interface, propulsore dinamico n55 and n55 bulb

 attenzione: sorgente luminosa led. non guardare mai direttamente a occhio nudo · attention: led light source. never look straight without eye protection

**ff** flicker free compatibile con fotocamere digitali · flicker free digital camera friendly

**l.d.** luce diretta · direct light

**l.i.** luce indiretta · indirect light

**.d1** dimmerazione 1-10V · 1-10V dimmable

**.d2** dimmerazione dali · dimmable dali

**.SA** kit luce + emergenza sempre accese. attenzione: non è possibile installare nelle cassaforme laterizio  
light kit + permanently lit emergency lamp. please note: cannot be installed in brickwork housing

**.SE** solo emergenza sempre accesa. attenzione: non è possibile installare nelle cassaforme laterizio  
permanently lit emergency lamp only. please note: cannot be installed in brickwork housing

**i** peso netto · net weight (kg)

# **lampada quadra** " ...l'ho voluta di forma quadrata, perfetta. " ag fronzoni 1962



**apparecchio di illuminazione a parete o soffitto per interni IP20.  
costituito da schermo in acciaio 220x220mm e struttura di supporto 110mm.  
cablato con sorgente elettronica 2700K Ra98 fino a 16,8W 1714lm  
o 3000K Ra98 fino a 16,8W 1810lm,  
emette luce diffusa indiretta e crea un punto di luce sulla parte a vista grazie ad un  
microforo quadrato centrale.  
alimentatore 240V 50-60Hz a corrente costante escluso, da installare remotamente.  
finiture: my bianco, nero55, inox lucido.**

**IP20 rated wall or ceiling light fitting for indoor use.  
consisting of a 220x220mm steel shield and 110mm support.  
wired with 2700K Ra98 up to 16,8W 1714lm  
or 3000K Ra98 up to 16,8W 1810lm led source,  
it emits diffuse indirect light and creates a spot light on the exposed part thanks to a  
central square microhole.  
240V 50-60Hz constant current power supply not included, to be installed remotely.  
finishes: my bianco, nero55, polished stainless steel.**

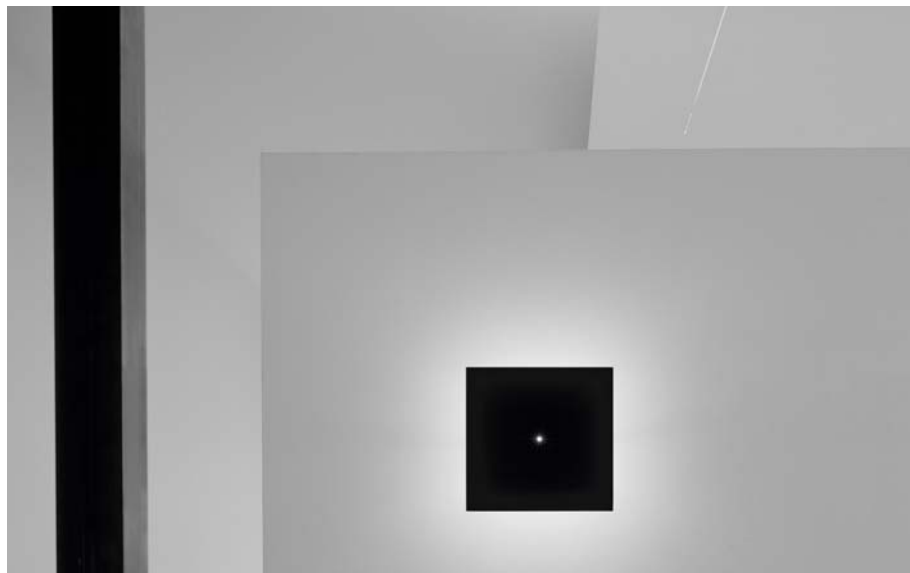
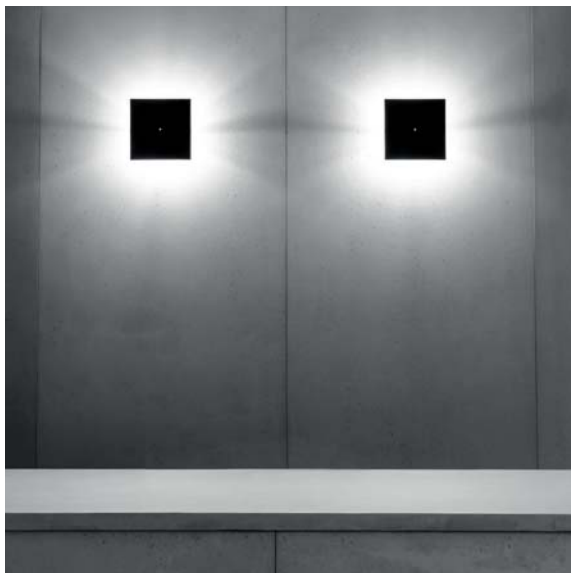



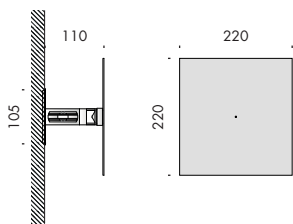





**lampada quadra**   **IP20**   

<b>Vb6.115.01.27</b>	my bianco	2700K	1,5
<b>Vb6.115.02.27</b>	nero55	2700K	1,5
<b>Vb6.115.03.27</b>	inox lucido · polished stainless steel	2700K	1,5

Ra	R9	ies tm-30		sdcn	mA	V <sub>f (min)</sub>	lm	W	lm/W	
98	90	Rf 93	Rg 99	step 2	350	32,8	1233	11,5	108	<b>A+</b>
					500	33,6	1714	16,8	102	<b>A+</b>
ce060	les12 ●	Ta25 °C		vita media · average life		50000 h	L80		B10	

<b>Vb6.115.01.30</b>	my bianco	3000K	1,5
<b>Vb6.115.02.30</b>	nero55	3000K	1,5
<b>Vb6.115.03.30</b>	inox lucido · polished stainless steel	3000K	1,5

Ra	R9	ies tm-30		sdcn	mA	V <sub>f (min)</sub>	lm	W	lm/W	
98	90	Rf 93	Rg 99	step 2	350	32,8	1302	11,5	114	<b>A+</b>
					500	33,6	1810	16,8	108	<b>A+</b>
ce061	les12 ●	Ta25 °C		vita media · average life		50000 h	L80		B10	

**alimentatori. power supplies.** **240V 50-60Hz**  **IP20**  

<b>t4.382.350</b>	240V/30-42V	15W	350mA	0,2
<b>t4.382.500</b>	240V/30-42V	21W	500mA	0,2



installazione con alimentatore remoto · installation with remote power supply

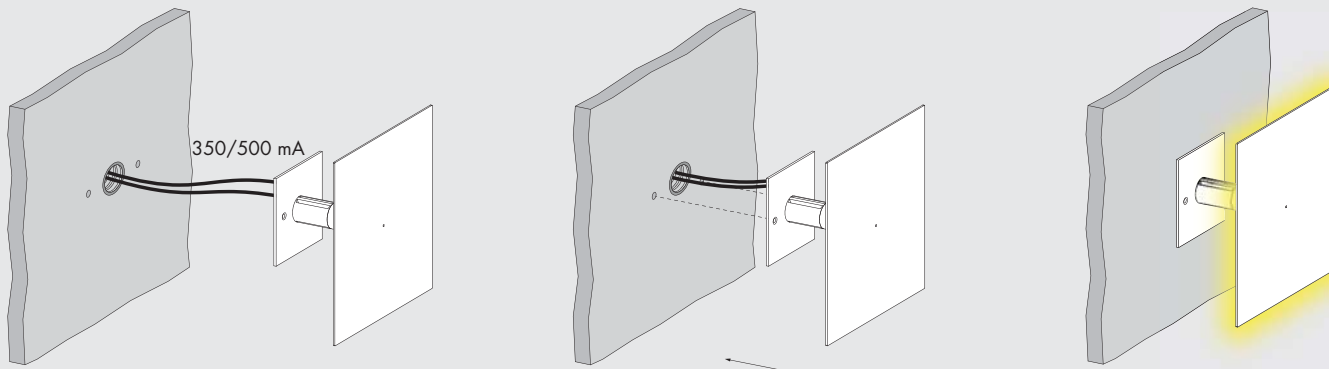

installazione con scatola incasso 3 moduli · installation with 3 modules recessed box

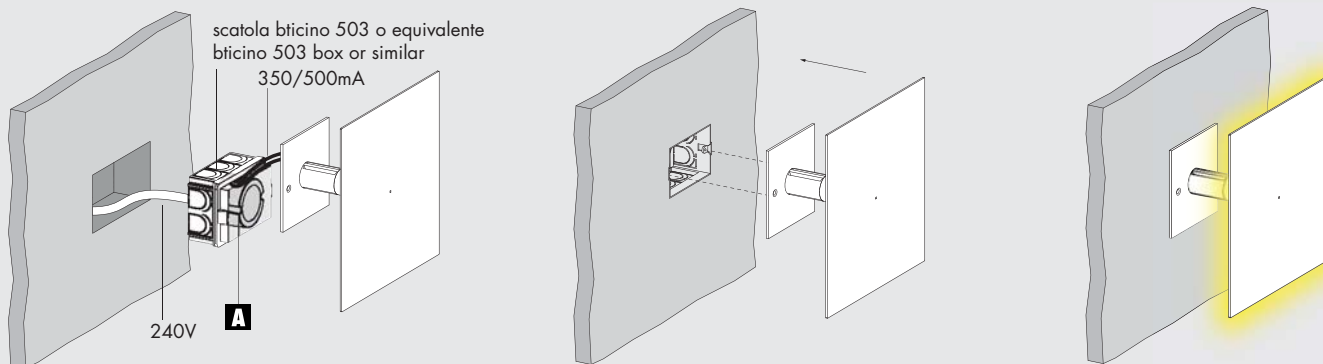

t4.382

installazione con scatola modello usa/canada · installation with usa/canada outlet box

