

Viabizzuno strada principale della frazione di bizzuno in provincia di ravenna dove tra la casa del popolo e la parrocchia, al n°17, sono nato il ventuno luglio millenovecentocinquantacinque. da qui nasce il nome della fabbrica di produzione fondata nel millenovecentonovantaquattro rappresentata da uno spazio bianco attraversato da due linee. una verticale, rigorosa, essenziale, equilibrata: la luce per la luce; ed una inclinata, irriverente nello spazio, ironica, fuori dagli schemi: la luce per la forma. distinte ma complementari si fondono in un unico nome: Viabizzuno.

Viabizzuno is the name of the main road of the small village bizzuno located in the province of ravenna, where I was born on the twenty-first july nineteenfiftyfive at n°17, between the 'casa del popolo' and the local parish church. from here the name of the factory founded in nineteen ninety-four represented by a white space intersected by two lines. one vertical, well balanced, logical, essential: the light for the light. the other one dynamic, irreverent, ironic: the light for the form. separate and yet complementary they cast in the same name: Viabizzuno. mario nanni

*i progetti rendono gli oggetti eterni,
le mode li corrompono, gli imbecilli li copiano
e li vendono agli ignoranti e ai deficienti.
noi progettiamo e lavoriamo per aiutare la luce
ad emozionarvi.*

*i frutti delle nostre idee e dei nostri progetti
sono protetti da brevetti
e/o modelli registrati
e/o da diritto d'autore.*

design makes objects timeless,
fashion corrupts them,
fools copy them and sell them to
ignorants and idiots.
we do projects and work to help light to bring
you true emotion.
the results of our ideas and our projects
are protected by patents
and/or registered models
and/or copyright.

al fine di offrire ai nostri clienti la massima qualità della luce utilizzando le più avanzate tecnologie, forti del nostro sapere artigiano costruito in italia, aggiorniamo costantemente i nostri apparecchi di illuminazione.

Viabizzuno si riserva il diritto di apportare ai propri modelli, senza nessun preavviso, qualsiasi modifica ritenesse opportuna. per dimensioni e codici fanno fede i nostri strumenti di lavoro www.Viabizzuno.com, [Viacommerce@](mailto:Viacommerce@viabizzuno.com), [Viabizzunoapplight](http://Viabizzunoapplight.com) e [Viabizzunoonline](http://Viabizzunoonline.com).

in order to provide to our customers the maximum quality of light using the most advanced technologies, being strong of our artisan knowledge made in italy, we constantly update our lighting fixtures.

Viabizzuno reserves the right to make any modification, considered worthwhile, to its own models, without any notification. for valid dimensions and codes please consult our working tools www.Viabizzuno.com, [Viacommerce@](mailto:Viacommerce@viabizzuno.com), [Viabizzunoapplight](http://Viabizzunoapplight.com) and [Viabizzunoonline](http://Viabizzunoonline.com).

lettura delle tabelle tecniche how to read technical tables

XXXXXXXXXXXXXXXXXX										
230V 50-60Hz				A	IP66					
a	b	c	d	e	f	g	g	h	i	

XXXXXXXXXXXXXXXXXX										
230V 50-60Hz				A	IP66					
Vbx.xxx.xx	nero55	3000K		35W	1,5					
l	m	n	o	i						

componenti. components.	IK10	CE	i
--------------------------------	-------------	----	---

accessori. accessories.	IK10	CE	i
--------------------------------	-------------	----	---

1	2	3	4	5	6	7	8	9	10	
Ra	R9	ies tm-30		sdcM	mA	V _{f(min)}	lm	W	lm/W	
98	98	Rf 96	Rg 103	step 1	350	27,6	1240	9,7	128	A++
xm000	les19	Ta25 °C		vita media · average life	500	27,9	1580	14,0	113	A+
70000 h	L80	B10								
11	12							13	14	

bandella tecnica. posizioni standard simbologie.
data plate. standard arrangement of symbols.

a	nome apparecchio di illuminazione · light fitting name
b	tensione di alimentazione · supply rating (Volt)
c	frequenza di alimentazione · supply frequency (Hertz)
d	alimentatore incluso o escluso · power supply included or not included
e	classe di isolamento · insulation class
f	grado di protezione · protection degree
g	marchio di certificazione · safety and quality standards certification
h	conforme alle direttive europee produced in compliance with EC directives
i	peso netto · net weight (kg)
l	codice · code
m	finitura · finish
n	temperatura colore sorgente elettronica colour temperature led source (Kelvin)
o	potenza della sorgente · source power (Watt)

componenti. identifica tutti gli elementi indispensabili per la corretta funzionalità e installazione dell'apparecchio di illuminazione.
components. includes all items that are essential to the correct operation and installation of the light fitting.

accessori. si riferisce alle ulteriori parti installabili sull'apparecchio.
accessories. refers to items that can be added to the light fitting.

1	indice di resa cromatica · colour rendering index
2	indice di resa del rosso · red colour rendering index
3	Rf indice di fedeltà colore · colour fidelity index Rg indice di saturazione colore · color gamut index
4	step di macadam · macadam step
5	corrente di alimentazione · power supply current
6	tensione di alimentazione · power supply voltage
7	flusso luminoso · light flux
8	potenza della sorgente · source power
9	efficienza della sorgente · source efficiency
10	classe di efficienza energetica · efficiency class
11	codice sorgente elettronica Viabizzuno · Viabizzuno led source code
12	superficie emittente · light emitting surface (mm)
13	% flusso residuo a fine vita · end life % flux
14	% consentita sotto limite · allowed % under limit

gradi di protezione protection degrees

IP0X	<i>non protetto</i> no protection	IPX0	<i>non protetto</i> no protection		
IP1X	<i>contro corpi estranei >50 mm</i> protection against solid objects	IPX1	<i>protetto contro la caduta verticale di gocce d'acqua</i> protected against water drops falling vertically	IK01	<i>nessuna protezione</i> no protection
IP2X	<i>contro corpi estranei >12 mm</i> protection against solid objects	IPX2	<i>protetto contro la caduta di gocce con inclinazione max 15°</i> protected against water drops max inclination 15°	IK01	<i>protetto contro l'energia d'urto 0,15J</i> protected against collision energy
IP3X	<i>contro corpi estranei >2,5 mm</i> protection against solid objects	IPX3	<i>protetto contro la caduta di gocce con inclinazione max 60°</i> protected against water drops max inclination 60°	IK02	<i>protetto contro l'energia d'urto 0,2J</i> protected against collision energy
IP4X	<i>contro corpi estranei >1 mm</i> protection against solid objects	IPX4	<i>protetto contro spruzzi d'acqua</i> protected against sprinkling water	IK03	<i>protetto contro l'energia d'urto 0,35J</i> protected against collision energy
IP5X	<i>protezione da polvere</i> dust-protected	IPX5	<i>protetto contro getti d'acqua</i> protected against water jets	IK04	<i>protetto contro l'energia d'urto 0,5J</i> protected against collision energy
IP6X	<i>stagno alla polvere</i> dust-proof	IPX6	<i>protetto contro inondazioni</i> protected against flooding	IK05	<i>protetto contro l'energia d'urto 0,7J</i> protected against collision energy
		IPX7	<i>per breve immersione</i> protected against brief immersions	IK06	<i>protetto contro l'energia d'urto 1J</i> protected against collision energy
		IPX8	<i>per immersione prolungata</i> protected against long immersion	IK07	<i>protetto contro l'energia d'urto 2J</i> protected against collision energy
				IK08	<i>protetto contro l'energia d'urto 5J</i> protected against collision energy
				IK09	<i>protetto contro l'energia d'urto 10J</i> protected against collision energy
				IK10	<i>protetto contro l'energia d'urto 20J</i> protected against collision energy

legenda simboli symbols key



tavolo · table



terra · floor standing



soffitto · ceiling



parete · wall



sospensione · suspension



binario · track



incasso · recessed



scomparsa totale · fully concealed



segnalatica+emergenza · signalling system+emergency



portatili autoalimentati a batteria · portable self-powered with battery



sistemi · systems



palo · pole



paletto · bollard



seduta · sitting



disponibile su · available on [Viabizzuno aplight](http://Viabizzuno.aplight) www.Viabizzuno.com [Viabizzuno online](http://Viabizzuno.online)



classe I. solo isolamento fondamentale, le parti conduttrici accessibili sono collegate ad un conduttore di terra. messa a terra tassativa
class I. only basic insulation, accessible conductors are earthed. earthing compulsory



classe II. all'isolamento principale è aggiunto un secondo isolamento oppure ai due isolamenti è sostituito un isolamento rinforzato. messa a terra esclusa
class II. basic insulation plus second insulation or both are replaced by reinforced insulation. earthing excluded



classe III. alimentazione effettuata con bassissima tensione di sicurezza; sono escluse tensioni superiori a 50V-50Hz. messa a terra non prevista.
class III. very low safety supply tension; not to be used over 50V-50Hz. earthing excluded.



prodotto conforme alle direttive europee · produced in compliance with ec directives



marchio di certificazione europea. certifica che il prodotto è conforme alle norme europee sulla sicurezza
component approved for north american market and suitable to be used and approved as part of a more complex system



componente certificato per il mercato nord americano idoneo ad essere utilizzato e valutato come parte di un sistema più complesso
component approved for north american market and suitable to be used and approved as part of a more complex system



apparecchio di illuminazione approvato da kema · kema approved light fitting



prodotto conforme agli standard presenti nel regno unito che regolamentano la sicurezza e la qualità dell'acqua · product complies with uk standards set out by water regulations



apparecchio di illuminazione certificato secondo le normative vigenti in polonia che regolamentano i dispositivi di sicurezza antincendio
certified light fitting according to the regulations about devices for fire safety in force in poland



prodotto idoneo per essere commercializzato nel mercato cinese · product suitable for the china market



prodotto finito idoneo per essere commercializzato nel mercato nord americano · listed product suitable for the north american market



apparecchio di illuminazione in corso di certificazione per essere commercializzato nel mercato nord americano
light fitting undergoing certification to be marketed in the north american market

IP20 grado di protezione · protection degree

 vetro opalino · opal glass

 vetro sabbiato · sanded glass

 vetro nero fumè · black smoke glass

 vetro trasparente · transparent glass

 vetro bianco latte · white milk glass

 cristallo · crystal

 policarbonato opalino · opal polycarbonate diffuser

 carrabile · drive over

 alimentatore incluso · power supply included

 alimentatore escluso · power supply not included

AR alimentatore remoto incluso · remote power supply included

Ai alimentatore elettronico con controllo intelligente incluso · electronic power supply with smart control included

AiR alimentatore elettronico con controllo intelligente incluso, da installare remoto · electronic power supply with smart control included, to be installed remotely

AS alimentatore a spina incluso · plug power supply included

T trasformatore incluso · transformer included

 trasformatore escluso · transformer not included

K kit di cablaggio · wiring kit

 kit di cablaggio escluso · wiring kit not included

L lampadina con sorgente elettronica led, ad incandescenza, alogena o fluorescente inclusa.
bulb with led electronic source, incandescent, halogen or fluorescent included.

 lampadina con sorgente elettronica led, ad incandescenza, alogena o fluorescente esclusa.
bulb with led electronic source, incandescent, halogen or fluorescent not included.

Pr propulsore dinamico n55 incluso · included

 possibilità di combinazione tra interfaccia n55, propulsore dinamico n55 e lampadina n55 · possible combination between n55 interface, propulsore dinamico n55 and n55 bulb

 attenzione: sorgente luminosa led. non guardare mai direttamente a occhio nudo · attention: led light source. never look straight without eye protection

ff flicker free compatibile con fotocamere digitali · flicker free digital camera friendly

l.d. luce diretta · direct light

l.i. luce indiretta · indirect light

.d1 dimmerazione 1-10V · 1-10V dimmable

.d2 dimmerazione dali · dimmable dali

.SA kit luce + emergenza sempre accese. attenzione: non è possibile installare nelle cassaforme laterizio
light kit + permanently lit emergency lamp. please note: cannot be installed in brickwork housing

.SE solo emergenza sempre accesa. attenzione: non è possibile installare nelle cassaforme laterizio
permanently lit emergency lamp only. please note: cannot be installed in brickwork housing

i peso netto · net weight (kg)

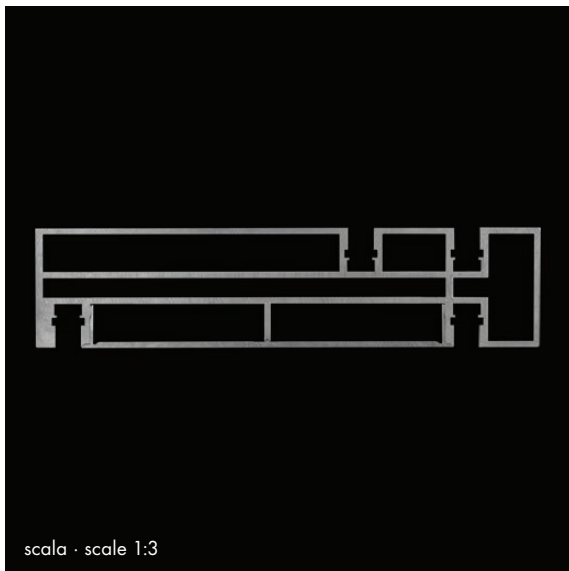

sistema per interni IP20 realizzato in alluminio estruso ossidato o sabbiato 200x48mm di lunghezza 2000mm o 3000mm.

sono presenti quattro gole di larghezza 10mm in cui sono alloggiati cavi di sezione 10,6x4,2mm con conduttori 2x1mm² alimentati a 24Vdc, con testate di alimentazione e terminali.

modelli: mensolona 01 con fissaggio laterale, mensolona 02 con fissaggio posteriore.

predisposto per le seguenti sorgenti elettroniche 2700K o 3000K 24Vdc: micromen 1W fino a 90lm 13° e 25°; 13x8 13W/m fino a 1510mm di lunghezza; n22 2,5W con diffusore in cristallo; trentotto 6W 544lm con ottiche 19° e 41°; eco mini 11,6W 1026lm 13° oppure 12,7W 1075lm con ottiche 17° e 31°; n55 con tige 350mm e n55 con tige 900mm 9,7W 1240lm configurabile con paralume in seta diametro Ø170mm h.135mm di colore blu o bianco; n55 sospensione e n55 orientabile 9,7W 1240lm configurabile con lampadina classica, decorativa e tecnica.

finiture: nero55 o alluminio naturale sabbiato trattato con olio di vaselina.

il prodotto è in alluminio naturale può presentare alterazioni dovuti alla naturale ossidazione a contatto con l'aria.

personalizza la tua luce vai su www.Viabizzuno.com

IP20 rated system for indoor use, made of oxidised or sanded extruded aluminium 200x48mm, length 2000mm or 3000mm.

four 10mm wide grooves in which is install 24Vdc cables having a 10.6x4.2mm section with 2x1mm² conductors, with end-feed and terminal heads.

versions: mensolona 01 with lateral fixing, mensolona 02 with rear fixing.

the following 2700K or 3000K 24Vdc led sources can be installed: micromen 1W up to 90lm 13° and 25°; 13x8 13W/m up to 1510mm in length; n22 2.5W with a crystal diffuser; trentotto 6W 454lm with 19° and 41° optics; eco mini 11.6W 1026lm 12° or 12.7W 1075lm with 17° and 31° optics; n55 with h. 350mm rod and n55 with h. 900mm rod 9.7W 1240lm which can be configured with a blue or white silk shade diameter Ø170mm h.135mm; n55 adjustable version 9.7W 1240lm which can be configured with standard, decorative and technical bulb.

finishes: nero55 or sanded natural aluminium, treated with paraffin oil. the product is made out of natural aluminum and any eventual alteration is due to the natural oxidation in contact with the air. customize your light visit www.Viabizzuno.com

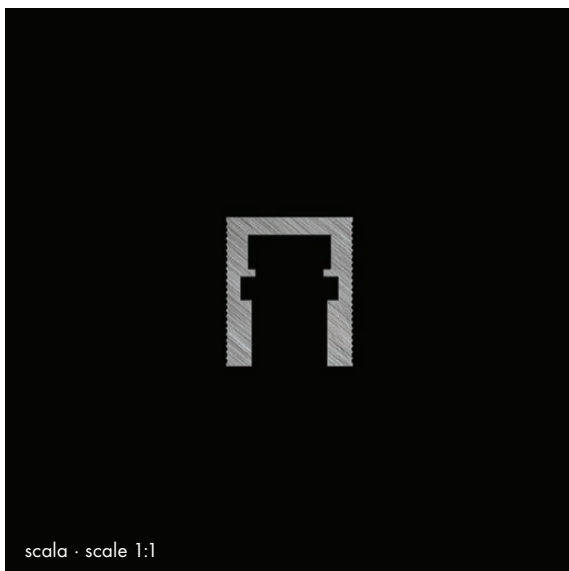

sistema per interni IP20 realizzato in alluminio estruso ossidato 17x20mm di lunghezza 2000mm o 3000mm.

gola di larghezza 10mm in cui è possibile alloggiare un cavo di sezione 10,6x4,2mm con conduttori 2x1mm² alimentato a 24Vdc.

predisposto per le seguenti sorgenti elettroniche 2700K o 3000K 24Vdc: micromen 1W fino a 90lm 13° e 25°; 13x8 13W/m fino a 1510mm; n22 2,5W con diffusore in cristallo; trentotto 5,6W 544lm con ottiche 19° e 41°; eco mini 11,6W 1026lm 13° oppure 12,7W 1075lm con ottiche 17° e 31°; n55 con tige 350mm e n55 con tige 900mm 9,7W 1240lm configurabile con paralume in seta diametro Ø170mm h.135mm di colore blu o bianco; n55 sospensione e n55 orientabile 9,7W 1240lm configurabile con lampadina classica, decorativa e tecnica.

finiture: nero55, argento hacca.

personalizza la tua luce vai su www.Viabizzuno.com

IP20 rated system for indoor use, made of oxidised extruded aluminium sizes 17x20mm length 2000mm or 3000mm.

10mm wide groove in which is possible to install of a 24Vdc cable having a 10.6x4.2mm section with 2x1mm² conductors.

the following 2700K or 3000K 24Vdc led sources can be installed: micromen 1W up to 90lm 13° and 25°; 13x8 13W/m up to 1510mm in length; n22 2.5W with a crystal diffuser; trentotto 5.6W 544lm with 19° and 41° optics; eco mini 11.6W 1026lm 13° or 12.7W 1075lm with 17° and 31° optics; n55 with h. 350mm rod and n55 with h. 900mm rod 9.7W 1240lm which can be configured with a blue or white silk shade diameter Ø170mm h.135mm; n55 adjustable version 9.7W 1240lm which can be configured with standard, decorative and technical bulb.

finishes: nero55, argento hacca.

customize your light visit www.Viabizzuno.com



mensolona

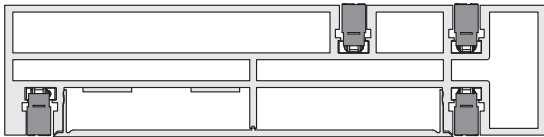

microtraccia



alimentazione
power source



microtraccia scomparsa totale



micromen



trentotto



ecomini



n55 orientabile 



n55 900 hm01



n55 sospensione 



n22



n55 350 hm01

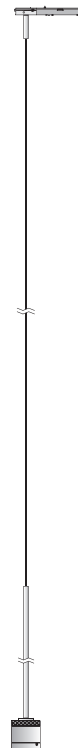

13x8



**lampadina classica
classic bulb**

**lampadina decorativa
decorative bulb**

**lampadina tecnica
technical bulb**

**accessori
accessories**

mn01 

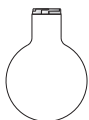

dc01 



dc04 



pz03 



mk01 

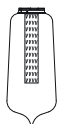

kk01 



ajp01 



spot35 



87°

spot55x37 



30° 38°

spot55x61 



36° 47°

spot82x35 



31° 42°

spot82x79 



23° 37° 46°

spot100 



16° 25° 40° 54°

lensoptica amP150 



22° 51°

lensoptica amP180 



15° 41° 53° 20°x55°

campane di vetro · glass bells



ripiani · shelves.



svuotatasche · catchalls



prese usb · usb ports



contenitori · containers

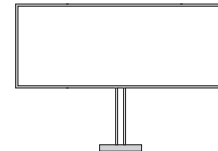
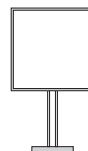

specchi · mirrors

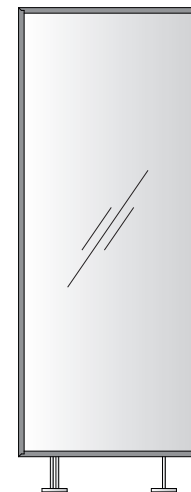





hm01 

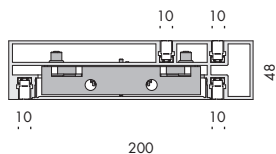
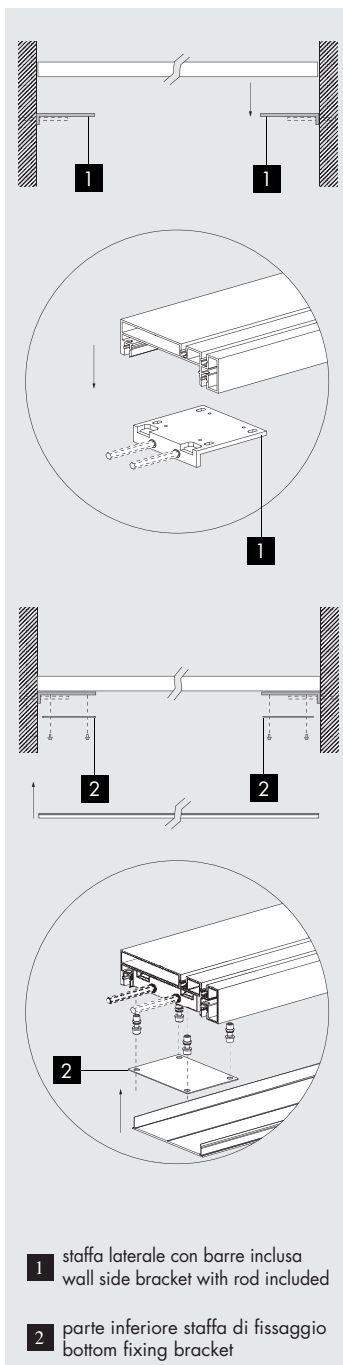

hm02 







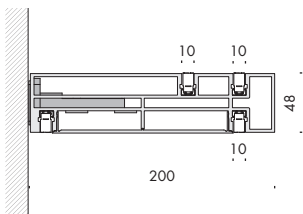

mensole 01 - fissaggio laterale max 4x4A 24Vdc   IP20    CE 

Vb5.619.01.1	alluminio naturale sabbiato sanded natural aluminium	2000mm	14
Vb5.619.02.1	nero55	2000mm	14
Vb5.619.05.1	alluminio naturale sabbiato sanded natural aluminium	3000mm	21
Vb5.619.06.1	nero55	3000mm	21





mensolona 02 - fissaggio posteriore max 4x4A 24Vdc    

Vb5.619.03.1	alluminio naturale sabbiato sanded natural aluminium	2000mm	14
Vb5.619.04.1	nero55	2000mm	14
Vb5.619.07.1	alluminio naturale sabbiato sanded natural aluminium	3000mm	21
Vb5.619.08.1	nero55	3000mm	21

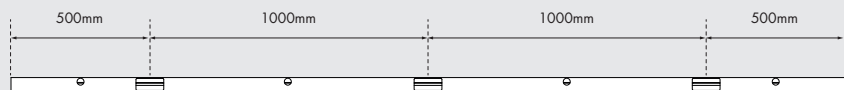

Vb5.619.07.1/08.1
con 3 staffe di fissaggio posteriori incluse
with 3 wall fixing side brackets included

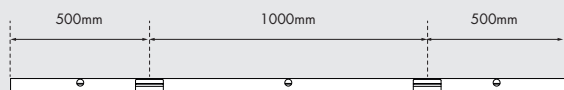

Vb5.619.03.1/04.1
con 2 staffe di fissaggio posteriori incluse
with 2 wall fixing side brackets included

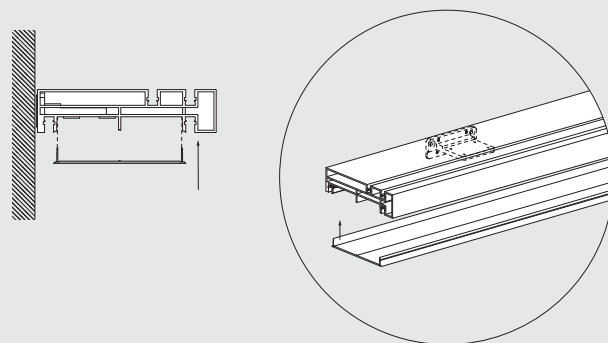
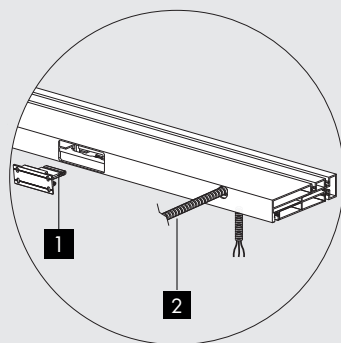
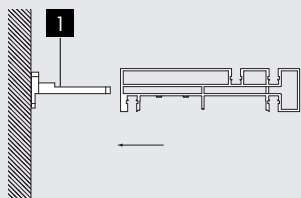
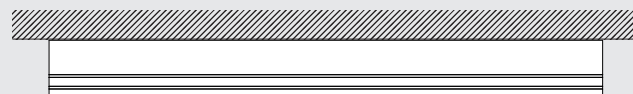
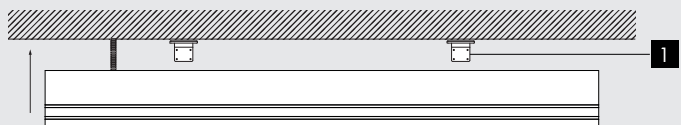

1 staffa di fissaggio posteriore inclusa
wall fixing rear bracket included

2 cavo di alimentazione
power supply cable



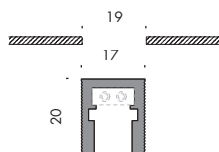

microtraccia ★ CE i

Vb6.619.14	argento hacca	2000mm	0,8
Vb6.619.18	nero55	2000mm	0,8
Vb6.619.15	argento hacca	3000mm	1,3
Vb6.619.16	nero55	3000mm	1,2

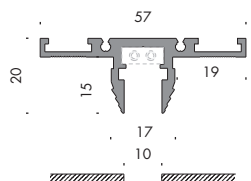

microtraccia scomparsa totale ★ CE i

Vb6.619.19	nero55	2000mm	0,8
Vb6.619.17	nero55	3000mm	1,2

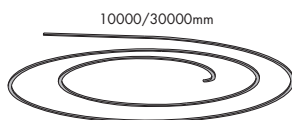

componenti. components. max 4A 24Vdc ★ CE i

Vb6.619.09	cavo nero 2 poli 2 poles black cable	2x1mm ² 10000mm	0,7
Vb6.619.11	cavo nero 2 poli 2 poles black cable	2x1mm ² 30000mm	2
Vb6.619.12	testata di alimentazione con cavo nero end-feed with black cable	2x0,75mm ² 3000mm	0,1



Vb6.619.13	testata terminale nera terminal black head		0,1
-------------------	---	--	-----

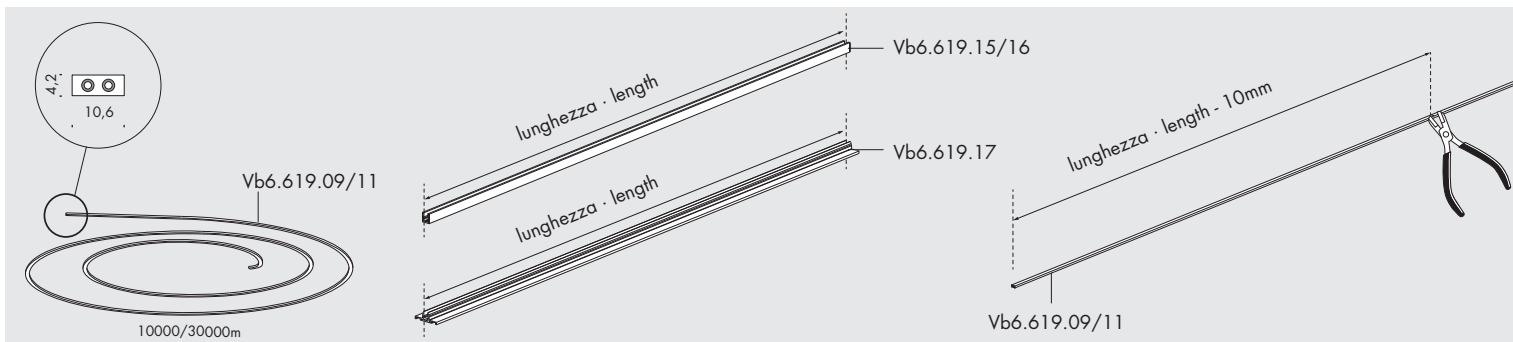

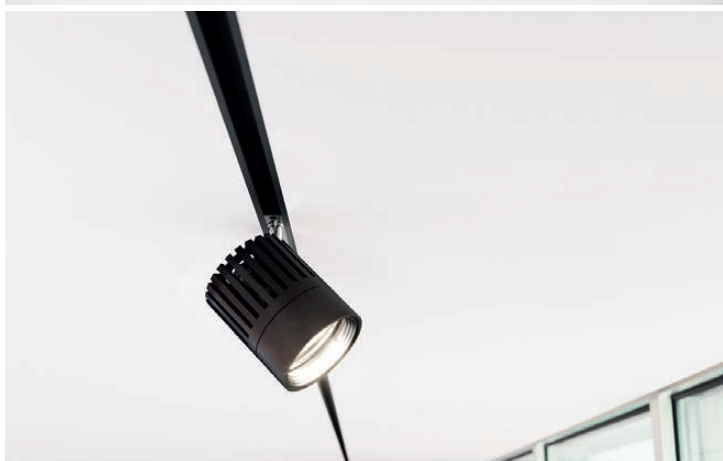

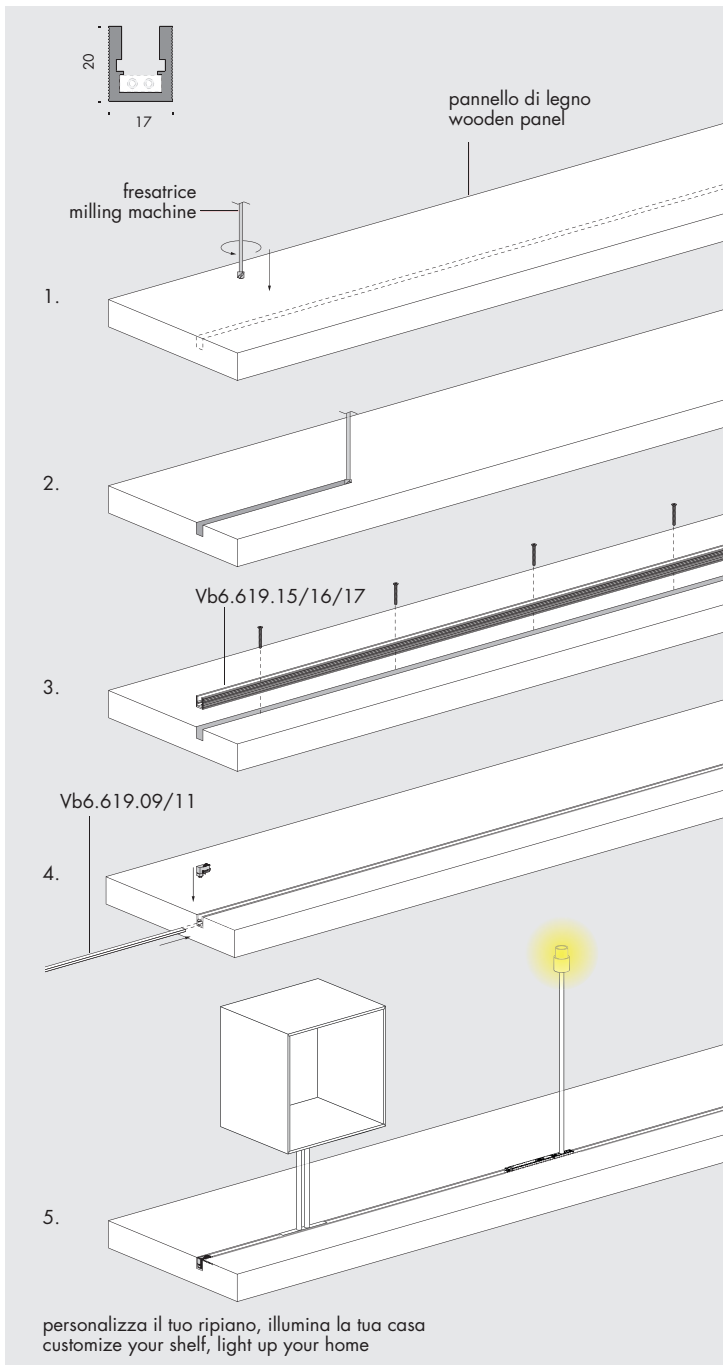



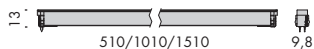
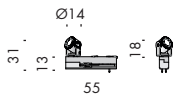

micromen	24Vdc					
-----------------	--------------	--	--	--	--	--

Vb6.619.20.27	alluminio lucido · polished aluminium	2700K	13°	0,1
Vb6.619.22.27	nero55	2700K	13°	0,1
Vb6.619.21.27	alluminio lucido · polished aluminium	2700K	25°	0,1
Vb6.619.23.27	nero55	2700K	25°	0,1

Ra	ies tm-30		sdc	mA	V _{f (min)}	lm	W	lm/W	
90	Rf 90	Rg 100	step 2	300	2,8	85	1	85	A++
ca010	les2	Ta25 °C		vita media · average life		50000 h	L80 B10		

Vb6.619.20.30	alluminio lucido · polished aluminium	3000K	13°	0,1
Vb6.619.22.30	nero55	3000K	13°	0,1
Vb6.619.21.30	alluminio lucido · polished aluminium	3000K	25°	0,1
Vb6.619.23.30	nero55	3000K	25°	0,1

Ra	ies tm-30		sdc	mA	V _{f (min)}	lm	W	lm/W	
90	Rf 90	Rg 100	step 2	300	2,8	90	1	90	A++
ca011	les2	Ta25 °C		vita media · average life		50000 h	L80 B10		

13x8	24Vdc					
-------------	--------------	--	--	--	--	--

Vb6.619.25.27	argento opaco · matt silver	2700K	7,5W	510mm	0,2
Vb6.619.26.27	argento opaco · matt silver	2700K	13W	1010mm	0,4
Vb6.619.27.27	argento opaco · matt silver	2700K	19,5W	1510mm	0,6

Ra	R9	ies tm/30		sdc	Vf	lm/m	W/m	lm/W	
95	90	Rf 90	Rg 98	step 2	24	1200	13	92	A+
V0000	5,9	Ta25 °C		vita media · average life		50000 h	L80 B10		

Vb6.619.25.30	argento opaco · matt silver	3000K	7,5W	510mm	0,2
Vb6.619.26.30	argento opaco · matt silver	3000K	13W	1010mm	0,4
Vb6.619.27.30	argento opaco · matt silver	3000K	19,5W	1510mm	0,6

Ra	R9	ies tm/30		sdc	Vf	lm/m	W/m	lm/W	
95	90	Rf 93	Rg 102	step 2	24	1250	13	96	A+
V0001	5,9	Ta25 °C		vita media · average life		50000 h	L80 B10		

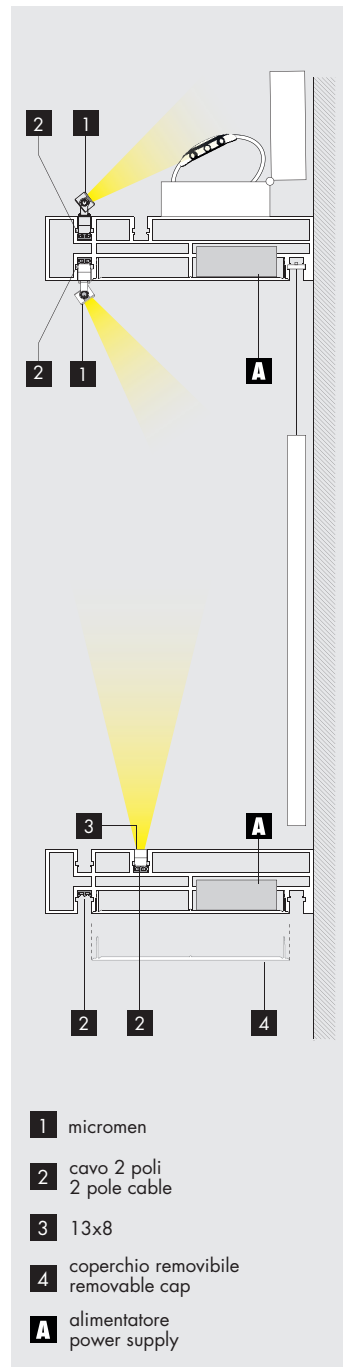

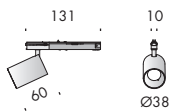
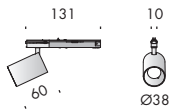
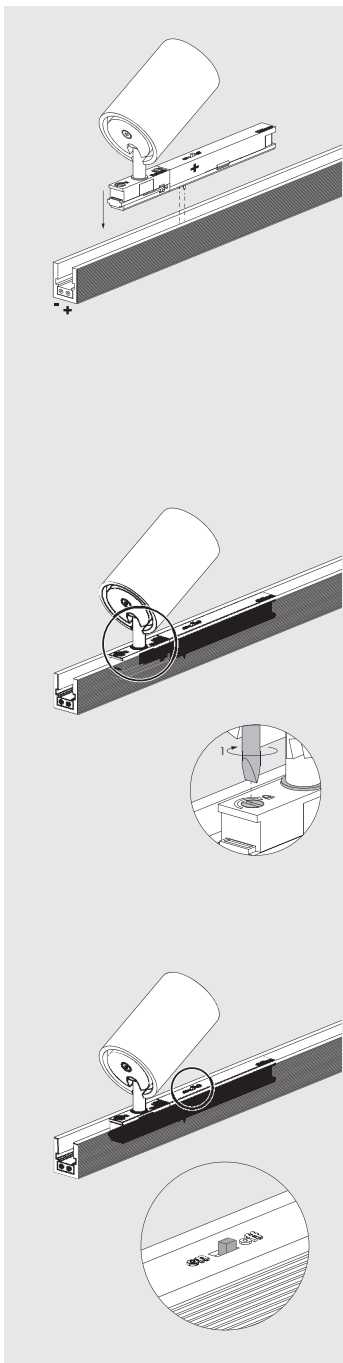

trentotto 19°	24Vdc								
----------------------	--------------	--	--	--	--	--	--	--	--

Vb6.619.35.27	nero55	2700K	19°	0,2
Vb6.619.36.27	argento hacca	2700K	19°	0,2
Vb6.619.37.27	my bianco	2700K	19°	0,2

Ra	R9	ies tm-30		sdc	mA	V _{f (min)}	lm	W	lm/W	
95	95	Rf 95	Rg 100	step 2	350	16,0	544	5,6	97	A+
cd040	les6	Ta25 °C		vita media · average life		50000 h	L70	B10		

Vb6.619.35.30	nero55	3000K	19°	0,2
Vb6.619.36.30	argento hacca	3000K	19°	0,2
Vb6.619.37.30	my bianco	3000K	19°	0,2

Ra	ies tm-30		sdc	mA	V _{f (min)}	lm	W	lm/W	
95	Rf 92	Rg 100	step 2	350	17	455	6	76	A+
cd011	les6	Ta25 °C		vita media · average life		50000 h	L70	B10	

trentotto 41°	24Vdc								
----------------------	--------------	--	--	--	--	--	--	--	--

Vb6.619.39.27	nero55	2700K	41°	0,2
Vb6.619.40.27	argento hacca	2700K	41°	0,2
Vb6.619.41.27	my bianco	2700K	41°	0,2

Ra	R9	ies tm-30		sdc	mA	V _{f (min)}	lm	W	lm/W	
95	95	Rf 92	Rg 100	step 2	350	16,0	544	5,6	97	A+
cd040	les6	Ta25 °C		vita media · average life		50000 h	L70	B10		

Vb6.619.39.30	nero55	3000K	41°	0,2
Vb6.619.40.30	argento hacca	3000K	41°	0,2
Vb6.619.41.30	my bianco	3000K	41°	0,2

Ra	ies tm-30		sdc	mA	V _{f (min)}	lm	W	lm/W	
95	Rf 92	Rg 100	step 2	350	17	455	6	76	A+
cd011	les6	Ta25 °C		vita media · average life		50000 h	L70	B10	

mobilizzazione
della cultura
per i lavoratori in lotta
500 milioni per
la innocenti leyland
e le altre fabbriche
concerto del pianista bruno canino
conservatorio di musica milano
1° marzo 1976 ore 21

programma:
ludwig van beethoven sonata op 14 n. 1
franz schubert alla klavier
franz listz concerto in re
frank richard wagner opera burgomestre
george gershwin his preludes
pianoforte
bruno canino



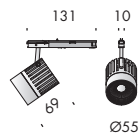
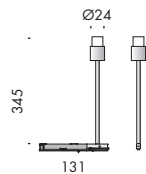

n22		24Vdc		IP20		CE			
Vb6.619.30	nero55	2700K		luce diffusa diffused light		0,2			
Vb6.619.31	argento hacca	2700K		luce diffusa diffused light		0,2			

Ra	R9	ies tm-30		sdc	mA	V _{f (min)}	lm	W	lm/W	
95	90	Rf 93	Rg 102	step 2	700	3,1	240	2,5	96	A++
Vy010	les16	Ta25 °C		vita media · average life		50000 h		L80 B10		

eco mini 13°		24Vdc		IP20		CE			
Vb6.619.45.27	nero55	2700K		13°		0,4			
Vb6.619.46.27	argento hacca	2700K		13°		0,4			
Vb6.619.47.27	my bianco	2700K		13°		0,4			

Ra	R9	ies tm-30		sdc	mA	V _{f (min)}	lm	W	lm/W	
95	95	Rf 95	Rg 100	step 2	700	16,5	1026	11,6	89	A+
cd040	les6	Ta25 °C		vita media · average life		50000 h		L70 B10		

Vb6.619.45.30	nero55	3000K		13°		0,4			
Vb6.619.46.30	argento hacca	3000K		13°		0,4			
Vb6.619.47.30	my bianco	3000K		13°		0,4			

Ra	ies tm-30		sdc	mA	V _{f (min)}	lm	W	lm/W	
95	Rf 92	Rg 100	step 2	700	17,8	826	12,4	66	A
cd011	les6		Ta25 °C		vita media · average life		50000 h		L70 B10

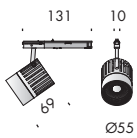

eco mini 17°		24Vdc						
---------------------	--	--------------	--	--	--	--	--	--

Vb6.619.49.27	nero55	2700K	17°	0,4
Vb6.619.50.27	argento hacca	2700K	17°	0,4
Vb6.619.51.27	my bianco	2700K	17°	0,4

Ra	ies tm-30		sdc	mA	V _{f (min)}	lm	W	lm/W	
95	Rf 92	Rg 100	step 2	700	18,2	1000	12,7	79	A
ce000	les9 ●	Ta25 °C		vita media · average life		50000 h	L70 B10		

Vb6.619.49.30	nero55	3000K	17°	0,4
Vb6.619.50.30	argento hacca	3000K	17°	0,4
Vb6.619.51.30	my bianco	3000K	17°	0,4

Ra	ies tm-30		sdc	mA	V _{f (min)}	lm	W	lm/W	
95	Rf 92	Rg 100	step 2	700	18,2	1075	12,7	85	A+
ce001	les9 ●	Ta25 °C		vita media · average life		50000 h	L70 B10		

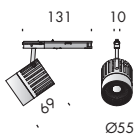

eco mini 31°		24Vdc						
---------------------	--	--------------	--	--	--	--	--	--

Vb6.619.53.27	nero55	2700K	31°	0,4
Vb6.619.54.27	argento hacca	2700K	31°	0,4
Vb6.619.55.27	my bianco	2700K	31°	0,4

Ra	ies tm-30		sdc	mA	V _{f (min)}	lm	W	lm/W	
95	Rf 92	Rg 100	step 2	700	18,2	1000	12,7	79	A
ce000	les9 ●	Ta25 °C		vita media · average life		50000 h	L70 B10		

Vb6.619.53.30	nero55	3000K	31°	0,4
Vb6.619.54.30	argento hacca	3000K	31°	0,4
Vb6.619.55.30	my bianco	3000K	31°	0,4

Ra	ies tm-30		sdc	mA	V _{f (min)}	lm	W	lm/W	
95	Rf 92	Rg 100	step 2	700	18,2	1075	12,7	85	A+
ce001	les9 ●	Ta25 °C		vita media · average life		50000 h	L70 B10		

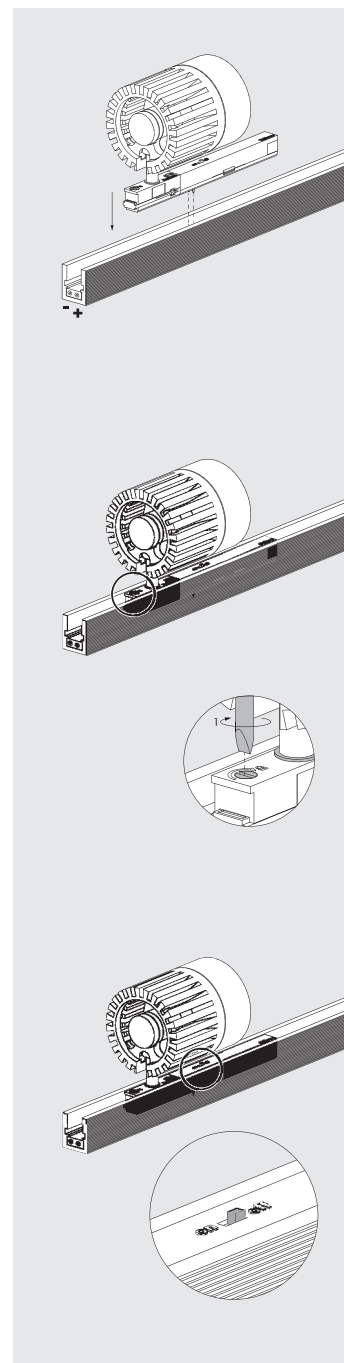

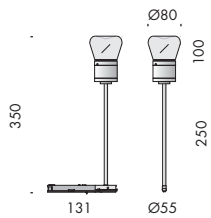

n55 350 hm01		24Vdc					IP20			CE	
Vb6.619.57.27	nero55	bianco latte · milk white		2700K	0,3						
Vb6.619.58.27	argento hacca	bianco latte · milk white		2700K	0,3						
Vb6.619.59.27	my bianco	bianco latte · milk white		2700K	0,3						
Ra	R9	ies tm-30		sdc	mA	V _{f(min)}	lm	W	lm/W		
98	98	Rf 96	Rg 103	step 1	350	27,6	1240	9,7	128	A++	
xm000	les19	Ta25 °C		vita media · average life		70000 h	L80	B10			

Vb6.619.57.30	nero55	bianco latte · milk white		3000K	0,3						
Vb6.619.58.30	argento hacca	bianco latte · milk white		3000K	0,3						
Vb6.619.59.30	my bianco	bianco latte · milk white		3000K	0,3						

Ra	R9	ies tm-30		sdc	mA	V _{f(min)}	lm	W	lm/W	
98	98	Rf 96	Rg 103	step 1	350	27,6	1240	9,7	128	A++
xm001	les19	Ta25 °C		vita media · average life		70000 h	L80	B10		

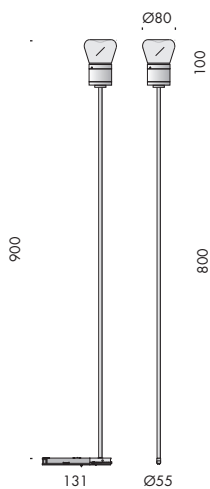

n55 900 hm01		24Vdc					IP20			CE	
Vb6.619.60.27	nero55	bianco latte · milk white		2700K	0,3						
Vb6.619.61.27	argento hacca	bianco latte · milk white		2700K	0,3						
Vb6.619.62.27	my bianco	bianco latte · milk white		2700K	0,3						
Ra	R9	ies tm-30		sdc	mA	V _{f(min)}	lm	W	lm/W		
98	98	Rf 96	Rg 103	step 1	350	27,6	1240	9,7	128	A++	
xm000	les19	Ta25 °C		vita media · average life		70000 h	L80	B10			

Vb6.619.60.30	nero55	bianco latte · milk white		3000K	0,3						
Vb6.619.61.30	argento hacca	bianco latte · milk white		3000K	0,3						
Vb6.619.62.30	my bianco	bianco latte · milk white		3000K	0,3						

Ra	R9	ies tm-30		sdc	mA	V _{f(min)}	lm	W	lm/W	
98	98	Rf 96	Rg 103	step 1	350	27,6	1240	9,7	128	A++
xm001	les19	Ta25 °C		vita media · average life		70000 h	L80	B10		

paralumi. lampshades.

☆ CE i



Ø170



Vb6.619.64

seta blu attacco inferiore
blue silk bottom attachment

0,2

Vb6.619.65

seta bianco attacco inferiore
white silk bottom attachment

0,2



Ø170



Vb6.590.82

seta blu attacco superiore
blue silk upper attachment

0,2

Vb6.590.81

seta bianco attacco superiore
white silk upper attachment

0,2

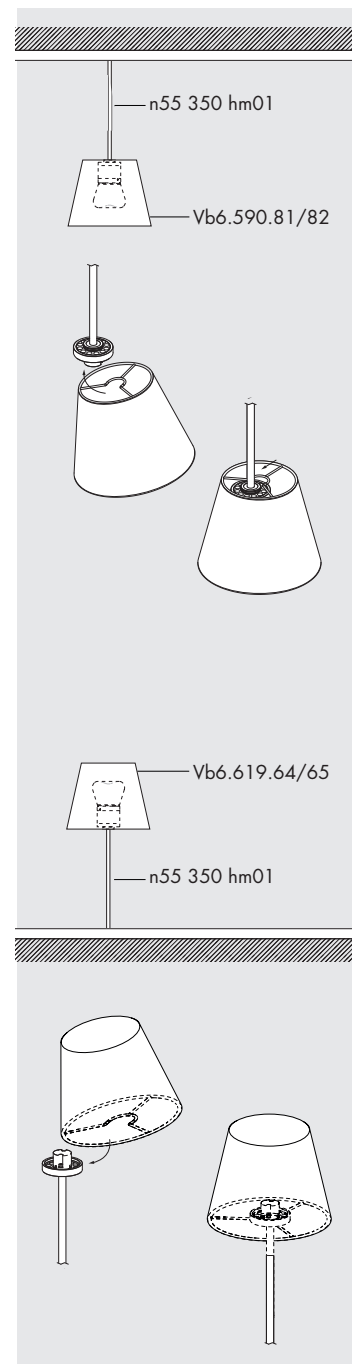

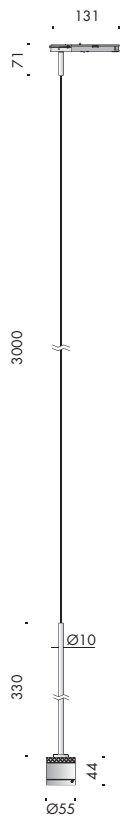

n55 sospensione	24Vdc				IP20			CE	
------------------------	--------------	--	--	--	-------------	--	--	-----------	--

Vb6.619.150.27	nero55	adattatore nero black adapter	2700K	0,4
Vb6.619.151.27	argento hacca	adattatore nero black adapter	2700K	0,4
Vb6.619.152.27	my bianco	adattatore nero black adapter	2700K	0,4

Ra	R9	ies tm-30		sdc	mA	V _{f (min)}	lm	W	lm/W	
98	98	Rf 96	Rg 103	step 1	350	27,6	1240	9,7	128	A++
xm000	les19	Ta25 °C		vita media · average life			70000 h	L80	B10	

Vb6.619.150.30	nero55	adattatore nero black adapter	3000K	0,4
Vb6.619.151.30	argento hacca	adattatore nero black adapter	3000K	0,4
Vb6.619.152.30	my bianco	adattatore nero black adapter	3000K	0,4

Ra	R9	ies tm-30		sdc	mA	V _{f (min)}	lm	W	lm/W	
98	98	Rf 96	Rg 103	step 1	350	27,6	1240	9,7	128	A++
xm001	les19	Ta25 °C		vita media · average life			70000 h	L80	B10	

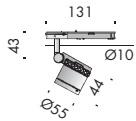

n55 orientabile		24Vdc	▲	PR	◆	IP20	▲	☆	CE	!
Vb6.619.156.27	nero55	adattatore nero black adapter	2700K	0,3						
Vb6.619.157.27	argento hacca	adattatore nero black adapter	2700K	0,3						
Vb6.619.158.27	my bianco	adattatore nero black adapter	2700K	0,3						

Ra	R9	ies tm-30		sdc	mA	V _{f (min)}	lm	W	lm/W	▲
98	98	Rf 96	Rg 103	step 1	350	27,6	1240	9,7	128	A++
xm000	les19	●	Ta25 °C	vita media · average life			70000 h	L80	B10	

Vb6.619.156.30	nero55	adattatore nero black adapter	3000K	0,3						
Vb6.619.157.30	argento hacca	adattatore nero black adapter	3000K	0,3						
Vb6.619.158.30	my bianco	adattatore nero black adapter	3000K	0,3						

Ra	R9	ies tm-30		sdc	mA	V _{f (min)}	lm	W	lm/W	▲
98	98	Rf 96	Rg 103	step 1	350	27,6	1240	9,7	128	A++
xm001	les19	●	Ta25 °C	vita media · average life			70000 h	L80	B10	





mario nanni

☆ CE i

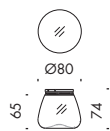

Vb9.580.01.t

hm01 trasparente · transparent

0,05

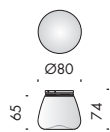

Vb9.580.01.s

hm01 sabbziata · sanded

0,05

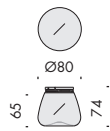

Vb9.580.01.b

hm01 bianco latte · milk white

0,05

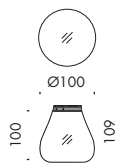

Vb9.580.02.t

hm02 trasparente · transparent

0,1

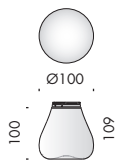

Vb9.580.02.s

hm02 sabbziata · sanded

0,1

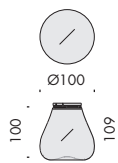

Vb9.580.02.b

hm02 bianco latte · milk white

0,1

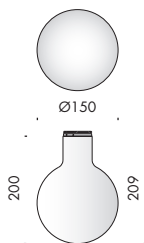

mario nanni



Vb9.580.03.s mn01 sabbiaata · sanded

0,3

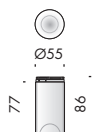

david chipperfield



Vb9.580.05.s dc01 sabbiaata · sanded

0,1

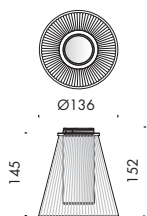

Vb9.580.20.tr dc04 trasparente, rigato · transparent, striped

0,3

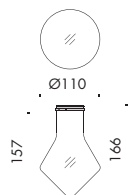

peter zumthor



Vb9.580.11.t pz03 trasparente · transparent

0,2

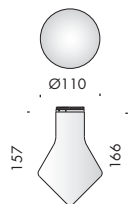

Vb9.580.11.s pz03 sabbiaata · sanded

0,2



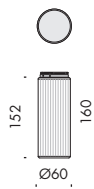
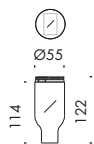
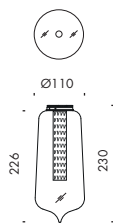

marcio kogan



Vb9.580.111.t mk01 trasparente · transparent

0,4

kengo kuma



Vb9.580.07.c kk01 cristallo · crystal

0,3

al-jawad pike



Vb9.580.18.tr ajp01 trasparente, rigato · transparent, striped

0,2

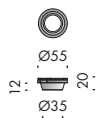

spot35		★	CE	i
Vb9.580.21	argento hacca	87° les 19	●	0,1
Vb9.580.22	nero55	87° les 19	●	0,1
Vb9.580.22.b	my bianco	87° les 19	●	0,1

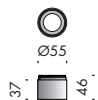

spot55x37		★	CE	i
Vb9.580.123	argento hacca	30° les 19	●	0,1
Vb9.580.124	nero55	30° les 19	●	0,1
Vb9.580.124.b	my bianco	30° les 19	●	0,1
Vb9.580.125	argento hacca	38° les 19	●	0,1
Vb9.580.126	nero55	38° les 19	●	0,1
Vb9.580.126.b	my bianco	38° les 19	●	0,1

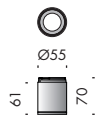

spot55x61		★	CE	i
Vb9.580.25	argento hacca	36° les 19	●	0,2
Vb9.580.26	nero55	36° les 19	●	0,2
Vb9.580.26.b	my bianco	36° les 19	●	0,2
Vb9.580.27	argento hacca	47° les 19	●	0,2
Vb9.580.28	nero55	47° les 19	●	0,2
Vb9.580.28.b	my bianco	47° les 19	●	0,2



accessori. accessories.		★	CE	i
Vb9.580.91	frangiluce nido d'ape · honeycomb louvre			0,01



Vb9.580.92	lente ellittica · elliptical lens			0,04
-------------------	-----------------------------------	--	--	------



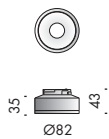

spot82x35		★	CE	ⓘ
Vb9.580.135	argento hacca	31° les19	●	0,1
Vb9.580.136	nero55	31° les19	●	0,1
Vb9.580.141	my bianco	31° les19	●	0,1
Vb9.580.139	argento hacca	42° les19	●	0,1
Vb9.580.140	nero55	42° les19	●	0,1
Vb9.580.142	my bianco	42° les19	●	0,1

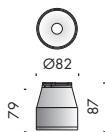

spot82x79		★	CE	ⓘ
Vb9.580.31	argento hacca	23° les19	●	0,2
Vb9.580.32	nero55	23° les19	●	0,2
Vb9.580.32.b	my bianco	23° les19	●	0,2
Vb9.580.33	argento hacca	37° les19	●	0,2
Vb9.580.34	nero55	37° les19	●	0,2
Vb9.580.34.b	my bianco	37° les19	●	0,2
Vb9.580.35	argento hacca	46° les19	●	0,2
Vb9.580.36	nero55	46° les19	●	0,2
Vb9.580.36.b	my bianco	46° les19	●	0,2

accessori spot82. accessories.



 Ø75, 4	Vb9.580.86 frangiluce nido d'ape · honeycomb louvre	0,01
 Ø75, 4	Vb9.580.87 lente ellittica · elliptical lens	0,05
 Ø75, 4	Vb9.580.88 vetro albarino · albarino glass	0,05
 16 : Ø74,5	Vb9.580.165 anti abbagliamento · anti-glare	0,03

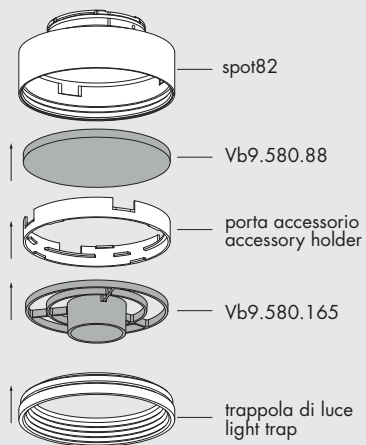
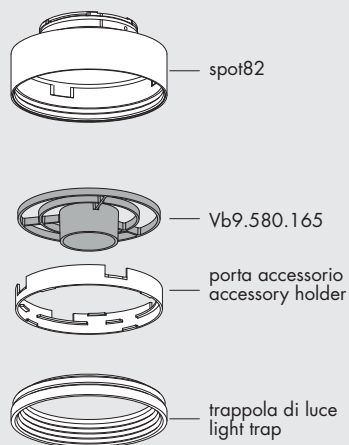

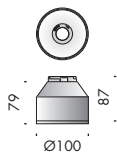

spot100		★	CE	ⓘ
Vb9.580.37	argento hacca	16° les19	●	0,1
Vb9.580.38	nero55	16° les19	●	0,1
Vb9.580.38.b	my bianco	16° les19	●	0,1
Vb9.580.39	argento hacca	25° les19	●	0,1
Vb9.580.40	nero55	25° les19	●	0,1
Vb9.580.40.b	my bianco	25° les19	●	0,1
Vb9.580.41	argento hacca	40° les19	●	0,1
Vb9.580.42	nero55	40° les19	●	0,1
Vb9.580.42.b	my bianco	40° les19	●	0,1
Vb9.580.43	argento hacca	54° les19	●	0,1
Vb9.580.44	nero55	54° les19	●	0,1
Vb9.580.44.b	my bianco	54° les19	●	0,1

accessori spot100. accessories.		★	CE	ⓘ
Vb9.580.93	frangiluce nido d'ape · honeycomb louvre			0,01
Vb9.580.94	lente ellittica · elliptical lens			0,05



lensoptica amP è il risultato di una ricerca sviluppata da Viabizzuno su progetto david chipperfield architects con lo studio internazionale di ingegneria arup per fornire alle sorgenti luminose elettroniche un'ottica ad alta efficienza in grado di avere sia una luce concentrata che diffusa. L'alta efficienza viene ottenuta utilizzando un materiale ad altissima trasparenza, il polimetilmetacrilato, per mezzo di prismi catadiottrici progettati per riflettere e trasmettere la luce minimizzando le perdite per assorbimento: tali elementi riflettono verso il basso il 90% del flusso luminoso incidente e ne trasmettono il 10% garantendo così una percentuale di emissione indiretta, non ottenibile con il riflettore in metallo.

la matrice di microlenti regola in modo preciso l'ampiezza angolare del fascio luminoso.

l'ampia superficie emittente garantisce un alto comfort visivo e UGR<19.

lensoptica amP is the result of a long research and development process made by Viabizzuno on a david chipperfield architects with arup, international engineering studio, design to provide electronic light sources with a high efficiency optics that can have either a focused and a diffuse light.

high efficiency is achieved thanks to a very high transparent material, i.e. polymethyl methacrylate, by means of catadioptric prisms specifically designed to reflect and transmit light reducing losses due to absorption: these elements, reflect 90% of the incident light flow downwards and transmit 10% of it, assuring this way a percentage of indirect emission which could not be reached with metal reflector.

the microlens array precisely regulates the angular amplitude of the light beam.

the large emitter surface limits luminance, ensuring high visual comfort and UGR<19.

propulsore dinamico n55

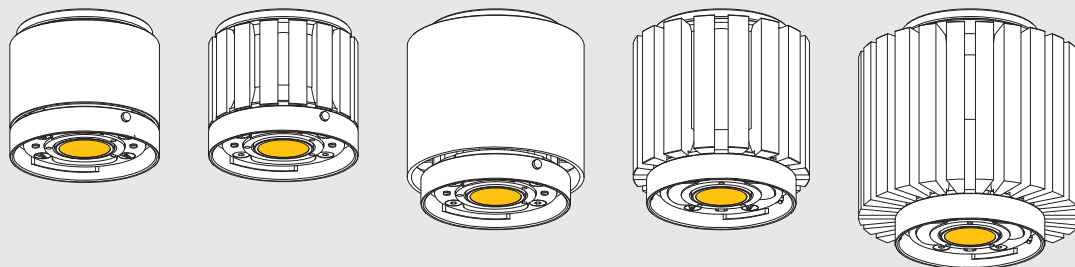

riflettore in metallo · metal reflector

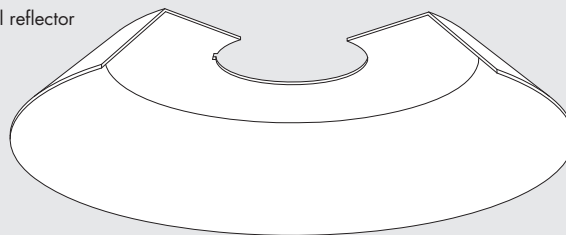

lensoptica amP

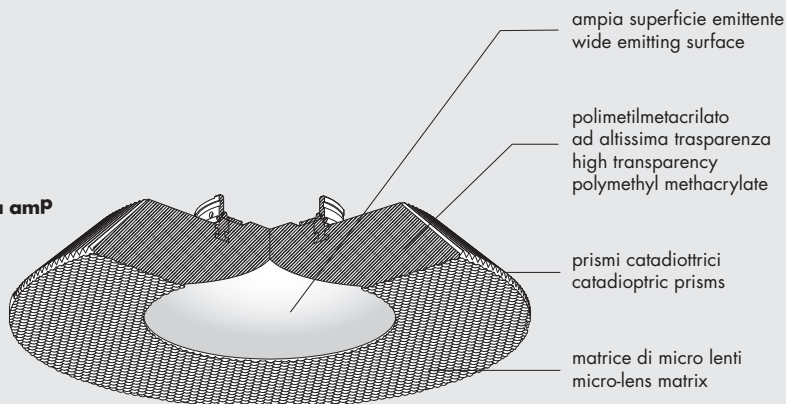

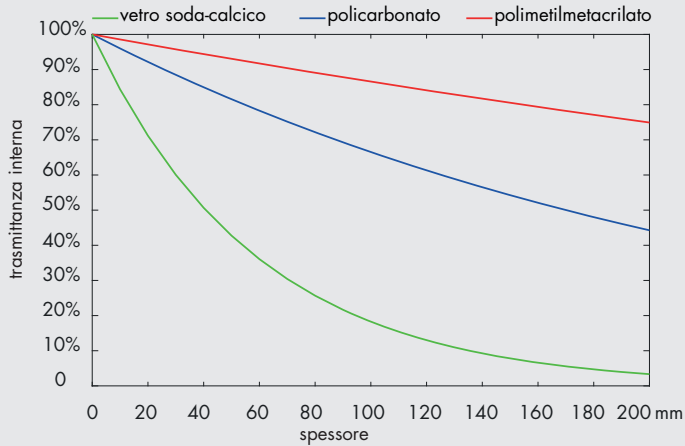

la trasmittanza interna (T) di un materiale trasparente è determinata dallo spessore (x) e dal coefficiente d'assorbimento del materiale stesso (α) secondo la legge di Lambert-Beer $T_{(x)} = e^{-\alpha x}$
 the internal transmittance of a transparent material (T) is determined by the thickness (x) and by the absorbing coefficient of the material itself (α) due to Lambert-Beer law $T_{(x)} = e^{-\alpha x}$

materiale	coefficiente d'assorbimento α
vetro soda calcico	0,017 mm ⁻¹
policarbonato	0,004 mm ⁻¹
polimetilmetacrilato	0,0014 mm ⁻¹

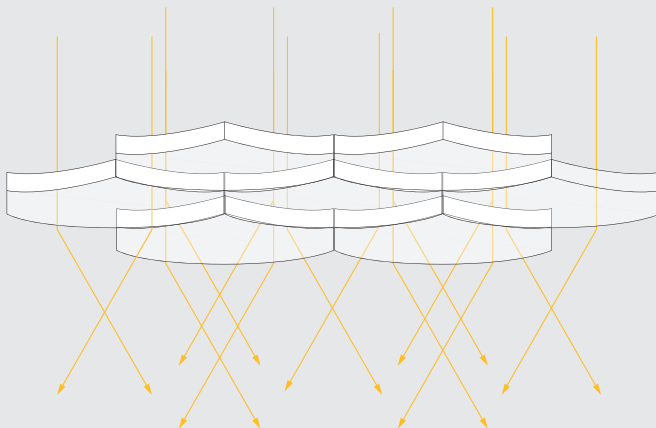
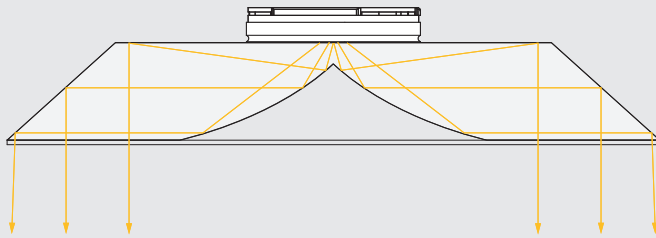

lensoptica amP è allo stesso tempo una lente e un riflettore, perché i raggi di luce subiscono rifrazione e riflessione totale interna. per questa caratteristica tecnica riesce a coniugare alta efficienza e accurato controllo direzionale della luce.
lensoptica amP is both a lens and a reflector at the same time, because the rays of light undergo refraction and total internal reflection. for this technical characteristic it combines high efficiency and accurate directional control of light.

la superficie emittente di **lensoptica amP** è dotata di una matrice di microlenti. ogni microlente riceve un fascio collimato e in funzione della curvatura ne allarga l'apertura angolare in modo controllato. la sovrapposizione dei contributi delle singole microlenti produce una distribuzione d'illuminamento uniforme.

le **lensoptica amP** si suddividono in quattro categorie di apertura angolare del fascio: stretto, medio, largo ed ellittico. il valore esatto dell'angolo dipende dal diametro della sorgente.

lensoptica amP emitter surface is equipped with a microlens array. each microlens receives a collimated beam and according to its curvature it enlarges the angular opening in a controlled way. the overlap of the emissions of each microlens creates a uniform distribution of illumination.

lensoptica amP are divided into four categories based on the angular opening of the beam: narrow, medium, wide and elliptical. the exact value of the angle depends on the source diameter.

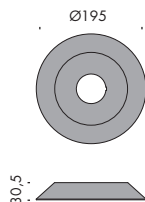
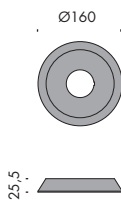
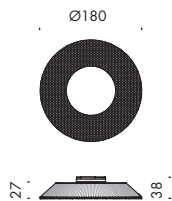
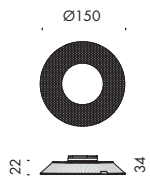

lensoptica amP150		☆	CE	i
-------------------	--	---	----	---

Vb9.518.91	fascio stretto · narrow beam	22°	les19	0,3
Vb9.518.92	fascio largo · wide beam	51°	les19	0,3

lensoptica amP180		☆	CE	i
-------------------	--	---	----	---

Vb9.518.81	fascio stretto · narrow beam	15°	les19	0,6
Vb9.518.82	fascio medio · medium beam	41°	les19	0,6
Vb9.518.83	fascio largo · wide beam	53°	les19	0,6
Vb9.518.84	fascio ellittico · elliptical beam	20°x55°	les19	0,6

riflettore in metallo 150		☆	CE	i
---------------------------	--	---	----	---

Vb9.518.95.n	nero55			0,1
Vb9.518.95.mb	my bianco			0,1
Vb9.518.95.h	argento hacca			0,1

riflettore in metallo 180		☆	CE	i
---------------------------	--	---	----	---

Vb9.518.96.n	nero55			0,1
Vb9.518.96.mb	my bianco			0,1
Vb9.518.96.h	argento hacca			0,1



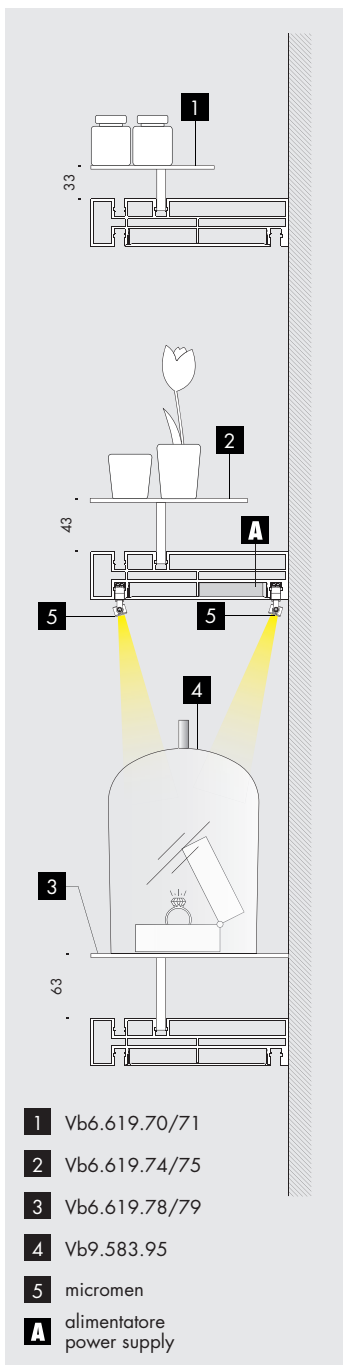

1 Vb6.619.70/71

2 Vb6.619.74/75

3 Vb6.619.78/79

4 Vb9.583.95

5 micromen

A alimentatore
power supply

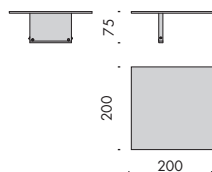
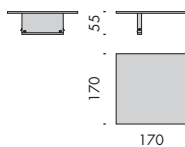
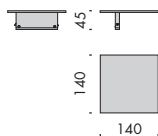

ripiani. shelves.

★ CE ⓘ

Vb6.619.70 ottone naturale · natural brass 1

Vb6.619.71 nero55 1

Vb6.619.74 ottone naturale · natural brass 1,4

Vb6.619.75 nero55 1,4

Vb6.619.78 ottone naturale · natural brass 1,8

Vb6.619.79 nero55 1,8

campane di vetro. glass bells.

★ CE ⓘ

Vb6.619.67 vetro trasparente · transparent glass 0,9

Vb9.583.95 vetro trasparente · transparent glass 0,7



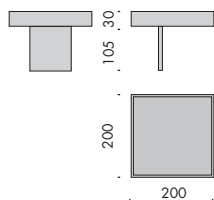
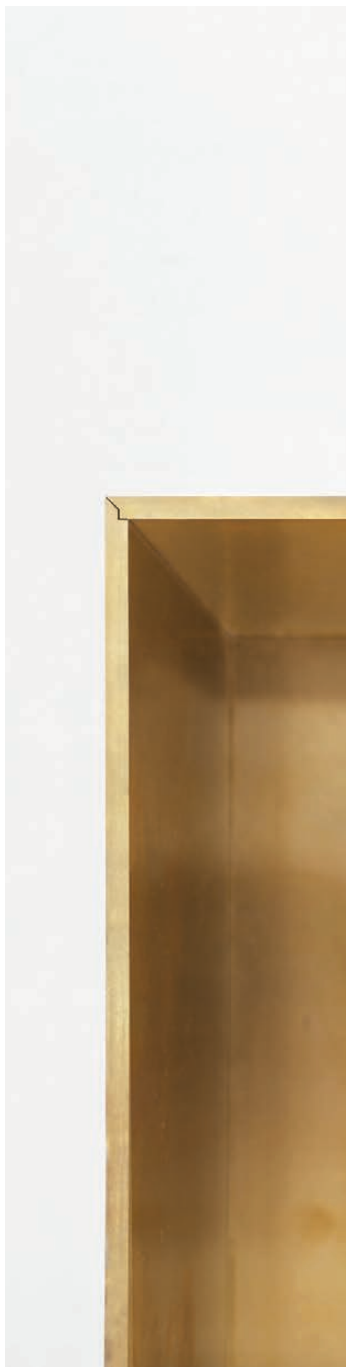

svuotatasche. catchalls.



Vb6.619.93	ottone naturale · natural brass	2
Vb6.619.94	nero55	1,2

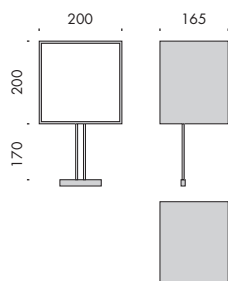

contenitori. containers.



Vb6.619.97	ottone naturale · natural brass	3
Vb6.619.98	nero55	1,5

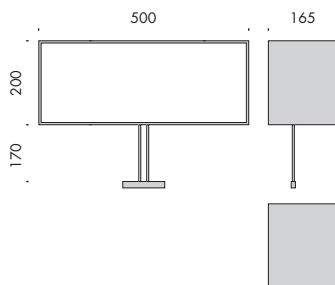

Vb6.619.101	ottone naturale · natural brass	7
Vb6.619.102	nero55	3,7

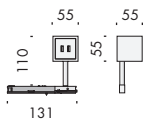

prese usb. usb ports. **24Vdc**

Vb6.619.165	nero55	0,2
Vb6.619.167	argento hacca	0,2

1 mensolona

2 specchio h.640mm
mirror

3 prese usb
usb ports

4 ripiano plus
shelf plus

5 n55 350 con paralume
with lampshade

6 campana di vetro h.400mm
glass bells

7 ripiano 140x140mm
shelf

8 ripiano 170x170mm
shelf

9 ripiano 210x210
shelf

10 clip

11 13x8

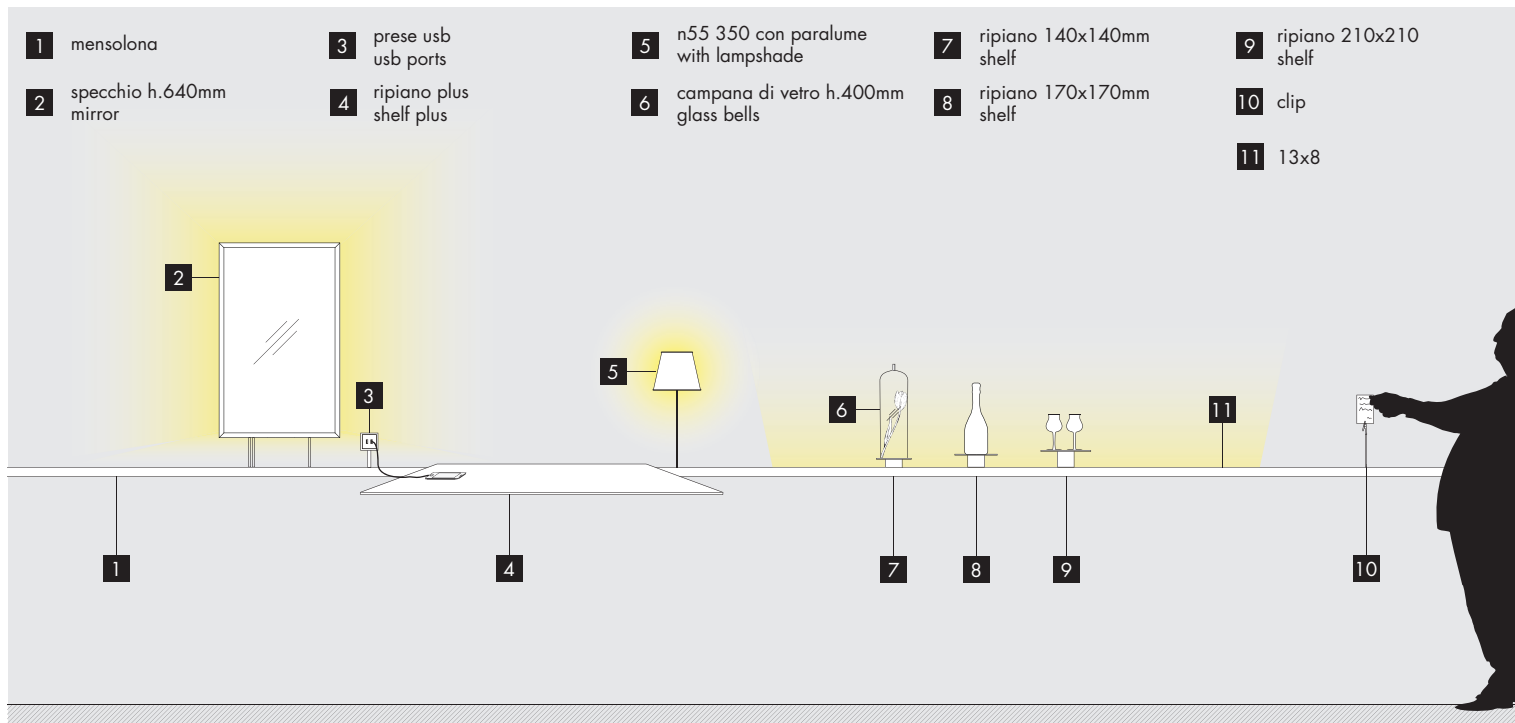





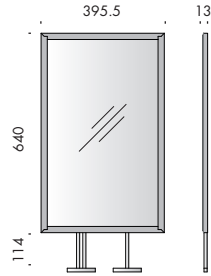

specchi. mirrors.		24Vdc		☑	⊕	★	CE	i	
Vb6.619.105.27	nero55	2700K	26W						3,2
Vb6.619.106.27	argento hacca	2700K	26W						3,2

Ra	R9	ies tm/30		sdc	Vf	lm/m	W/m	lm/W	☑
95	90	Rf 90	Rg 98	step 2	24	1200	13	92	A+
V0000	5,9	Ta25 °C		vita media · average life		50000 h	L80	B10	

Vb6.619.105.30	nero55	3000K	26W						3,2
Vb6.619.106.30	argento hacca	3000K	26W						3,2

Ra	R9	ies tm/30		sdc	Vf	lm/m	W/m	lm/W	☑
95	90	Rf 93	Rg 102	step 2	24	1250	13	96	A+
V0001	5,9	Ta25 °C		vita media · average life		50000 h	L80	B10	

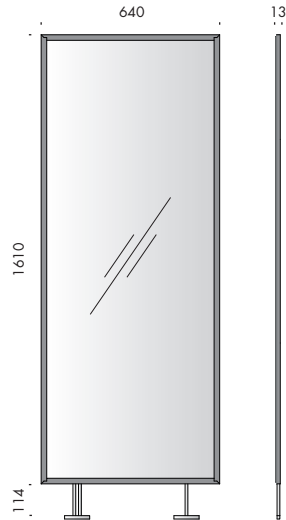

Vb6.619.108.27	nero55	2700K	58W						13
Vb6.619.109.27	argento hacca	2700K	58W						13

Ra	R9	ies tm/30		sdc	Vf	lm/m	W/m	lm/W	☑
95	90	Rf 90	Rg 98	step 2	24	1200	13	92	A+
V0000	5,9	Ta25 °C		vita media · average life		50000 h	L80	B10	

Vb6.619.108.30	nero55	3000K	58W						13
Vb6.619.109.30	argento hacca	3000K	58W						13

Ra	R9	ies tm/30		sdc	Vf	lm/m	W/m	lm/W	☑
95	90	Rf 93	Rg 102	step 2	24	1250	13	96	A+
V0001	5,9	Ta25 °C		vita media · average life		50000 h	L80	B10	

1 mensolona

5 n55 350 con paralume
with lampshade

7 ripiano 140x140mm
shelf

8 ripiano 170x170mm
shelf

11 13x8

12 porta asciugamani
towel rail

13 specchio h. 1610mm
mirror

14 lavandino · sink

15 contenitore 200x200mm
container

16 campana di vetro h.210mm
glass bell

17 svuotatasche · catchall

18 porta carta igienica
toilet paper holder

19 contenitore 200x500mm
container

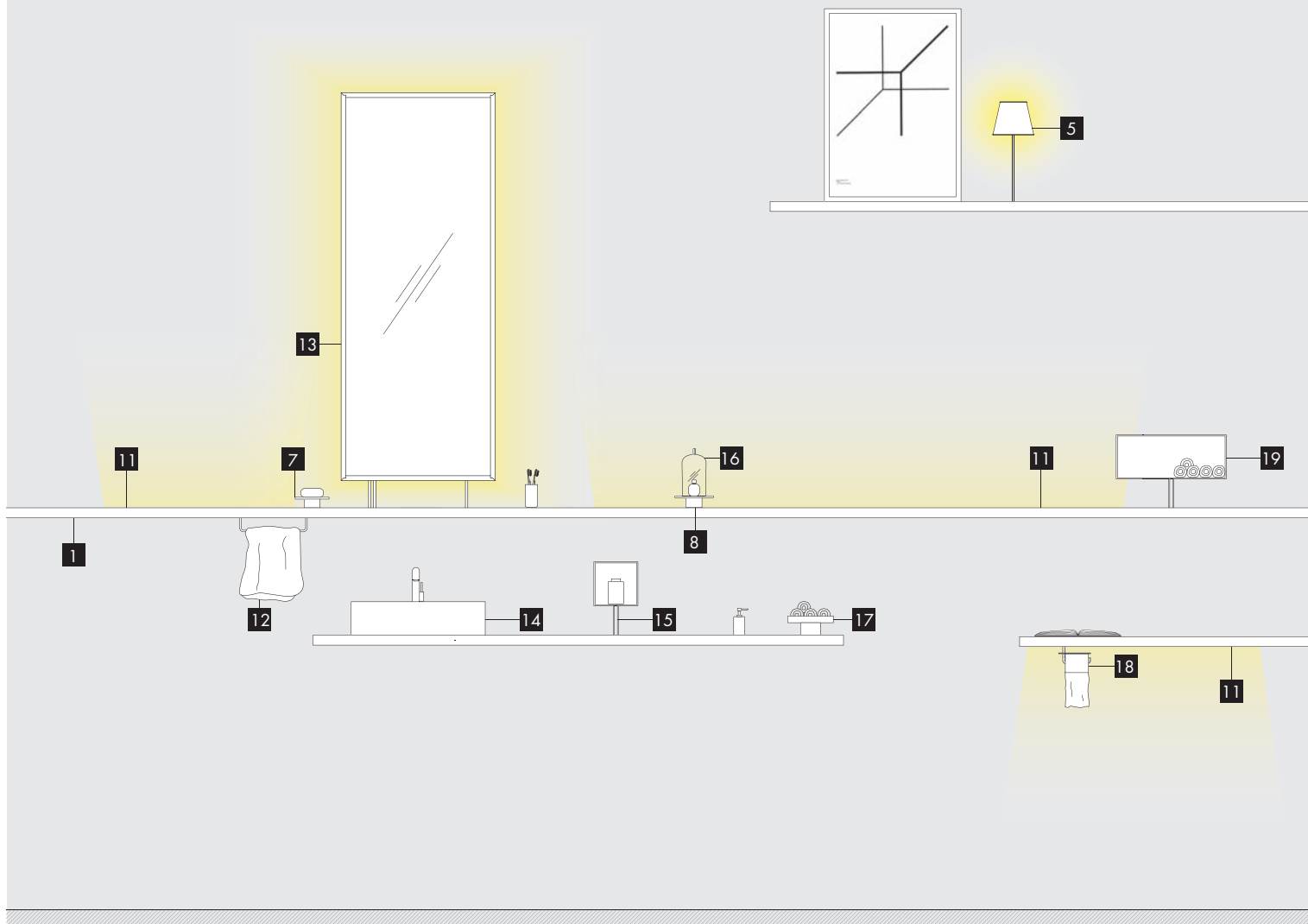

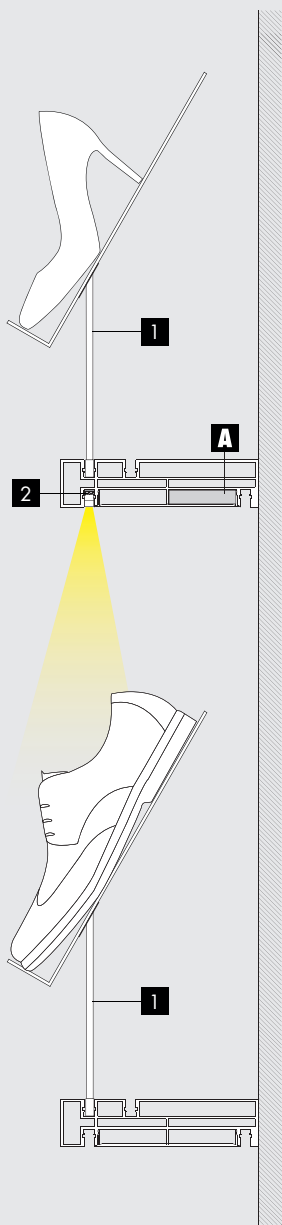

- 1 leggio
bookstand
- 2 13x8
- alimentatore
power supply





personalizza la tua luce
vai su Viabizzuno.com

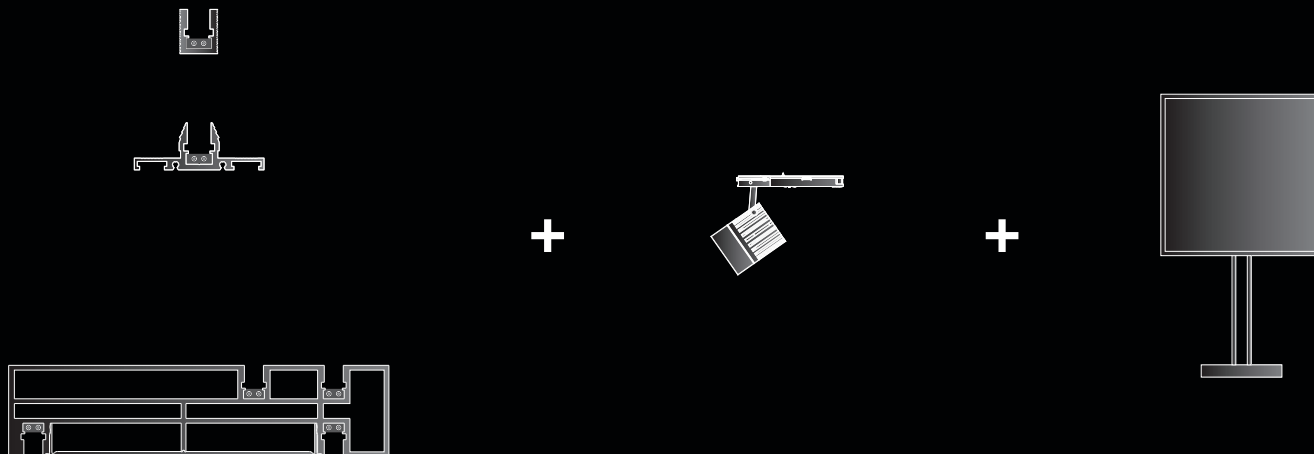

1. scegli il profilo
choose the profile

2. scegli la sorgente luminosa
choose the light source

3. scegli gli accessori
choose the accessories