

*Viabizzuno strada principale della frazione di bizzuno in provincia di ravenna dove tra la casa del popolo e la parrocchia, al n°17, sono nato il ventuno luglio millenovecentocinquantacinque. da qui nasce il nome della fabbrica di produzione fondata nel millenovecentonovantaquattro rappresentata da uno spazio bianco attraversato da due linee. una verticale, rigorosa, essenziale, equilibrata: la luce per la luce; ed una inclinata, irriverente nello spazio, ironica, fuori dagli schemi: la luce per la forma. distinte ma complementari si fondono in un unico nome: Viabizzuno.*

Viabizzuno is the name of the main road of the small village bizzuno located in the province of ravenna, where I was born on the twenty-first july nineteenfiftyfive at n°17, between the 'casa del popolo' and the local parish church. from here the name of the factory founded in nineteen ninety-four represented by a white space intersected by two lines. one vertical, well balanced, logical, essential: the light for the light. the other one dynamic, irreverent, ironic: the light for the form. separate and yet complementary they cast in the same name: Viabizzuno. marionanni

*i progetti rendono gli oggetti eterni,  
le mode li corrompono, gli imbecilli li copiano  
e li vendono agli ignoranti e ai deficienti.  
noi progettiamo e lavoriamo per aiutare la luce  
ad emozionarvi.*

*i frutti delle nostre idee e dei nostri progetti  
sono protetti da brevetti  
e/o modelli registrati  
e/o da diritto d'autore.*

design makes objects timeless,  
fashion corrupts them,  
fools copy them and sell them to  
ignorants and idiots.  
we do projects and work to help light to bring  
you true emotion.  
the results of our ideas and our projects  
are protected by patents  
and/or registered models  
and/or copyright.

*al fine di offrire ai nostri clienti la massima qualità della luce utilizzando le più avanzate tecnologie, forti del nostro sapere artigiano costruito in italia, aggiorniamo costantemente i nostri apparecchi di illuminazione.*

*Viabizzuno si riserva il diritto di apportare ai propri modelli, senza nessun preavviso, qualsiasi modifica ritenesse opportuna. per dimensioni e codici fanno fede i nostri strumenti di lavoro [www.Viabizzuno.com](http://www.Viabizzuno.com), [Viacommerce@](mailto:Viacommerce@viabizzuno.com), [Viabizzunoapplight](http://Viabizzunoapplight.com) e [Viabizzunoonline](http://Viabizzunoonline.com).*

*in order to provide to our customers the maximum quality of light using the most advanced technologies, being strong of our artisan knowledge made in italy, we constantly update our lighting fixtures.*

*Viabizzuno reserves the right to make any modification, considered worthwhile, to its own models, without any notification. for valid dimensions and codes please consult our working tools [www.Viabizzuno.com](http://www.Viabizzuno.com), [Viacommerce@](mailto:Viacommerce@viabizzuno.com), [Viabizzunoapplight](http://Viabizzunoapplight.com) and [Viabizzunoonline](http://Viabizzunoonline.com).*

# lettura delle tabelle tecniche how to read technical tables

XXXXXXXXXXXXXXXXXX										
230V 50-60Hz				A	⊕	IP66		US	CE	
a	b	c	d	e	f	g	g	h	i	

XXXXXXXXXXXXXXXXXX										
230V 50-60Hz				A	⊕	IP66		US	CE	
Vbx.xxx.xx	nero55	3000K		35W	1,5					
l	m	n	o	i						

<b>componenti. components.</b>	IK10	CE	
--------------------------------	------	----	--

<b>accessori. accessories.</b>	IK10	CE	
--------------------------------	------	----	--

1	2	3	4	5	6	7	8	9	10
---	---	---	---	---	---	---	---	---	----

Ra	R9	ies tm/30		sdcM	Vf	lm/m	W/m	lm/W	
95	90	Rf 90	Rg 98	step 2	24	1200	13	92	F
V0000	5,9		Ta25 °C	vita media · average life	50000 h	L80	B10		

11	12	13	14
----	----	----	----

bandella tecnica. posizioni standard simbologie.  
data plate. standard arrangement of symbols.

a	nome apparecchio di illuminazione · light fitting name
b	tensione di alimentazione · supply rating (Volt)
c	frequenza di alimentazione · supply frequency (Hertz)
d	alimentatore incluso o escluso · power supply included or not included
e	classe di isolamento · insulation class
f	grado di protezione · protection degree
g	marchio di certificazione · safety and quality standards certification
h	conforme alle direttive europee produced in compliance with EC directives
i	peso netto · net weight (kg)
l	codice · code
m	finitura · finish
n	temperatura colore sorgente elettronica colour temperature led source (Kelvin)
o	potenza della sorgente · source power (Watt)

componenti. identifica tutti gli elementi indispensabili per la corretta funzionalità e installazione dell'apparecchio di illuminazione.  
components. includes all items that are essential to the correct operation and installation of the light fitting.

accessori. si riferisce alle ulteriori parti installabili sull'apparecchio.  
accessories. refers to items that can be added to the light fitting.















1	indice di resa cromatica · colour rendering index
2	indice di resa del rosso · red colour rendering index
3	Rf indice di fedeltà colore · colour fidelity index Rg indice di saturazione colore · color gamut index
4	step di macadam · macadam step
5	corrente di alimentazione · power supply current
6	tensione di alimentazione · power supply voltage
7	flusso luminoso · light flux
8	potenza della sorgente · source power
9	efficienza della sorgente · source efficiency
10	classe di efficienza energetica · efficiency class
11	codice sorgente elettronica Viabizzuno · Viabizzuno led source code
12	superficie emittente · light emitting surface (mm)
13	% flusso residuo a fine vita · end life % flux
14	% consentita sotto limite · allowed % under limit



## gradi di protezione protection degrees

IP0X	<i>non protetto</i> no protection	IPX0	<i>non protetto</i> no protection	IK01	<i>nessuna protezione</i> no protection
IP1X	<i>contro corpi estranei &gt;50 mm</i> protection against solid objects	IPX1	<i>protetto contro la caduta verticale di gocce d'acqua</i> protected against water drops falling vertically	IK01	<i>protetto contro l'energia d'urto 0,15J</i> protected against collision energy
IP2X	<i>contro corpi estranei &gt;12 mm</i> protection against solid objects	IPX2	<i>protetto contro la caduta di gocce con inclinazione max 15°</i> protected against water drops max inclination 15°	IK02	<i>protetto contro l'energia d'urto 0,2J</i> protected against collision energy
IP3X	<i>contro corpi estranei &gt;2,5 mm</i> protection against solid objects	IPX3	<i>protetto contro la caduta di gocce con inclinazione max 60°</i> protected against water drops max inclination 60°	IK03	<i>protetto contro l'energia d'urto 0,35J</i> protected against collision energy
IP4X	<i>contro corpi estranei &gt;1 mm</i> protection against solid objects	IPX4	<i>protetto contro spruzzi d'acqua</i> protected against sprinkling water	IK04	<i>protetto contro l'energia d'urto 0,5J</i> protected against collision energy
IP5X	<i>protezione da polvere</i> dust-protected	IPX5	<i>protetto contro getti d'acqua</i> protected against water jets	IK05	<i>protetto contro l'energia d'urto 0,7J</i> protected against collision energy
IP6X	<i>stagno alla polvere</i> dust-proof	IPX6	<i>protetto contro inondazioni</i> protected against flooding	IK06	<i>protetto contro l'energia d'urto 1J</i> protected against collision energy
		IPX7	<i>per breve immersione</i> protected against brief immersions	IK07	<i>protetto contro l'energia d'urto 2J</i> protected against collision energy
		IPX8	<i>per immersione prolungata</i> protected against long immersion	IK08	<i>protetto contro l'energia d'urto 5J</i> protected against collision energy
				IK09	<i>protetto contro l'energia d'urto 10J</i> protected against collision energy
				IK10	<i>protetto contro l'energia d'urto 20J</i> protected against collision energy

## legenda simboli symbols key

-  tavolo · table
-  terra · floor standing
-  soffitto · ceiling
-  parete · wall
-  sospensione · suspension
-  binario · track
-  incasso · recessed
-  scomparsa totale · fully concealed
-  segnaletica+emergenza · signalling system+emergency
-  portatili autoalimentati a batteria · portable self-powered with battery
-  sistemi · systems
-  palo · pole
-  paletto · bollard
-  seduta · sitting

 disponibile su · available on [Viabizzuno aplight](http://Viabizzuno.aplight) [www.Viabizzuno.com](http://www.Viabizzuno.com) [Viabizzuno online](http://Viabizzuno.online)

 classe I. solo isolamento fondamentale, le parti conduttrici accessibili sono collegate ad un conduttore di terra. messa a terra tassativa  
class I. only basic insulation, accessible conductors are earthed. earthing compulsory

 classe II. all'isolamento principale è aggiunto un secondo isolamento oppure ai due isolamenti è sostituito un isolamento rinforzato. messa a terra esclusa  
class II. basic insulation plus second insulation or both are replaced by reinforced insulation. earthing excluded

 classe III. alimentazione effettuata con bassissima tensione di sicurezza; sono escluse tensioni superiori a 50V-50Hz. messa a terra non prevista.  
class III. very low safety supply tension; not to be used over 50V-50Hz. earthing excluded.

 prodotto conforme alle direttive europee · produced in compliance with ec directives

 marchio di certificazione europea. certifica che il prodotto è conforme alle norme europee sulla sicurezza  
component approved for north american market and suitable to be used and approved as part of a more complex system

 componente certificato per il mercato nord americano idoneo ad essere utilizzato e valutato come parte di in un sistema più complesso  
component approved for north american market and suitable to be used and approved as part of a more complex system

 apparecchio di illuminazione approvato da kema · kema approved light fitting

 prodotto conforme agli standard presenti nel regno unito che regolamentano la sicurezza e la qualità dell'acqua · product complies with uk standards set out by water regulations

 apparecchio di illuminazione certificato secondo le normative vigenti in polonia che regolamentano i dispositivi di sicurezza antincendio  
certified light fitting according to the regulations about devices for fire safety in force in poland

 prodotto idoneo per essere commercializzato nel mercato cinese · product suitable for the china market

 prodotto finito idoneo per essere commercializzato nel mercato nord americano · listed product suitable for the north american market

 prodotto conforme alla legislazione vigente nel regno unito · produced in compliance with UK legislation

 apparecchio di illuminazione certificato per il mercato cinese  
light fitting certified for china market

-  *vetro opalino* · opal glass
-  *vetro sabbiato* · sanded glass
-  *vetro nero fumè* · black smoke glass
-  *vetro trasparente* · transparent glass
-  *vetro bianco latte* · white milk glass
-  *crystallo* · crystal
-  *polycarbonato opalino* · opal polycarbonate diffuser
-  *carrabile* · drive over
-  *alimentatore incluso* · power supply included
-  *alimentatore escluso* · power supply not included
-  **AR** *alimentatore remoto incluso* · remote power supply included
-  **Ai** *alimentatore elettronico con controllo intelligente incluso* · electronic power supply with smart control included
-  **AiR** *alimentatore elettronico con controllo intelligente incluso, da installare remoto* · electronic power supply with smart control included, to be installed remotely
-  **AS** *alimentatore a spina incluso* · plug power supply included
-  **T** *trasformatore incluso* · transformer included
-  **T** *trasformatore escluso* · transformer not included
-  **K** *kit di cablaggio* · wiring kit
-  **K** *kit di cablaggio escluso* · wiring kit not included
-  **L** *lampadina con sorgente elettronica led, ad incandescenza, alogena o fluorescente inclusa.*  
bulb with led electronic source, incandescent, halogen or fluorescent included.
-  **L** *lampadina con sorgente elettronica led, ad incandescenza, alogena o fluorescente esclusa.*  
bulb with led electronic source, incandescent, halogen or fluorescent not included.
-  **Pr** *propulsore dinamico n55 incluso* · included
-  **Pr** *propulsore dinamico n55 escluso* · not included
-  **df** *diffusore incluso* · diffuser included
-  **df** *diffusore escluso* · diffuser not included
-  **⚡** *possibilità di combinazione tra interfaccia n55, propulsore dinamico n55 e lampadina n55* · possible combination between n55 interface, propulsore dinamico n55 and n55 bulb
-  **⚠** *attenzione: sorgente luminosa led. non guardare mai direttamente a occhio nudo* · attention: led light source. never look straight without eye protection
-  **ff** *flicker free compatibile con fotocamere digitali* · flicker free digital camera friendly
- l.d.** *luce diretta* · direct light
- l.i.** *luce indiretta* · indirect light
- .d1** *dimmerazione 1-10V* · 1-10V dimmable
- .d2** *dimmerazione dali* · dimmable dali
- .SA** *kit luce + emergenza sempre accese. attenzione: non è possibile installare nelle cassaforme laterizio*  
light kit + permanently lit emergency lamp. please note: cannot be installed in brickwork housing
- .SE** *solo emergenza sempre accesa. attenzione: non è possibile installare nelle cassaforme laterizio*  
permanently lit emergency lamp only. please note: cannot be installed in brickwork housing
-  **i** *peso netto* · net weight (kg)



*sistema modulare da terra per interni IP20.*

*realizzato in alluminio ossidato, con base in acciaio diametro Ø350mm.*

*modelli:*

*sempreluce telescopico con stelo regolabile diametro Ø20mm max h.1820mm, cablato con sorgente elettronica 2700K 14W 1580lm, disponibile con lampadina classica hm02, semprenudo con stelo fisso diametro Ø20mm h.1600mm con ganci porta abiti,*

*cablato con sorgente elettronica 2700K 14W 1580lm, disponibile con lampadina classica hm02,*

*sempretuo con stelo fisso diametro Ø20mm h.1600mm con ripiani di appoggio, cablato con sorgente elettronica 2700K 14W 1580lm, disponibile con lampadina classica hm02,*

*sempretavolo con base diametro Ø350mm h.600mm cablato con sorgente elettronica 2700K 10W 1580lm, disponibile con lampadina classica hm02.*

*accessori: paralume in seta blu, bianco, verde, tortora, nera.*

*sempreio con specchio 350mm h.1690mm retroilluminato con sorgente elettronica lineare 2700K 38W 3654lm,*

*sempreleggo h.1500 cablato con sorgente elettronica 2700K 1,9W 260lm,*

*sempreinfila dissuasore diametro Ø350mm h.700mm con corda blu 10000mm,*

*sempreseduto con seduta diametro Ø350mm h.455mm,*

*sempreappoggio 01 h.490mm, Ø350mm,*

*sempreappoggio 02 h.650mm, Ø350mm,*

*sempreappoggio 03 h.1000mm, Ø350mm,*

*accessori: coperture ripiano acciaio specchiante, bianco e blu e ripiani*

*sempremangio diametro Ø750mm h.720mm.*

*alimentatore 110-240V 50-60Hz fornito con spine eu/uk/usa-jp/ccc/aus e cavo 2000mm.*

*finiture: n55 e argento hacca*

*IP20-rated modular floor system for indoor use.*

*made of oxidised aluminium, with diameter Ø350mm steel base.*

*versions:*

*sempreluce telescopico with diameter Ø20mm adjustable rod up to h.1820mm, wired with*

*2700K 14W 1580lm led source, available with hm02 classic bulb,*

*semprenudo with diameter Ø20mm h.1600mm fixed rod and clothes hooks, wired with 2700K 14W 1580lm led source, available with hm02 classic bulb,*

*sempretuo with diameter Ø20mm h.1600mm fixed rod and support shelves, wired with 2700K 14W 1580lm led source, available with hm02 classic bulb,*

*sempretavolo with diameter Ø50mm h.600mm wired with 2700K 10W 1580lm led source, available with hm02 classic light bulb.*

*accessories: blue, white, green, taupe, black silk lampshade.*

*sempreio with 350mm h.1690mm backlit mirror with 2700K 38W 3654lm linear led source,*

*sempreleggo h.1500mm wired with 2700K 1,9W 260lm led source,*

*sempreinfila bollard diameter Ø350mm h.700mm with 10000mm blue rope;*

*sempreseduto diameter Ø350mm h.455mm seat,*

*sempreappoggio 01 h.490mm, Ø350mm*

*sempreappoggio 02 h.650mm, Ø350mm*

*sempreappoggio 03 h.1000mm, Ø350mm*

*accessories: mirrored steel, white and blue shelf covers and shelves*

*sempremangio diameter Ø750mm h.720mm.*

*110-240V 50-60Hz power supply with eu/uk/usa-jp/ccc/aus plugs and 2000mm cable. finishes:*

*nero55 and argento hacca.*











**sempreluce telescopico**

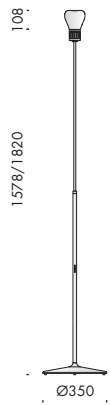

**semprenudo**

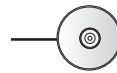
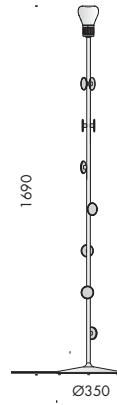

**sempretuo**

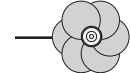
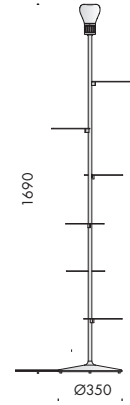

**sempretavolo**

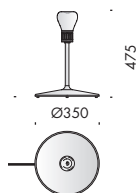

**sempreio**

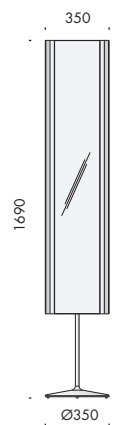

**sempreleggo**

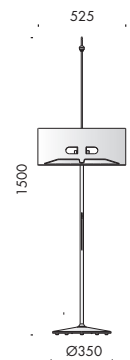



**sempremangio**

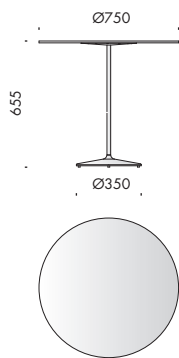

**sempreinfilata**

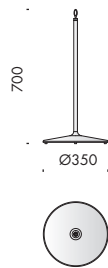

**sempreseduto**

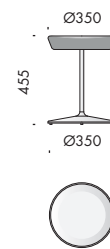

**sempreappoggio 01**

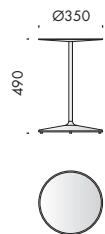

**sempreappoggio 02**

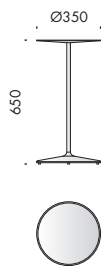

**sempreappoggio 03**

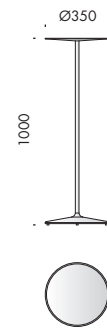

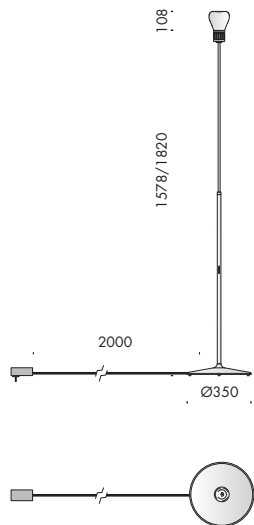
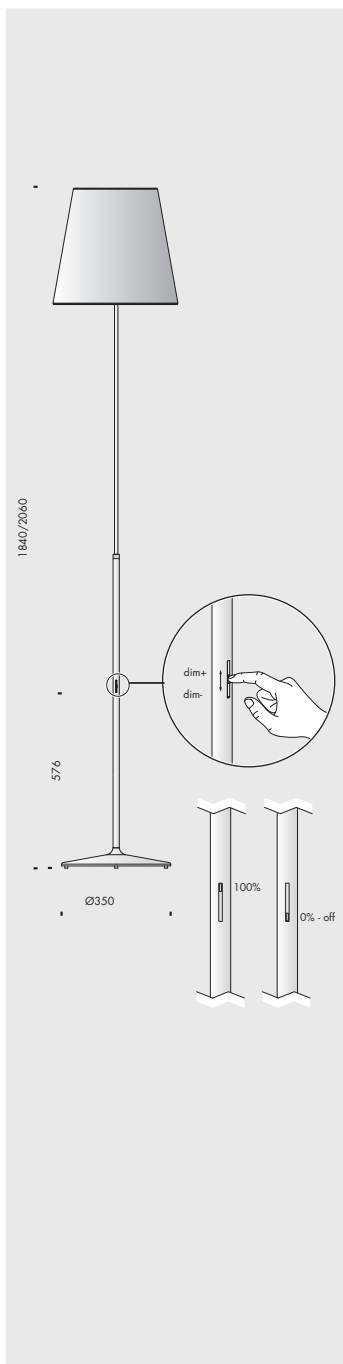

sempreluce telescopico hm02 110-240V 50-60Hz AS IP20 PR df CE

**Vb4.596.56** nero55 sabbiato · sanded 2700K 16

**Vb4.596.57** argento hacca sabbiato · sanded 2700K 16

Ra	R9	ies tm-30	sdcM	mA	V <sub>f (min)</sub>	lm	W	lm/W
98	98	Rf 96 Rg 103	step 1	500	27,9	1580	14,0	113
xm000	les19	● Ta25 °C	vita media · average life	70000 h	L80 B10			

#### paralumi. lampshades.



<b>Vb9.596.701</b>	seta bianca, doppia accoppiatura, attacco inferiore white silk, double coupling, bottom attachment	0,2
<b>Vb9.596.702</b>	seta blu, doppia accoppiatura, attacco inferiore blue silk, double coupling, bottom attachment	0,2
<b>Vb9.596.703</b>	seta verde, doppia accoppiatura, attacco inferiore green silk, double coupling, bottom attachment	0,2
<b>Vb9.596.704</b>	seta tortora, doppia accoppiatura, attacco inferiore turtledove silk, double coupling, bottom attachment	0,2
<b>Vb9.596.705</b>	seta nera, doppia accoppiatura, attacco inferiore black silk, double coupling, bottom attachment	0,2



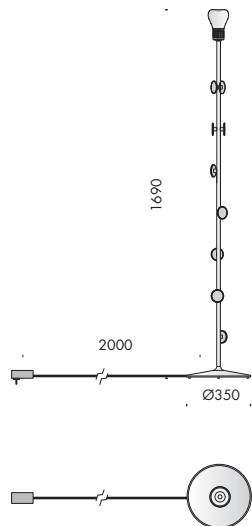
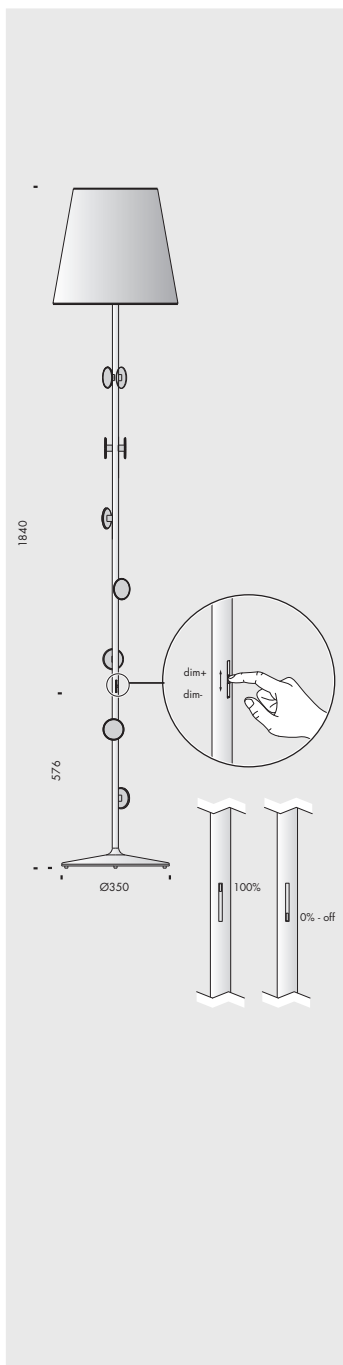

**semprenudo hm02** 110-240V 50-60Hz AS IP20 PR df CE

**Vb4.596.29** nero55 sabbiato · sanded 2700K 21

**Vb4.596.30** argento hacca sabbiato · sanded 2700K 21

Ra	R9	ies tm-30	sdcM	mA	V <sub>f (min)</sub>	lm	W	lm/W
98	98	Rf 96 Rg 103	step 1	500	27,9	1580	14,0	113
xm000	les19	● Ta25 °C	vita media · average life	70000 h	L80 B10			

**paralumi. lampshades.**

★ UK CE

- Vb9.596.701** seta bianca, doppia accoppiatura, attacco inferiore  
white silk, double coupling, bottom attachment 0,2
- Vb9.596.702** seta blu, doppia accoppiatura, attacco inferiore  
blue silk, double coupling, bottom attachment 0,2
- Vb9.596.703** seta verde, doppia accoppiatura, attacco inferiore  
green silk, double coupling, bottom attachment 0,2
- Vb9.596.704** seta tortora, doppia accoppiatura, attacco inferiore  
turtledove silk, double coupling, bottom attachment 0,2
- Vb9.596.705** seta nera, doppia accoppiatura, attacco inferiore  
black silk, double coupling, bottom attachment 0,2



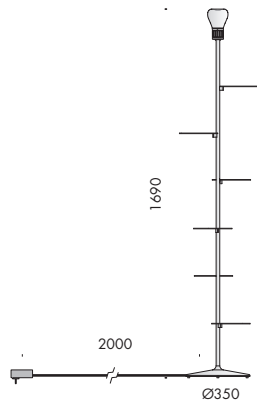
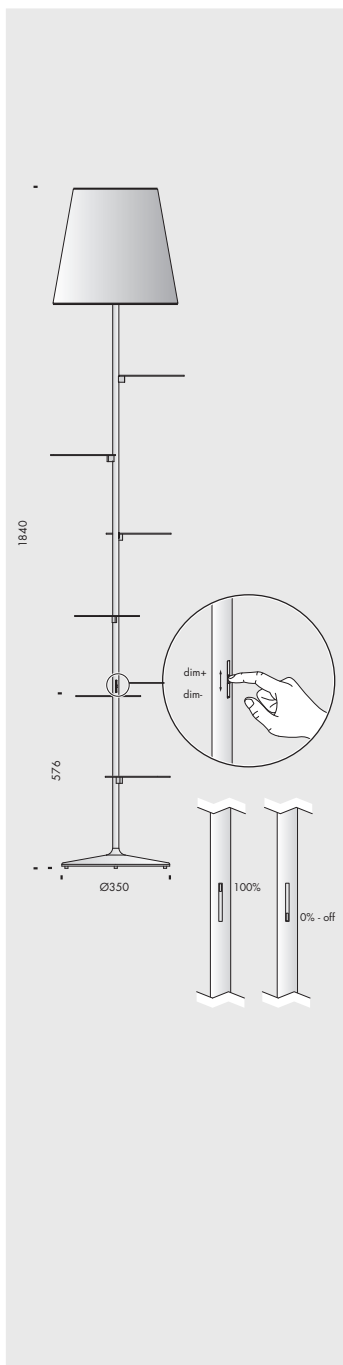

**semprefuo hm02** 110-240V 50-60Hz AS IP20 PR df CE

**Vb4.596.03** nero55 sabbiato · sanded 2700K 17

**Vb4.596.04** argento hacca sabbiato · sanded 2700K 17

Ra	R9	ies tm-30	sdcM	mA	V <sub>f(min)</sub>	lm	W	lm/W
98	98	Rf 96 Rg 103	step 1	500	27,9	1580	14,0	113
xm000	les19	● Ta25 °C	vita media · average life	70000 h	L80 B10			

**paralumi. lampshades.**

★ UK CE

- Vb9.596.701** seta bianca, doppia accoppiatura, attacco inferiore 0,2  
white silk, double coupling, bottom attachment
- Vb9.596.702** seta blu, doppia accoppiatura, attacco inferiore 0,2  
blue silk, double coupling, bottom attachment
- Vb9.596.703** seta verde, doppia accoppiatura, attacco inferiore 0,2  
green silk, double coupling, bottom attachment
- Vb9.596.704** seta tortora, doppia accoppiatura, attacco inferiore 0,2  
turtledove silk, double coupling, bottom attachment
- Vb9.596.705** seta nera, doppia accoppiatura, attacco inferiore 0,2  
black silk, double coupling, bottom attachment





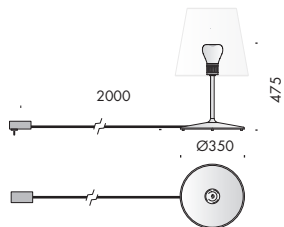
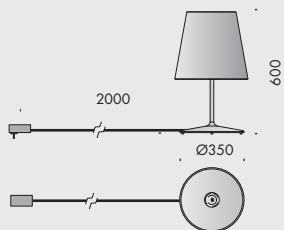

**sempre pronti tavolo hm02** 110-240V 50-60Hz AS IP20 PR df CE i

**Vb4.596.201** nero55 2700K 6

**Vb4.596.202** argento hacca 2700K 6

Ra	R9	ies tm-30	sdcM	mA	V <sub>f (min)</sub>	lm	W	lm/W
98	98	Rf 96 Rg 103	step 1	500	27,9	1580	14,0	113
xm000	les19	● Ta25 °C	vita media · average life	70000 h	L80 B10			

**paralumi. lampshades.**

★ UK CE i

<b>Vb9.596.701</b>	seta bianca, doppia accoppiatura, attacco inferiore white silk, double coupling, bottom attachment	0,2
<b>Vb9.596.702</b>	seta blu, doppia accoppiatura, attacco inferiore blue silk, double coupling, bottom attachment	0,2
<b>Vb9.596.703</b>	seta verde, doppia accoppiatura, attacco inferiore green silk, double coupling, bottom attachment	0,2
<b>Vb9.596.704</b>	seta tortora, doppia accoppiatura, attacco inferiore turtledove silk, double coupling, bottom attachment	0,2
<b>Vb9.596.705</b>	seta nera, doppia accoppiatura, attacco inferiore black silk, double coupling, bottom attachment	0,2





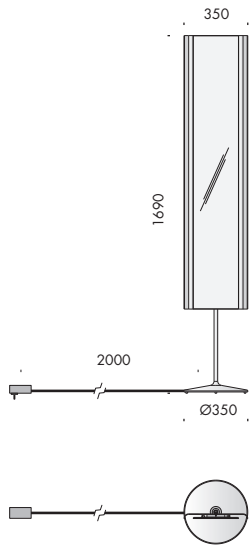
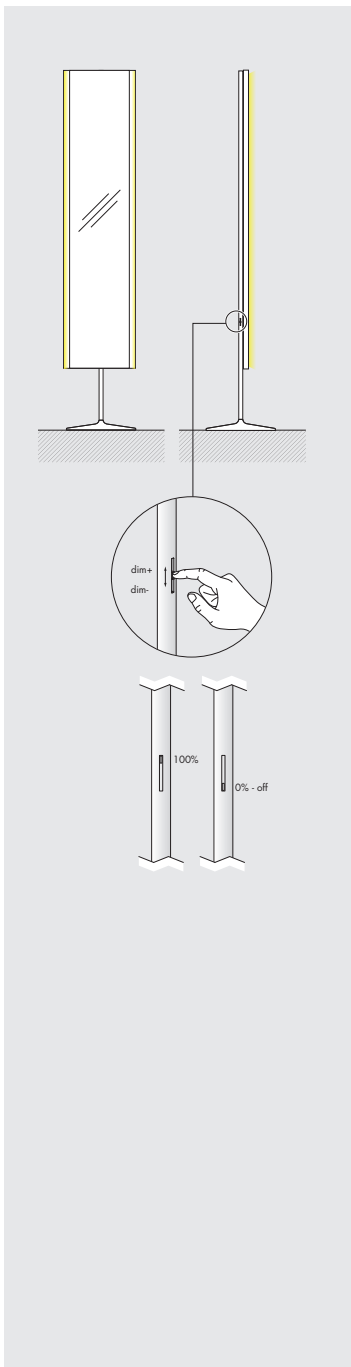

**sempreio** 110-240V 50-60Hz **AS** **IP20** **UK** **CE** **i**

**Vb4.596.116** nero55 2700K 38W 31

**Vb4.596.117** argento hacca 2700K 38W 31

Ra	R9	ies tm/30		sdc	Vf	lm/m	W/m	lm/W
95	90	Rf 90	Rg 98	step 2	48	1200	13	92
V0010	5,9	Ta25 °C		vita media · average life		50000 h	L80 B10	



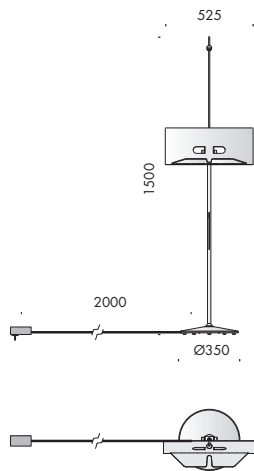

sempreleggo

110-240V 50-60Hz



IP20



**Vb4.596.124** nero55

2700K 15

**Vb4.596.125** argento hacca

2700K 15

Ra	R9	ies tm-30		sdc	mA	V <sub>f(min)</sub>	lm	W	lm/W
98	95	Rf 95	Rg 100	step 2	125	15,2	260	1,9	137
cd040	les6	Ta25 °C		vita media · average life		50000 h	L70 B10		



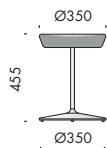
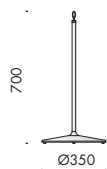

**sempreinfila** ☆ CE ⓘ

**Vb4.596.137** nero55 2 pz · pcs 15

**Vb4.596.138** argento hacca 2 pz · pcs 15

**corda. rope.** ☆ CE ⓘ

**Vb9.596.139** corda blu mn · blu mn rope 10000mm 0,5

**sempreseduto** ☆ CE ⓘ

**Vb4.596.142** nero55 legno blu mn  
blu mn wood 20

**Vb4.596.143** argento hacca legno blu mn  
blu mn wood 20



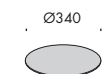
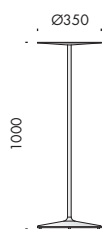
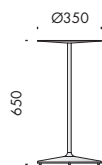
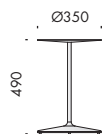
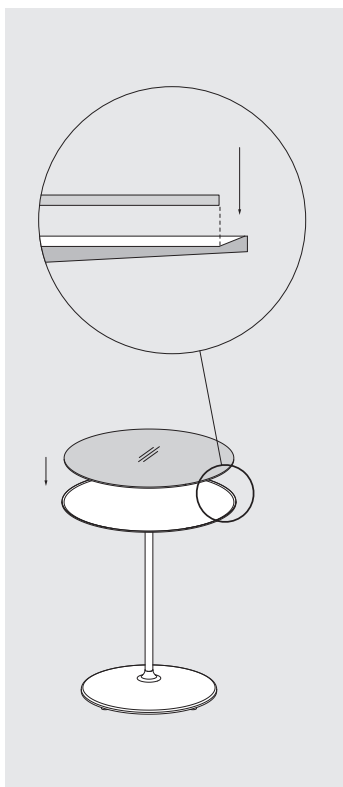

**sempreappoggio 01** ★ CE ⓘ

**Vb4.596.146** nero55 15

**Vb4.596.147** argento hacca 15

**sempreappoggio 02** ★ CE ⓘ

**Vb4.596.150** nero55 16

**Vb4.596.151** argento hacca 16

**sempreappoggio 03** ★ CE ⓘ

**Vb4.596.153** nero55 17

**Vb4.596.154** argento hacca 17

**accessori. accessories** ★ CE ⓘ

**Vb4.596.157** copertura ripiano acciaio specchiante  
mirror steel shelf cover 0,5

**Vb4.596.158** copertura ripiano bianco  
white shelf cover 0,5

**Vb4.596.159** copertura ripiano blu mn  
blu mn shelf cover 0,5



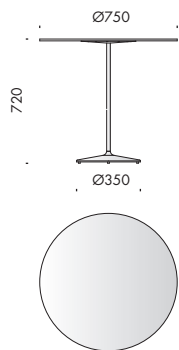

sempremangio			☆	CE	👤
<b>Vb4.596.162</b>	nero55	ripiano blu mn blu mn shelf			25
<b>Vb4.596.163</b>	argento hacca	ripiano blu mn blu mn shelf			25



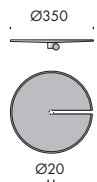

**accessori. accessories.** ☆ CE ⓘ

**Vb4.596.170** ripiano · shelf    nero55    foro Ø20mm    1,5

**Vb4.596.171** ripiano · shelf    argento hacca    foro Ø20mm    1,5

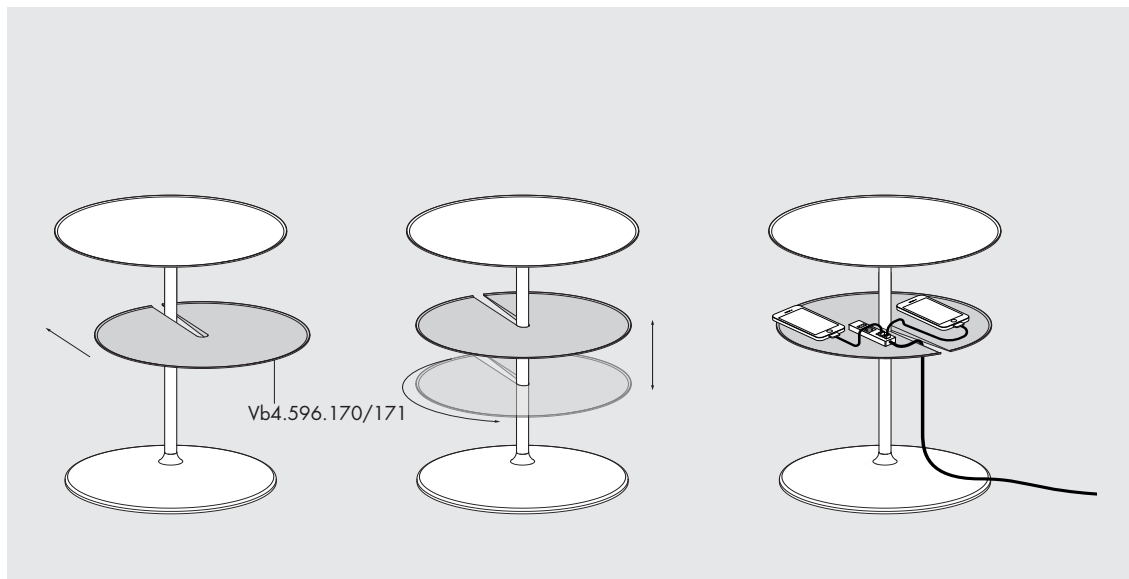

Vb4.596.170/171

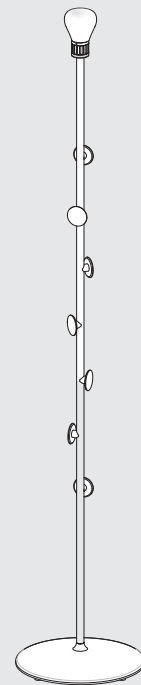
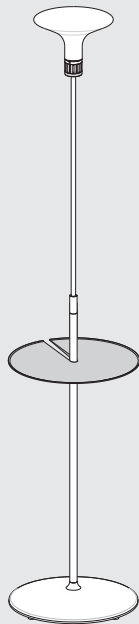
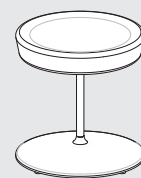
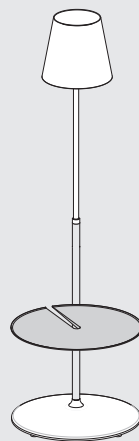
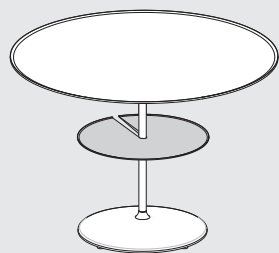
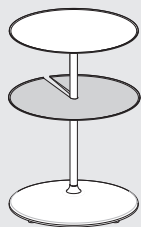

personalizza la tua luce  
vai su [Viabizzuno.com](http://Viabizzuno.com)

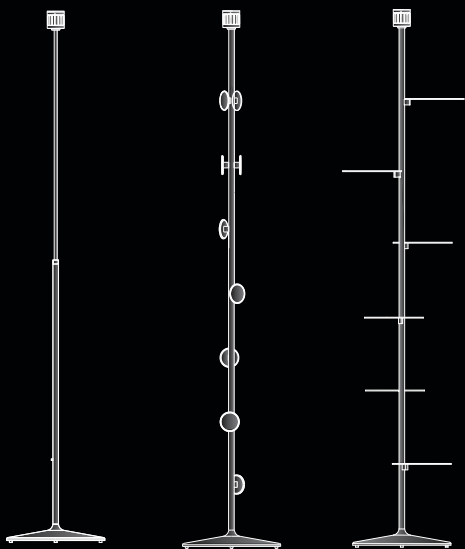

+



***diffusore classico***  
**classic diffuser**



***diffusore decorativo***  
**decorative diffuser**



***diffusore tecnico***  
**technical diffuser**

**1. scegli l'interfaccia**  
**choose the interface**

**2. scegli il tuo diffusore**  
**choose your diffuser**

sempre luce telescopico

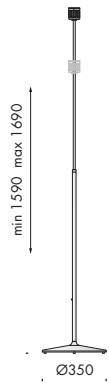

semprenudo

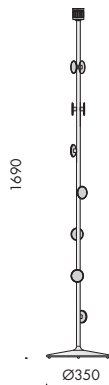

sempretuo

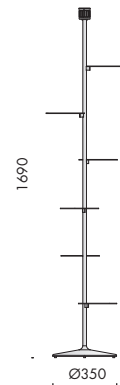

hm01 



hm02 



**diffusore decorativo  
decorative diffuser**

**diffusore tecnico  
technical diffuser**

**mn01**

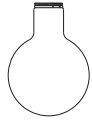

**mn06**



**dc01**



**dc02**



**dc02**



**tc01**

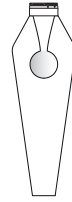

**spot55x61**



les19 ●

87°

30° 38°

36° 47°

les9 ●

18° 23° 36°



les19 ●

31° 42°

23° 37° 46°

les9 ●

13° 19° 23° 35°

**pz01** ☾☽

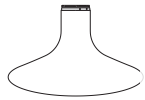

**pz03** ☾☽



**ddp01** ☾☽



**mk01** ☾☽

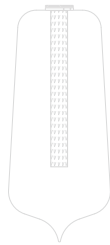

**gt01** ☾☽

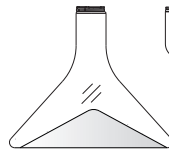

**kk01** ☾☽



les19 ●

16° 25° 40° 54°

les9 ●

10° 22°

**oma03** ☾☽

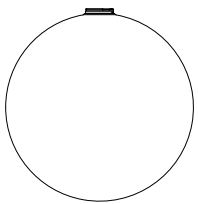

**ms02** ☾☽



**ms03** ☾☽



**ms04** ☾☽



les19 ●

22° 51°

les9 ●

13°

**wm01** ☾☽



**ajp01** ☾☽



**lensoptica amp180** ☾☽



les19 ●

15° 41° 53° 20°x55°

les9 ●

10°

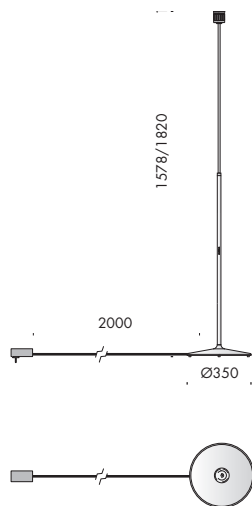

**sempreluce telescopico** 110-240V 50-60Hz AS IP20

**Vb3.596.301** nero55 2700K 16

**Vb3.596.302** argento hacca 2700K 16

Ra	R9	ies tm-30		sdc	mA	V <sub>f(min)</sub>	lm	W	lm/W
98	98	Rf 96	Rg 103	step 1	500	27,9	1580	14,0	113
xm000	les19 ● Ta25 °C		vita media · average life			70000 h	L80	B10	

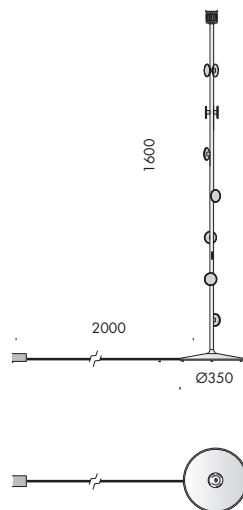

**semprenudo** 110-240V 50-60Hz AS IP20

**Vb3.596.303** nero55 2700K 21

**Vb3.596.304** argento hacca 2700K 21

Ra	R9	ies tm-30		sdc	mA	V <sub>f(min)</sub>	lm	W	lm/W
98	98	Rf 96	Rg 103	step 1	500	27,9	1580	14,0	113
xm000	les19 ● Ta25 °C		vita media · average life			70000 h	L80	B10	



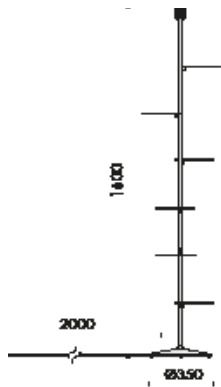

sempretuo

110-240V 50-60Hz



IP20



**Vb3.596.305** nero55

2700K 17

**Vb3.596.306** argento hacca

2700K 17

Ra	R9	ies tm-30		sdc	mA	V <sub>f (min)</sub>	lm	W	lm/W
98	98	Rf 96	Rg 103	step 1	500	27,9	1580	14,0	113
xm000	les19	Ta25 °C		vita media · average life			70000 h	L80	B10



**paralumi. lampshades.**

★ ENEC CE

<b>Vb9.596.701</b>	seta bianca, doppia accoppiatura, attacco inferiore white silk, double coupling, bottom attachment	0,2
<b>Vb9.596.702</b>	seta blu, doppia accoppiatura, attacco inferiore blue silk, double coupling, bottom attachment	0,2
<b>Vb9.596.703</b>	seta verde, doppia accoppiatura, attacco inferiore green silk, double coupling, bottom attachment	0,2
<b>Vb9.596.704</b>	seta tortora, doppia accoppiatura, attacco inferiore turtledove silk, double coupling, bottom attachment	0,2
<b>Vb9.596.705</b>	seta nera, doppia accoppiatura, attacco inferiore black silk, double coupling, bottom attachment	0,2

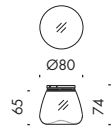

**Vb9.580.01.t** hm01 trasparente · transparent

n55 0,05

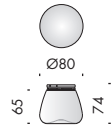

**Vb9.580.01.s** hm01 sabbziata · sanded

n55 0,05

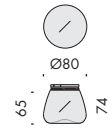

**Vb9.580.01.b** hm01 bianco latte · milk white

n55 0,05

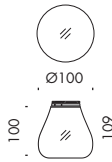

**Vb9.580.02.t** hm02 trasparente · transparent

n55 0,1

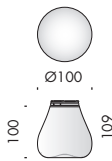

**Vb9.580.02.s** hm02 sabbziata · sanded

n55 0,1

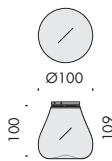

**Vb9.580.02.b** hm02 bianco latte · milk white

n55 0,1

marionanni

★ UK CE i

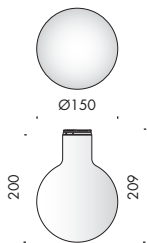

**Vb9.580.03.s** mn01 sabbiato · sanded

n55 0,3

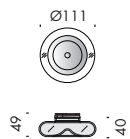

**Vb9.580.173.b** mn06 tabacchiera  
bianco satinato · white frosted

n55 0,1

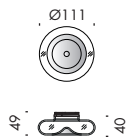

**Vb9.580.173.cr** mn06 tabacchiera  
trasparente cromata · transparent chromed

n55 0,1

david chipperfield



**Vb9.580.05.s** dc01 sabbaiato · sanded

n55 0,1



**Vb9.580.06.s** dc02 sabbaiato · sanded

n55 0,3



peter zumthor

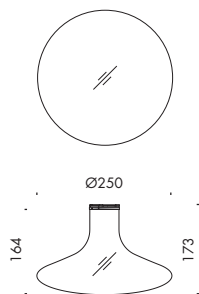

**Vb9.580.08.t** pz01 trasparente · transparent

n55 0,3

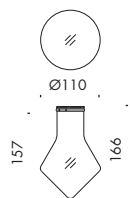

**Vb9.580.11.t** pz03 trasparente · transparent

n55 0,2

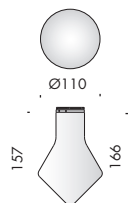

**Vb9.580.11.s** pz03 sabbiato · sanded

n55 0,2

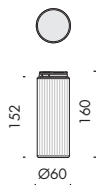

### al-jawad pike



**Vb9.580.18.tr** aip01 trasparente, rigato · transparent, striped n55 0,2

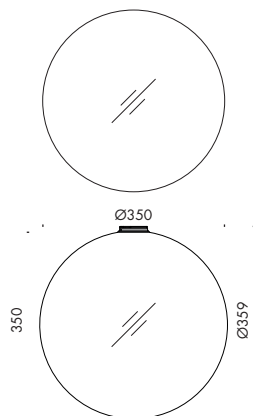

### oma



**Vb9.580.15.t** oma03 trasparente · transparent n55 1,4

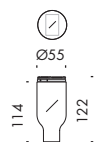

### kengo kuma



**Vb9.580.07.c** kk01 cristallo · crystal n55 0,3

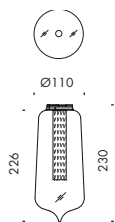

**marcio kogan**



**Vb9.580.111.t** mk01 trasparente · transparent

n55 0,4

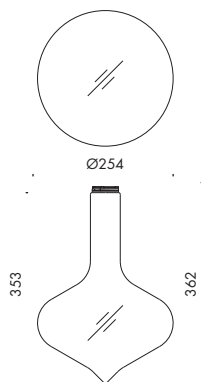

**rdai**

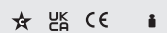

**Vb9.580.12.t** rdai01 trasparente · transparent

n55 0,6

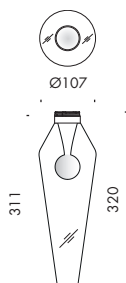

**tzach cohen**



**Vb9.580.180.ts** tc01 trasparente, sabbiato · transparent, sanded

n55 0,4

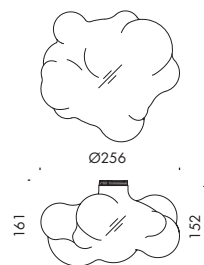

winy maas

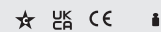

Vb9.580.09.t wm01 trasparente · transparent

n55 0,6

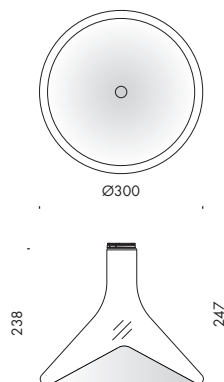

gio tirotto



Vb9.580.17.t gt01 trasparente, sabbaiato · transparent, sanded

n55 1

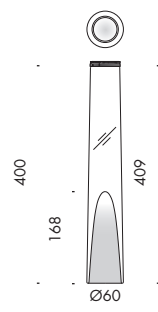

domenico de palo

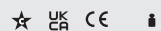

Vb9.580.114.t ddp01 trasparente, sabbaiato · transparent, sanded

n55 0,5



mirko spaccapanico

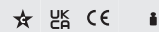

**Vb9.580.175.t** ms02 trasparente · transparent

n55 0,2



**Vb9.580.176.t** ms03 trasparente · transparent

n55 0,2

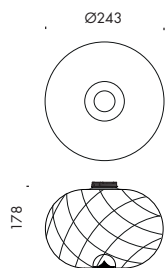

**Vb9.580.177.t** ms04 trasparente · transparent

n55 0,5

accessori per diffusore trasparente. transparent diffuser accessories. ☆ UK CE i



**Vb9.580.160** trappola di luce antiabbagliamento nero  
anti-glare black light trap

0,03

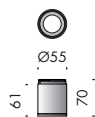
**spot55x61**



<b>Vb9.580.25</b>	argento hacca	36° les19 ●	n55	0,2
<b>Vb9.580.26</b>	nero55	36° les19 ●	n55	0,2
<b>Vb9.580.26.b</b>	my bianco	36° les19 ●	n55	0,2
<b>Vb9.580.27</b>	argento hacca	47° les19 ●	n55	0,2
<b>Vb9.580.28</b>	nero55	47° les19 ●	n55	0,2
<b>Vb9.580.28.b</b>	my bianco	47° les19 ●	n55	0,2

**accessori spot55. accessories.**

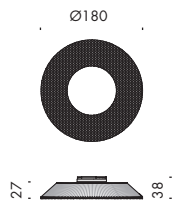

<b>Vb9.580.91</b>	frangiluce nido d'ape · honeycomb louvre			0,01
<b>Vb9.580.92</b>	lente ellittica · elliptical lens			0,04

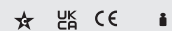

### lensoptica amP180

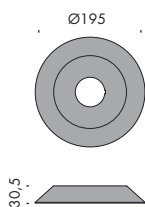

<b>Vb9.518.81</b>	fascio stretto narrow beam	10° les9 ●	n55	0,6
		15° les19 ●		
<b>Vb9.518.82</b>	fascio medio medium beam	41° les19 ●	n55	0,6
<b>Vb9.518.83</b>	fascio largo wide beam	53° les19 ●	n55	0,6



### riflettore in metallo 180



<b>Vb9.518.96.n</b>	nero55	0,1
<b>Vb9.518.96.mb</b>	my bianco	0,1
<b>Vb9.518.96.h</b>	argento hacca	0,1