

Viabizzuno strada principale della frazione di bizzuno in provincia di ravenna dove tra la casa del popolo e la parrocchia, al n°17, sono nato il ventuno luglio millenovecentocinquantacinque. da qui nasce il nome della fabbrica di produzione fondata nel millenovecentonovantaquattro rappresentata da uno spazio bianco attraversato da due linee. una verticale, rigorosa, essenziale, equilibrata: la luce per la luce; ed una inclinata, irriverente nello spazio, ironica, fuori dagli schemi: la luce per la forma. distinte ma complementari si fondono in un unico nome: Viabizzuno.

Viabizzuno is the name of the main road of the small village bizzuno located in the province of ravenna, where I was born on the twenty-first july nineteenfiftyfive at n°17, between the 'casa del popolo' and the local parish church. from here the name of the factory founded in nineteen ninety-four represented by a white space intersected by two lines. one vertical, well balanced, logical, essential: the light for the light. the other one dynamic, irreverent, ironic: the light for the form. separate and yet complementary they cast in the same name: Viabizzuno. marionanni

*i progetti rendono gli oggetti eterni,
le mode li corrompono, gli imbecilli li copiano
e li vendono agli ignoranti e ai deficienti.
noi progettiamo e lavoriamo per aiutare la luce
ad emozionarvi.*

*i frutti delle nostre idee e dei nostri progetti
sono protetti da brevetti
e/o modelli registrati
e/o da diritto d'autore.*

design makes objects timeless,
fashion corrupts them,
fools copy them and sell them to
ignorants and idiots.
we do projects and work to help light to bring
you true emotion.
the results of our ideas and our projects
are protected by patents
and/or registered models
and/or copyright.

al fine di offrire ai nostri clienti la massima qualità della luce utilizzando le più avanzate tecnologie, forti del nostro sapere artigiano costruito in italia, aggiorniamo costantemente i nostri apparecchi di illuminazione.

Viabizzuno si riserva il diritto di apportare ai propri modelli, senza nessun preavviso, qualsiasi modifica ritenesse opportuna. per dimensioni e codici fanno fede i nostri strumenti di lavoro www.Viabizzuno.com, Viacommerce@, Viabizzunoapplight e Viabizzunoonline.

in order to provide to our customers the maximum quality of light using the most advanced technologies, being strong of our artisan knowledge made in italy, we constantly update our lighting fixtures.

Viabizzuno reserves the right to make any modification, considered worthwhile, to its own models, without any notification. for valid dimensions and codes please consult our working tools www.Viabizzuno.com, Viacommerce@, Viabizzunoapplight and Viabizzunoonline.

lettura delle tabelle tecniche how to read technical tables

XXXXXXXXXXXXXXXXXX										
230V 50-60Hz				A	⊕	IP66		US	CE	
a	b	c	d	e	f	g	g	h	i	

XXXXXXXXXXXXXXXXXX										
230V 50-60Hz				A	⊕	IP66		US	CE	
Vbx.xxx.xx	nero55	3000K		35W	1,5					
l	m	n	o	i						

componenti. components.	IK10	CE	
--------------------------------	------	----	--

accessori. accessories.	IK10	CE	
--------------------------------	------	----	--

1	2	3	4	5	6	7	8	9	10
---	---	---	---	---	---	---	---	---	----

Ra	R9	ies tm/30		sdcM	Vf	lm/m	W/m	lm/W	
95	90	Rf 90	Rg 98	step 2	24	1200	13	92	F
V0000	5,9		Ta25 °C	vita media · average life	50000 h	L80	B10		

11	12	13	14
----	----	----	----

bandella tecnica. posizioni standard simbologie.
data plate. standard arrangement of symbols.

a	nome apparecchio di illuminazione · light fitting name
b	tensione di alimentazione · supply rating (Volt)
c	frequenza di alimentazione · supply frequency (Hertz)
d	alimentatore incluso o escluso · power supply included or not included
e	classe di isolamento · insulation class
f	grado di protezione · protection degree
g	marchio di certificazione · safety and quality standards certification
h	conforme alle direttive europee produced in compliance with EC directives
i	peso netto · net weight (kg)
l	codice · code
m	finitura · finish
n	temperatura colore sorgente elettronica colour temperature led source (Kelvin)
o	potenza della sorgente · source power (Watt)

componenti. identifica tutti gli elementi indispensabili per la corretta funzionalità e installazione dell'apparecchio di illuminazione.
components. includes all items that are essential to the correct operation and installation of the light fitting.

accessori. si riferisce alle ulteriori parti installabili sull'apparecchio.
accessories. refers to items that can be added to the light fitting.

1	indice di resa cromatica · colour rendering index
2	indice di resa del rosso · red colour rendering index
3	Rf indice di fedeltà colore · colour fidelity index Rg indice di saturazione colore · color gamut index
4	step di macadam · macadam step
5	corrente di alimentazione · power supply current
6	tensione di alimentazione · power supply voltage
7	flusso luminoso · light flux
8	potenza della sorgente · source power
9	efficienza della sorgente · source efficiency
10	classe di efficienza energetica · efficiency class
11	codice sorgente elettronica Viabizzuno · Viabizzuno led source code
12	superficie emittente · light emitting surface (mm)
13	% flusso residuo a fine vita · end life % flux
14	% consentita sotto limite · allowed % under limit

gradi di protezione protection degrees

IP0X	<i>non protetto</i> no protection	IPX0	<i>non protetto</i> no protection		
IP1X	<i>contro corpi estranei >50 mm</i> protection against solid objects	IPX1	<i>protetto contro la caduta verticale di gocce d'acqua</i> protected against water drops falling vertically	IK01	<i>nessuna protezione</i> no protection
IP2X	<i>contro corpi estranei >12 mm</i> protection against solid objects	IPX2	<i>protetto contro la caduta di gocce con inclinazione max 15°</i> protected against water drops max inclination 15°	IK02	<i>protetto contro l'energia d'urto 0,2J</i> protected against collision energy
IP3X	<i>contro corpi estranei >2,5 mm</i> protection against solid objects	IPX3	<i>protetto contro la caduta di gocce con inclinazione max 60°</i> protected against water drops max inclination 60°	IK03	<i>protetto contro l'energia d'urto 0,35J</i> protected against collision energy
IP4X	<i>contro corpi estranei >1 mm</i> protection against solid objects	IPX4	<i>protetto contro spruzzi d'acqua</i> protected against sprinkling water	IK04	<i>protetto contro l'energia d'urto 0,5J</i> protected against collision energy
IP5X	<i>protezione da polvere</i> dust-protected	IPX5	<i>protetto contro getti d'acqua</i> protected against water jets	IK05	<i>protetto contro l'energia d'urto 0,7J</i> protected against collision energy
IP6X	<i>stagno alla polvere</i> dust-proof	IPX6	<i>protetto contro inondazioni</i> protected against flooding	IK06	<i>protetto contro l'energia d'urto 1J</i> protected against collision energy
		IPX7	<i>per breve immersione</i> protected against brief immersions	IK07	<i>protetto contro l'energia d'urto 2J</i> protected against collision energy
		IPX8	<i>per immersione prolungata</i> protected against long immersion	IK08	<i>protetto contro l'energia d'urto 5J</i> protected against collision energy
				IK09	<i>protetto contro l'energia d'urto 10J</i> protected against collision energy
				IK10	<i>protetto contro l'energia d'urto 20J</i> protected against collision energy

legenda simboli symbols key

-  *tavolo* · table
-  *terra* · floor standing
-  *soffitto* · ceiling
-  *parete* · wall
-  *sospensione* · suspension
-  *binario* · track
-  *incasso* · recessed
-  *scomparsa totale* · fully concealed
-  *segnalatica+emergenza* · signalling system+emergency
-  *portatili autoalimentati a batteria* · portable self-powered with battery
-  *sistemi* · systems
-  *palo* · pole
-  *paletto* · bollard
-  *seduta* · sitting

 *disponibile su* · available on *Viabizzuno applight* www.Viabizzuno.com *Viabizzuno online*

 *classe I. solo isolamento fondamentale, le parti conduttrici accessibili sono collegate ad un conduttore di terra. messa a terra tassativa*
class I. only basic insulation, accessible conductors are earthed. earthing compulsory

 *classe II. all'isolamento principale è aggiunto un secondo isolamento oppure ai due isolamenti è sostituito un isolamento rinforzato. messa a terra esclusa*
class II. basic insulation plus second insulation or both are replaced by reinforced insulation. earthing excluded

 *classe III. alimentazione effettuata con bassissima tensione di sicurezza; sono escluse tensioni superiori a 50V-50Hz. messa a terra non prevista.*
class III. very low safety supply tension; not to be used over 50V-50Hz. earthing excluded.

 *prodotto conforme alle direttive europee* · produced in compliance with ec directives

 *marchio di certificazione europea. certifica che il prodotto è conforme alle norme europee sulla sicurezza*
component approved for north american market and suitable to be used and approved as part of a more complex system

 *componente certificato per il mercato nord americano idoneo ad essere utilizzato e valutato come parte di in un sistema più complesso*
component approved for north american market and suitable to be used and approved as part of a more complex system

 *apparecchio di illuminazione approvato da kema* · kema approved light fitting

 *prodotto conforme agli standard presenti nel regno unito che regolamentano la sicurezza e la qualità dell'acqua* · product complies with uk standards set out by water regulations

 *apparecchio di illuminazione certificato secondo le normative vigenti in polonia che regolamentano i dispositivi di sicurezza antincendio*
certified light fitting according to the regulations about devices for fire safety in force in poland

 *prodotto idoneo per essere commercializzato nel mercato cinese* · product suitable for the china market

 *prodotto finito idoneo per essere commercializzato nel mercato nord americano* · listed product suitable for the north american market

 *prodotto conforme alla legislazione vigente nel regno unito* · produced in compliance with UK legislation

 *apparecchio di illuminazione certificato per il mercato cinese*
light fitting certified for china market

-  *vetro opalino* · opal glass
-  *vetro sabbiato* · sanded glass
-  *vetro nero fumè* · black smoke glass
-  *vetro trasparente* · transparent glass
-  *vetro bianco latte* · white milk glass
-  *crystallo* · crystal
-  *policarbonato opalino* · opal polycarbonate diffuser
-  *carrabile* · drive over
-  *alimentatore incluso* · power supply included
-  *alimentatore escluso* · power supply not included
-  *alimentatore remoto incluso* · remote power supply included
-  *alimentatore elettronico con controllo intelligente incluso* · electronic power supply with smart control included
-  *alimentatore elettronico con controllo intelligente incluso, da installare remoto* · electronic power supply with smart control included, to be installed remotely
-  *alimentatore a spina incluso* · plug power supply included
-  *trasformatore incluso* · transformer included
-  *trasformatore escluso* · transformer not included
-  *kit di cablaggio* · wiring kit
-  *kit di cablaggio escluso* · wiring kit not included
-  *lampadina con sorgente elettronica led, ad incandescenza, alogena o fluorescente inclusa.*
bulb with led electronic source, incandescent, halogen or fluorescent included.
-  *lampadina con sorgente elettronica led, ad incandescenza, alogena o fluorescente esclusa.*
bulb with led electronic source, incandescent, halogen or fluorescent not included.
-  *propulsore dinamico n55 incluso* · included
-  *possibilità di combinazione tra interfaccia n55, propulsore dinamico n55 e lampadina n55* · possible combination between n55 interface, propulsore dinamico n55 and n55 bulb
-  *attenzione: sorgente luminosa led. non guardare mai direttamente a occhio nudo* · attention: led light source. never look straight without eye protection
-  *flicker free compatibile con fotocamere digitali* · flicker free digital camera friendly
- l.d.** *luce diretta* · direct light
- l.i.** *luce indiretta* · indirect light
- .d1** *dimmerazione 1-10V* · 1-10V dimmable
- .d2** *dimmerazione dali* · dimmable dali
- .SA** *kit luce + emergenza sempre accese. attenzione: non è possibile installare nelle cassaforme laterizio*
light kit + permanently lit emergency lamp. please note: cannot be installed in brickwork housing
- .SE** *solo emergenza sempre accesa. attenzione: non è possibile installare nelle cassaforme laterizio*
permanently lit emergency lamp only. please note: cannot be installed in brickwork housing
-  *peso netto* · net weight (kg)



apparecchio di illuminazione da incasso per interni IP20.
realizzato in gesso per permettere di applicare alla superficie del corpo la stessa finitura della parete circostante utilizzando le medesime tecniche di stuccatura, rasatura o tinteggiatura di un'opera in muratura.

modelli:

stromba incasso piccolo 350x350x171mm diametro inferiore Ø220mm, cablato con sorgente elettronica Ra98 3000K 11,9W 1255lm, alimentatore 240V 50-60Hz incluso.
stromba incasso grande h.581mm diametro superiore Ø600mm, diametro inferiore Ø1000mm, cablato con sorgente elettronica Ra95 3000K 42W 4032lm 24Vdc per luce indiretta, sorgente elettronica con attacco G53 3000K fino a 15W 875lm 12V con kit luce diretta, alimentatori in tensione costante esclusi da installare remoti.
accessori: porta accessori, lente ellittica, lente diffondente e frangiluce nido d'ape.
finiture: gesso grezzo.

IP20 rated recessed light fitting for indoor use.

made of plaster so that the same finish of the surrounding wall can be applied to the fitting surface, using the same plastering, skim coating or painting techniques used for masonry.

versions:

stromba incasso piccolo (350x350x171mm) with a Ø220mm diameter at the bottom, wired with Ra95 3000K 11.9W 1250lm led source, 240V 50-60Hz power supply included.
stromba incasso grande (h.581mm) with a Ø600mm diameter at the top and a Ø1000mm diameter at the bottom, wired with Ra95 3000K 42W 4032lm 24Vdc led source for indirect light, led source with G53 3000K lamp-holder up to 15W 875lm 12V with direct light kit, constant voltage power supplies not included, to be installed remotely.
accessories: accessory carrier, elliptical lens, diffusing lens, honeycomb louvre.
finishes: raw plaster.

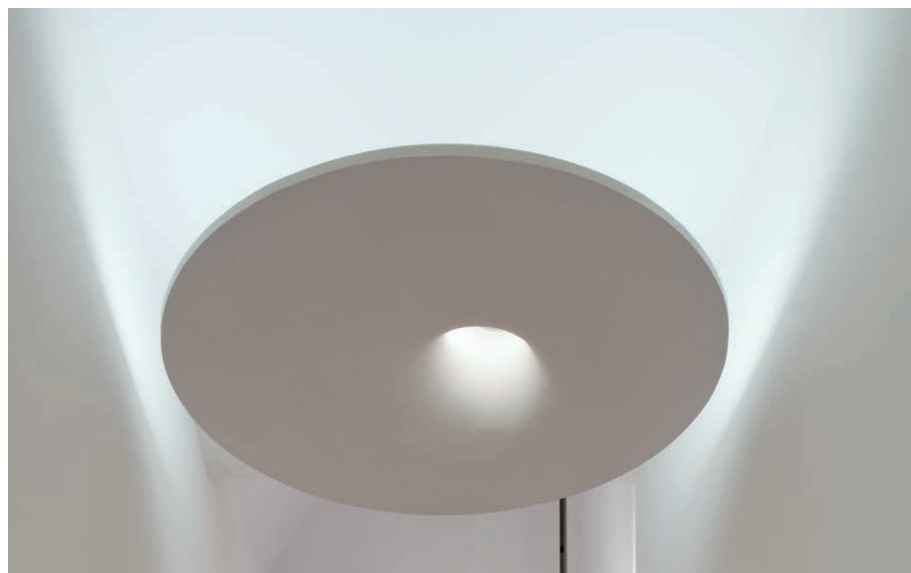
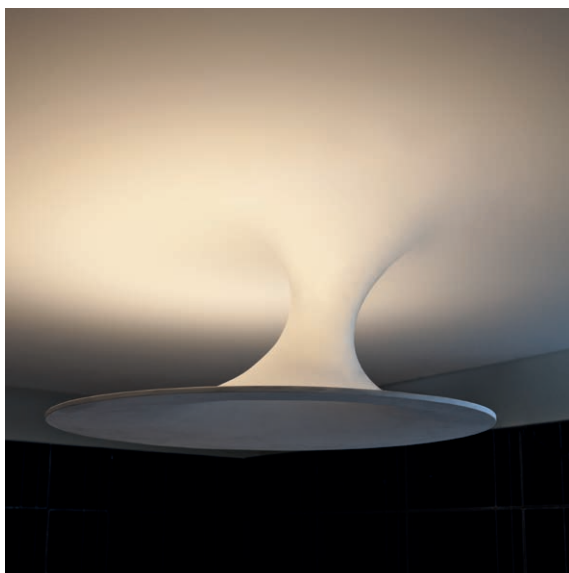

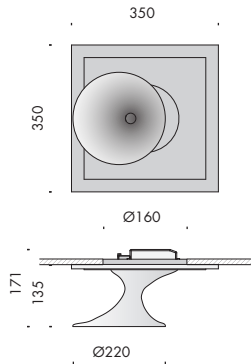

stromba incasso piccolo 240V 50-60Hz     

Vb6.563.01 gesso grezzo · raw plaster 3000K 11,9W 4,3

Ra	R9	ies tm-30		sdcn	mA	V _{f (min)}	lm	W	lm/W
98	90	Rf 93	Rg 99	step 2	350	34,0	1255	11,9	105
ce059	les12 ● Ta25 °C		vita media · average life		50000 h	L80	B10		





stromba incasso grande 24Vdc     

Vb6.563.20 gesso grezzo · raw plaster 3000K 42W 53

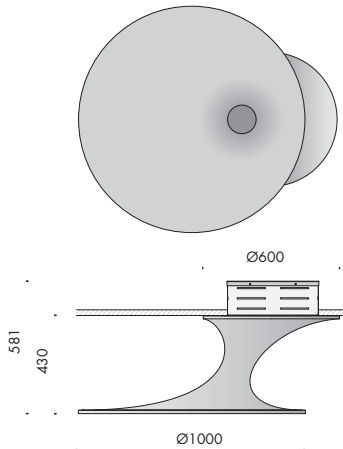
l.i. (luce indiretta · indirect light)

Ra	R9	ies tm/30		sdcn	Vf	lm/m	W/m	lm/W	
95	90	Rf 93	Rg 102	step 2	24	1250	13	96	
V0001	5,9  Ta25 °C		vita media · average life		50000 h	L80	B10		



kit luce diretta. direct light kit. 12V     

a6.563.21 nero55 G53 0,4

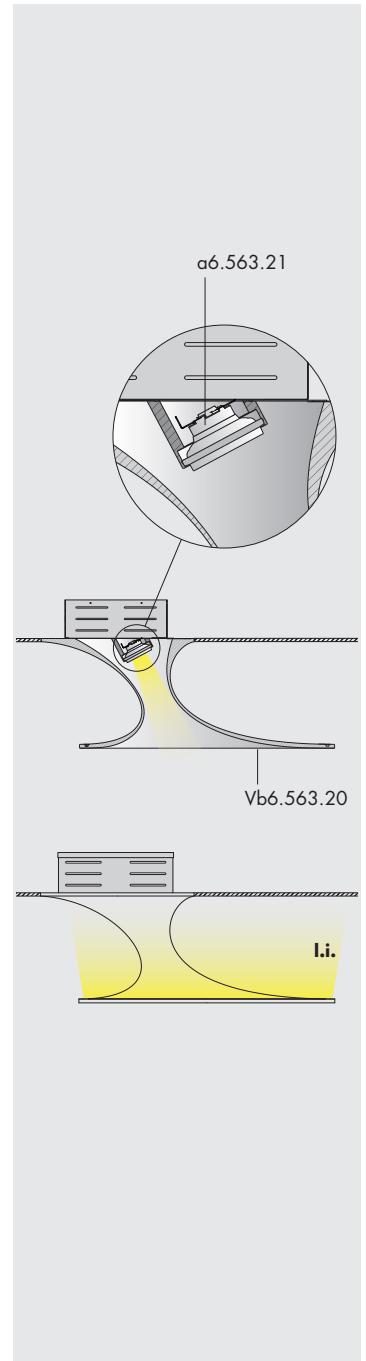

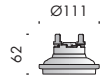

sorgente elettronica spot. led spot component. 12Vac **G53**

17.970-3	2700K	9°	0,2
17.971-3	2700K	24°	0,2
17.972-3	2700K	40°	0,2

Ra	ies tm/30		sdc	V _f	lm	W	lm/W
95	Rf 92	Rg 101	step 3	12	600	11	55
pd000	Ta25 °C vita media · average life			40000 h	L80 B10		

17.976-3	2700K	24°	0,2
17.977-3	2700K	45°	0,2

Ra	ies tm/30		sdc	V _f	lm	W	lm/W
95	Rf 92	Rg 101	step 3	12	875	15	59
pd010	Ta25 °C vita media · average life			40000 h	L80 B10		

17.973-3	3000K	9°	0,2
17.974-3	3000K	24°	0,2
17.975-3	3000K	40°	0,2

Ra	ies tm-30		sdc	V _{f(min)}	lm	W	lm/W
95	Rf 92	Rg 101	step 3	12	620	11	57
pd001	Ta25 °C vita media · average life			40000 h	L80 B10		

17.978-3	3000K	24°	0,2
17.979-3	3000K	45°	0,2

Ra	ies tm-30		sdc	V _{f(min)}	lm	W	lm/W
95	Rf 92	Rg 101	step 3	12	875	15	59
pd011	Ta25 °C vita media · average life			40000 h	L80 B10		

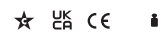
accessori. accessories.

f9.001.11 porta accessori nero · accessory carrier black 0,01

f9.001.12 porta accessori argento · accessory carrier silver 0,01



f9.001.25 lente ellittica · elliptical lens 0,04



f9.001.27 lente diffondente · diffusing lens 0,05



f9.001.31 frangiluce nido d'ape · louver honeycomb 0,01

