



Viabizzuno strada principale della frazione di bizzuno in provincia di ravenna dove tra la casa del popolo e la parrocchia, al n°17, sono nato il ventuno luglio millenovecentocinquantacinque. da qui nasce il nome della fabbrica di produzione fondata nel millenovecentonovantaquattro rappresentata da uno spazio bianco attraversato da due linee. una verticale, rigorosa, essenziale, equilibrata: la luce per la luce; ed una inclinata, irriverente nello spazio, ironica, fuori dagli schemi: la luce per la forma. distinte ma complementari si fondono in un unico nome: Viabizzuno.

marionanni

Viabizzuno is the name of the main road of the small village bizzuno located in the province of ravenna, where I was born on the twenty-first july nineteenfiftyfive at n°17, between the 'casa del popolo' and the local parish church. from here the name of the factory founded in nineteen ninety-four represented by a white space intersected by two lines. one vertical, well balanced, logical, essential: the light for the light. the other one dynamic, irreverent, ironic: the light for the form. separate and yet complementary they cast in the same name: Viabizzuno.

prodotto
product



schede tecniche
technical data sheet



curve fotometriche
photometric curves



modelli 3d per i tuoi render
3d models for your render



n22 soffitto marionanni



apparecchio di illuminazione a soffitto per interni IP20 realizzato in ottone naturale e cristallo
modelli:
n22 soffitto per boccola scomparsa totale Ø22,
n22 soffitto per boccola scomparsa totale Ø55.
lampadina n22 cablata con sorgente elettronica Ra95 2700K fino a 2,5W 700mA 240lm 2 step macadam les16
alimentatore in corrente costante escluso, da installare remoto.
cassaforma scomparsa totale esclusa
finiture: ottone naturale

IP20-rated indoor ceiling light fitting made of natural brass and crystal
versions:
n22 soffitto per boccola scomparsa totale Ø22,
n22 soffitto per boccola scomparsa totale Ø55.
n22 light bulb wired with electronic source Ra95 2700K up to 2.5W 700mA 240lm 2 step macadam les16
constant current power supply excluded, to be installed remote.
full retractable housing excluded
finishes: natural brass

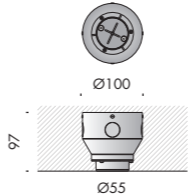
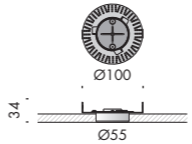
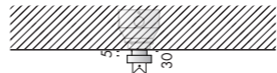
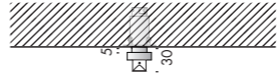

n22 soffitto scomparsa totale Ø22 IP20

Vb6.644.101 ottone naturale · natural brass 2700K 0,8

Ra	R9	ies tm-30		sdc	mA	V _f (min)	lm	W	lm/W
95	90	Rf 93	Rg 102	step 2	350	3,0	100	1	100
					700	3,1	240	2,5	96
Vz071	les16	Ta25 °C		vita media · average life		50000	h L80 B10		

cassaforma scomparsa totale. housing total recessed.

Vb9.644.701 cassaforma scomparsa totale housing total recessed 0,1

n22 soffitto scomparsa totale Ø55 IP20

Vb6.644.104 ottone naturale · natural brass 2700K 0,8

Ra	R9	ies tm-30		sdc	mA	V _f (min)	lm	W	lm/W
95	90	Rf 93	Rg 102	step 2	350	3,0	100	1	100
					700	3,1	240	2,5	96
Vz071	les16	Ta25 °C		vita media · average life		50000	h L80 B10		

rosoni di alimentazione. ceiling roses.

Vb9.580.73 cassaforma cartongesso scomparsa totale plasterboard housing total recessed 0,1

Vb9.580.74 cassaforma laterizio scomparsa totale brick housing total recessed 0,1

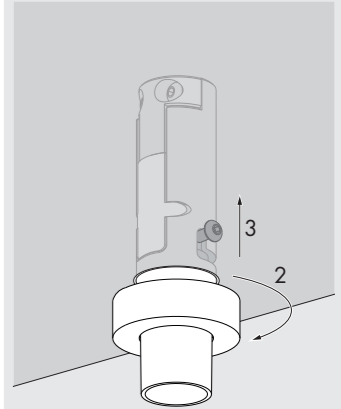
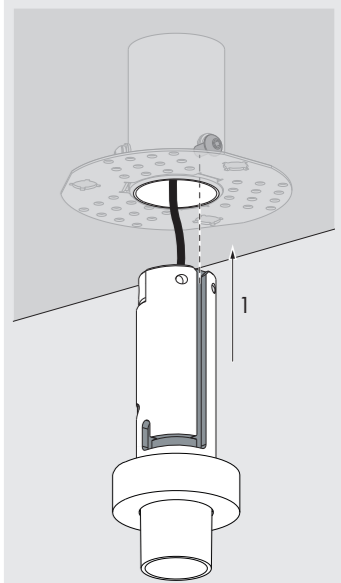

lettura delle tabelle tecniche how to read technical tables

xxxxxxxxxxxxxxxx										230V 50-60Hz		A	⊕	IP66	⚡	UL	CE	🔒
a	b	c	d	e	f	g	g	h	i									

xxxxxxxxxxxxxxxx										230V 50-60Hz		A	⊕	IP66	⚡	UL	CE	🔒	
Vbx.xxx.xx	nero55	3000K		35W						1,5									
l	m	n		o						i									

componenti. components. IK10 CE 🔒

accessori. accessories. IK10 CE 🔒

1	2	3	4	5	6	7	8	9										
Ra	R9	ies tm-30		sdcm	mA	V _{f (min)}	lm	W	lm/W									
98	98	Rf 96	Rg 103	step 1	350	27,6	1240	9,7	128									
500	27,9	1580	14,0	113														
xm000	les19	☀️	Ta25 °C	vita media · average life	70000 h	L80	B10											
10	11						12	13										

bandella tecnica. posizioni standard simbologie.
data plate. standard arrangement of symbols.

a	nome apparecchio di illuminazione · light fitting name
b	tensione di alimentazione · supply rating (Volt)
c	frequenza di alimentazione · supply frequency (Hertz)
d	alimentatore incluso o escluso · power supply included or not included
e	classe di isolamento · insulation class
f	grado di protezione · protection degree
g	marchio di certificazione · safety and quality standards certification
h	conforme alle direttive europee produced in compliance with EC directives
i	peso netto · net weight (kg)
l	codice · code
m	finitura · finish
n	temperatura colore sorgente elettronica colour temperature led source (Kelvin)
o	potenza della sorgente · source power (Watt)

componenti. identifica tutti gli elementi indispensabili per la corretta funzionalità e installazione dell'apparecchio di illuminazione.
components. includes all items that are essential to the correct operation and installation of the light fitting.

accessori. si riferisce alle ulteriori parti installabili sull'apparecchio.
accessories. refers to items that can be added to the light fitting.

1	indice di resa cromatica · colour rendering index
2	indice di resa del rosso · red colour rendering index
3	Rf indice di fedeltà colore · colour fidelity index Rg indice di saturazione colore · color gamut index
4	step di macadam · macadam step
5	corrente di alimentazione · power supply current
6	tensione di alimentazione · power supply voltage
7	flusso luminoso · light flux
8	potenza della sorgente · source power
9	efficienza della sorgente · source efficiency
10	codice sorgente elettronica Viabizzuno · Viabizzuno led source code
11	superficie emittente · light emitting surface (mm)
12	% flusso residuo a fine vita · end life % flux
13	% consentita sotto limite · allowed % under limit









gradi di protezione protection degrees

IPOX	non protetto no protection
IP1X	contro corpi estranei >50 mm protection against solid objects
IP2X	contro corpi estranei >12 mm protection against solid objects
IP3X	contro corpi estranei >2,5 mm protection against solid objects
IP4X	contro corpi estranei >1 mm protection against solid objects
IP5X	protezione da polvere dust-protected
IP6X	stagno alla polvere dust-proof

IPX0	non protetto no protection
IPX1	protetto contro la caduta verticale di gocce d'acqua protected against water drops falling vertically
IPX2	protetto contro la caduta di gocce con inclinazione max 15° protected against water drops max inclination 15°
IPX3	protetto contro la caduta di gocce con inclinazione max 60° protected against water drops max inclination 60°
IPX4	protetto contro spruzzi d'acqua protected against sprinkling water
IPX5	protetto contro getti d'acqua protected against water jets
IPX6	protetto contro inondazioni protected against flooding
IPX7	per breve immersione protected against brief immersions
IPX8	per immersione prolungata protected against long immersion

IK01	nessuna protezione no protection
IK01	protetto contro l'energia d'urto 0,15J protected against collision energy
IK02	protetto contro l'energia d'urto 0,2J protected against collision energy
IK03	protetto contro l'energia d'urto 0,35J protected against collision energy
IK04	protetto contro l'energia d'urto 0,5J protected against collision energy
IK05	protetto contro l'energia d'urto 0,7J protected against collision energy
IK06	protetto contro l'energia d'urto 1J protected against collision energy
IK07	protetto contro l'energia d'urto 2J protected against collision energy
IK08	protetto contro l'energia d'urto 5J protected against collision energy
IK09	protetto contro l'energia d'urto 10J protected against collision energy
IK10	protetto contro l'energia d'urto 20J protected against collision energy

legenda simboli symbols key

ta	<i>tavolo</i> · table
tr	<i>terra</i> · floor standing
s	<i>soffitto</i> · ceiling
p	<i>parete</i> · wall
sp	<i>sospensione</i> · suspension
bin	<i>binario</i> · track
in	<i>incasso</i> · recessed
st	<i>scomparsa totale</i> · fully concealed
s+e	<i>segnaletica+emergenza</i> · signalling system+emergency
bat	<i>portatili autoalimentati a batteria</i> · portable self-powered with battery
sis	<i>sistemi</i> · systems
pa	<i>palo</i> · pole
pt	<i>palletto</i> · bollard
sd	<i>seduta</i> · sitting
V	<i>disponibile su</i> · available on <i>Viabizzuno applight</i> <i>www.Viabizzuno.com</i> <i>Viabizzuno online</i>
	<i>classe I. solo isolamento fondamentale, le parti conduttrici accessibili sono collegate ad un conduttore di terra. messa a terra tassativa</i> class I. only basic insulation, accessible conductors are earthed. earthing compulsory
	<i>classe II. all'isolamento principale è aggiunto un secondo isolamento oppure ai due isolamenti è sostituito un isolamento rinforzato. messa a terra esclusa</i> class II. basic insulation plus second insulation or both are replaced by reinforced insulation. earthing excluded
	<i>classe III. alimentazione effettuata con bassissima tensione di sicurezza; sono escluse tensioni superiori a 50V-50Hz. messa a terra non prevista.</i> class III. very low safety supply tension; not to be used over 50V-50Hz. earthing excluded.
CE	<i>prodotto conforme alle direttive europee</i> · produced in compliance with ec directives
	<i>marchio di certificazione europea. certifica che il prodotto è conforme alle norme europee sulla sicurezza</i> component approved for north american market and suitable to be used and approved as part of a more complex system
cULus	<i>componente certificato per il mercato nord americano idoneo ad essere utilizzato e valutato come parte di in un sistema più complesso</i> component approved for north american market and suitable to be used and approved as part of a more complex system
KEMA KEUR	<i>apparecchio di illuminazione approvato da kema</i> · kema approved light fitting
WRAS 	<i>prodotto conforme agli standard presenti nel regno unito che regolamentano la sicurezza e la qualità dell'acqua</i> · product complies with uk standards set out by water regulations
	<i>apparecchio di illuminazione certificato secondo le normative vigenti in polonia che regolamentano i dispositivi di sicurezza antincendio</i> certified light fitting according to the regulations about devices for fire safety in force in poland
	<i>prodotto idoneo per essere commercializzato nel mercato cinese</i> · product suitable for the china market
	<i>prodotto finito idoneo per essere commercializzato nel mercato nord americano</i> · listed product suitable for the north american market
UK CA	<i>prodotto conforme alla legislazione vigente nel regno unito</i> · produced in compliance with UK legislation
	<i>apparecchio di illuminazione certificato per il mercato cinese</i> light fitting certified for china market

	<i>vetro opalino</i> · opal glass
	<i>vetro sabbiato</i> · sanded glass
	<i>vetro nero fumè</i> · black smoke glass
	<i>vetro trasparente</i> · transparent glass
	<i>vetro bianco latte</i> · white milk glass
	<i>cristallo</i> · crystal
	<i>policarbonato opalino</i> · opal polycarbonate diffuser
	<i>carrabile</i> · drive over
A	<i>alimentatore incluso</i> · power supply included
	<i>alimentatore escluso</i> · power supply not included
AR	<i>alimentatore remoto incluso</i> · remote power supply included
Ai	<i>alimentatore elettronico con controllo intelligente incluso</i> · electronic power supply with smart control included
AiR	<i>alimentatore elettronico con controllo intelligente incluso, da installare remoto</i> · electonic power supply with smart control included, to be installed remotely
AS	<i>alimentatore a spina incluso</i> · plug power supply included
T	<i>trasformatore incluso</i> · transformer included
	<i>trasformatore escluso</i> · transformer not included
K	<i>kit di cablaggio</i> · wiring kit
	<i>kit di cablaggio escluso</i> · wiring kit not included
L	<i>lampadina con sorgente elettronica led, ad incandescenza, alogena o fluorescente inclusa.</i> bulb with led electronic source, incandescent, halogen or fluoresecent included.
	<i>lampadina con sorgente elettronica led, ad incandescenza, alogena o fluorescente esclusa.</i> bulb with led electronic source, incandescent, halogen or fluoresecent not included.
Pr	<i>propulsore dinamico n55 incluso</i> · included
	<i>propulsore dinamico n55 escluso</i> · not included
df	<i>diffusore incluso</i> · diffuser included
	<i>diffusore escluso</i> · diffuser not included
	<i>possibilità di combinazione tra interfaccia n55, propulsore dinamico n55 e lampadina n55</i> · possible combination between n55 interface, propulsore dinamico n55 and n55 bulb
	<i>attenzione: sorgente luminosa led. non guardare mai direttamente a occhio nudo</i> · attention: led light source. never look straight without eye protection
ff	<i>flicker free compatibile con fotocamere digitali</i> · flicker free digital camera friendly
l.d.	<i>luce diretta</i> · direct light
l.i.	<i>luce indiretta</i> · indirect light
.d1	<i>dimmerazione 1-10V</i> · 1-10V dimmable
.d2	<i>dimmerazione dali</i> · dimmable dali
.SA	<i>kit luce + emergenza sempre accese. attenzione: non è possibile installare nelle cassaforme laterizio</i> light kit + permanently lit emergency lamp. please note: cannot be installed in brickwork housing
.SE	<i>solo emergenza sempre accesa. attenzione: non è possibile installare nelle cassaforme laterizio</i> permanently lit emergency lamp only. please note: cannot be installed in brickwork housing
i	<i>peso netto</i> · net weight (kg)