



*Viabizzuno strada principale della frazione di bizzuno in provincia di ravenna dove tra la casa del popolo e la parrocchia, al n°17, sono nato il ventuno luglio millenovecentocinquantacinque. da qui nasce il nome della fabbrica di produzione fondata nel millenovecentonovantaquattro rappresentata da uno spazio bianco attraversato da due linee. una verticale, rigorosa, essenziale, equilibrata: la luce per la luce; ed una inclinata, irriverente nello spazio, ironica, fuori dagli schemi: la luce per la forma. distinte ma complementari si fondono in un unico nome: Viabizzuno.*

*marionanni*

Viabizzuno is the name of the main road of the small village bizzuno located in the province of ravenna, where I was born on the twenty-first july nineteenfiftyfive at n°17, between the 'casa del popolo' and the local parish church. from here the name of the factory founded in nineteen ninety-four represented by a white space intersected by two lines. one vertical, well balanced, logical, essential: the light for the light. the other one dynamic, irreverent, ironic: the light for the form. separate and yet complementary they cast in the same name: Viabizzuno.

prodotto  
product



schede tecniche  
technical data sheet



curve fotometriche  
photometric curves



modelli 3d per i tuoi render  
3d models for your render





**apparecchio di illuminazione a scomparsa totale per interni IP20.**  
 realizzato in alluminio ossidato e verniciato a polvere, con cassaforme in cartongesso rettangolare a scomparsa totale di dimensioni 288x124mm e 528x124mm, predisposte per alloggiare kit con sorgenti elettroniche per luce d'accento.  
**modelli:**  
 net 24 scomparsa totale spot 20° per luce d'accento 19,2W fino a 1626lm,  
 net 24 scomparsa totale con vetro sabbato di protezione per luce diffusa fino a 16,9W 1380lm,  
 net 48 scomparsa totale spot 20° per luce d'accento 38,2W fino a 3252lm,  
 net 48 scomparsa totale con vetro sabbato di protezione per luce diffusa fino a 33,8W 2760lm.  
 i modelli spot 20° sono orientabili fino a 355° sull'asse verticale e di 20° sull'asse orizzontale e di anello antiabbagliamento per garantire comfort visivo.  
 cablato con sorgente elettronica 2700K o 3000K.  
 alimentatore in corrente costante escluso, da installare remoto.  
 finiture: bianco V, argento hacca e marrone mn.

**IP20 rated fully concealed light fitting for indoor use.**  
 made of oxidised and powder coated aluminium with a fully concealed plasterboard rectangular housings measuring 288x124mm and 528x124mm, designed to accommodate led source kits for accent light.  
**versions:**  
 net 24 scomparsa totale spot 20° with spot light 19.2W up to 1626lm,  
 net 24 scomparsa totale with protective sanded glass for diffuse light up to 16.9W 1380lm,  
 net 48 scomparsa totale 20° with spot light 38.2W up to 3252lm,  
 net 48 scomparsa totale with protective sanded glass for diffuse light up to 33.8W 2760lm.  
 20° spotlight versions are adjustable by 355° on the vertical axis and by 20° on the horizontal axis and are provided with an anti-glare ring ensuring high visual comfort.  
 wired with 2700K or 3000K led source.  
 constant current power supply not included, to be installed remotely.  
 finishes: bianco V, argento hacca and marrone mn.

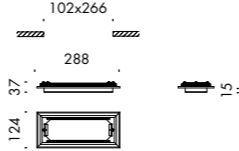

net 24 scomparsa totale		☑	★	CE	i
<b>Vb6.592.81</b>	cornice scomparsa totale fully concealed frame	bianco V			1
<b>Vb6.592.82</b>	cornice scomparsa totale fully concealed frame	argento hacca			1
<b>Vb6.592.83</b>	cornice scomparsa totale fully concealed frame	marrone mn			1

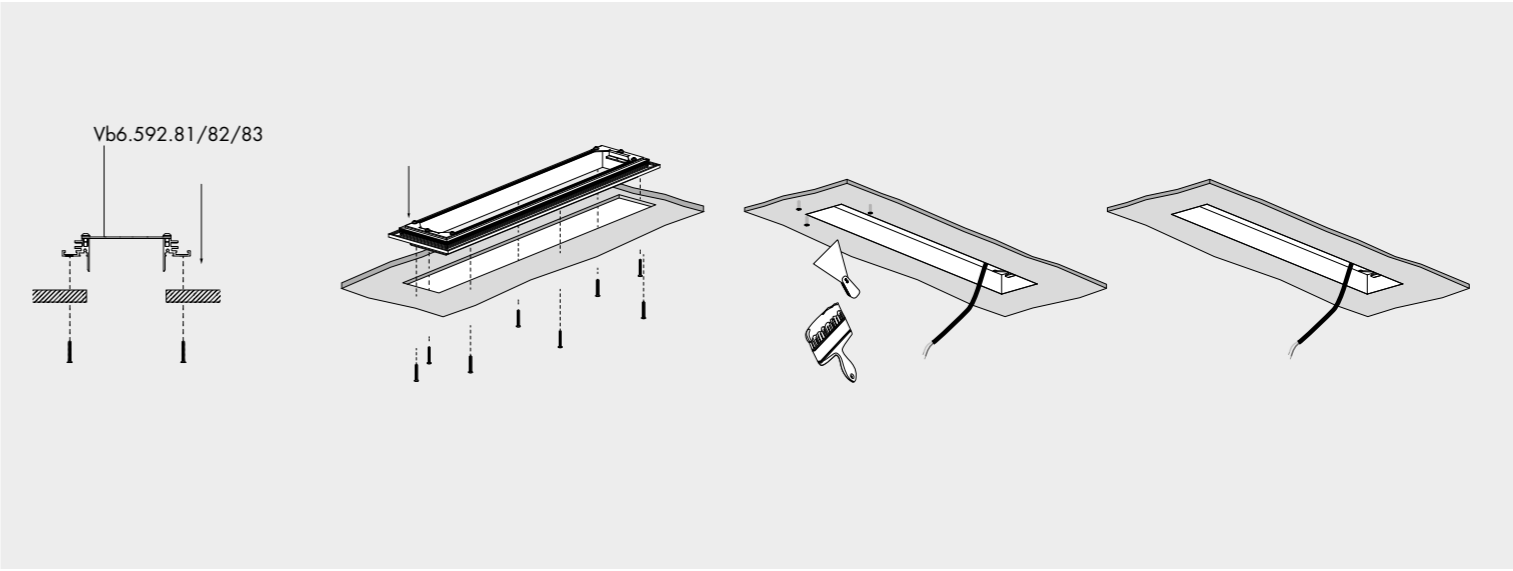

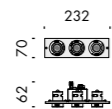

**kit net 24 scomparsa totale spot**

<b>Vb6.592.01.27</b>	bianco V	2700K	20°	3x6,4W	1,1
<b>Vb6.592.02.27</b>	argento hacca	2700K	20°	3x6,4W	1,1
<b>Vb6.592.03.27</b>	marrone mn	2700K	20°	3x6,4W	1,1

Ra	R9	ies tm-30		sdc	mA	V <sub>f</sub> (min)	lm	W	lm/W
98	95	Rf 95	Rg 100	step 2	700	9,1	1512	19,2	78
cd0223	les6	Ta25 °C		vita media · average life		50000 h	L80	B10	

<b>Vb6.592.01.30</b>	bianco V	3000K	20°	3x6,4W	1,1
<b>Vb6.592.02.30</b>	argento hacca	3000K	20°	3x6,4W	1,1
<b>Vb6.592.03.30</b>	marrone mn	3000K	20°	3x6,4W	1,1

Ra	R9	ies tm-30		sdc	mA	V <sub>f</sub> (min)	lm	W	lm/W
98	95	Rf 95	Rg 100	step 2	700	9,1	1626	19,2	85
cd0233	les6	Ta25 °C		vita media · average life		50000 h	L80	B10	

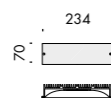

**kit net 24 led scomparsa totale diffusa**

<b>Vb6.592.04.27</b>		2700K	luce diffusa diffused light	1
----------------------	--	-------	--------------------------------	---

Ra	R9	ies tm-30		sdc	mA	V <sub>f</sub> (min)	lm	W	lm/W
97	90	Rf 96	Rg 100	step 2	500	23,7	877	11,9	74
					700	24,2	1208	16,9	71
dz010	10	Ta25 °C		vita media · average life		50000 h	L80	B10	

<b>Vb6.592.04.30</b>		3000K	luce diffusa diffused light	1
----------------------	--	-------	--------------------------------	---

Ra	R9	ies tm-30		sdc	mA	V <sub>f</sub> (min)	lm	W	lm/W
97	90	Rf 96	Rg 100	step 2	500	23,7	1002	11,9	84
					700	24,2	1380	16,9	82
dz011	10	Ta25 °C		vita media · average life		50000 h	L80	B10	



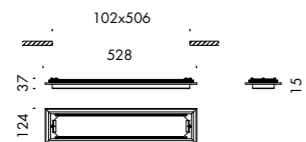

**net 48 scomparsa totale**

<b>Vb6.592.86</b>	cornice scomparsa totale fully concealed frame	bianco V	1,5
<b>Vb6.592.87</b>	cornice scomparsa totale trimless frame	argento hacca	1,5
<b>Vb6.592.88</b>	cornice scomparsa totale trimless frame	marrone mn	1,5

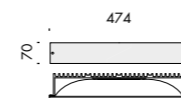

**kit net 48 scomparsa totale spot**

<b>Vb6.592.11.27</b>	bianco V	2700K	20°	6x6,4W	2
<b>Vb6.592.12.27</b>	argento hacca	2700K	20°	6x6,4W	2
<b>Vb6.592.13.27</b>	marrone mn	2700K	20°	6x6,4W	2

Ra	R9	ies tm-30		sdcm	mA	V <sub>f(min)</sub>	lm	W	lm/W
98	95	Rf 95	Rg 100	step 2	1400	27,3	3252	38,2	85,1
cd022-6	les6	Ta25 °C		vita media · average life		50000 h		L80 B10	

<b>Vb6.592.11.30</b>	bianco V	3000K	20°	6x6,4W	2
<b>Vb6.592.12.30</b>	argento hacca	3000K	20°	6x6,4W	2
<b>Vb6.592.13.30</b>	marrone mn	3000K	20°	6x6,4W	2

Ra	R9	ies tm-30		sdcm	mA	V <sub>f(min)</sub>	lm	W	lm/W
98	95	Rf 95	Rg 100	step 2	1400	27,3	3252	38,2	85,1
cd023-6	les6	Ta25 °C		vita media · average life		50000 h		L80 B10	

**kit net 48 scomparsa totale diffusa**

<b>Vb6.592.14.27</b>	2700K	luce diffusa · diffused light	2
----------------------	-------	-------------------------------	---

Ra	R9	ies tm-30		sdcm	mA	V <sub>f(min)</sub>	lm	W	lm/W
97	90	Rf 96	Rg 100	step 2	500	47,4	1754	23,8	74
					700	48,4	2416	33,8	71
dz010-2	10	Ta25 °C		vita media · average life		50000 h		L80 B10	

<b>Vb6.592.14.30</b>	3000K	luce diffusa · diffused light	2
----------------------	-------	-------------------------------	---

Ra	R9	ies tm-30		sdcm	mA	V <sub>f(min)</sub>	lm	W	lm/W
97	90	Rf 96	Rg 100	step 2	500	47,4	2004	23,8	84
					700	48,4	2760	33,8	82
dz011-2	10	Ta25 °C		vita media · average life		50000 h		L80 B10	



**lettura delle tabelle tecniche how to read technical tables**

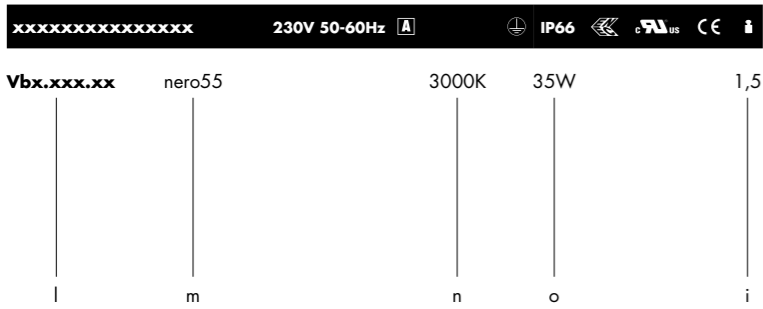
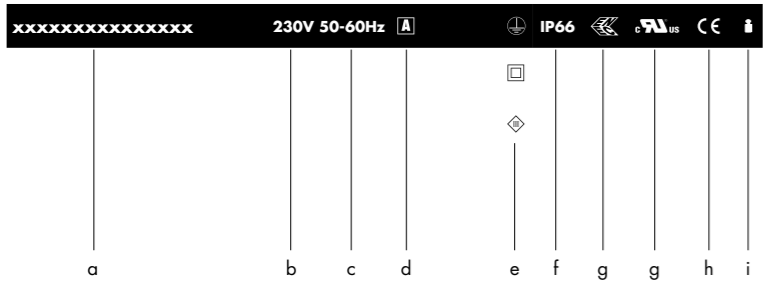

**componenti. components.** IK10 CE

**accessori. accessories.** IK10 CE

1	2	3	4	5	6	7	8	9	
Ra	R9	ies tm-30		sdcm	mA	V <sub>f (min)</sub>	lm	W	lm/W
98	98	Rf 96	Rg 103	step 1	350	27,6	1240	9,7	128
					500	27,9	1580	14,0	113
xm000	les19	Ta25 °C		vita media · average life		70000 h	L80	B10	
10	11						12	13	

bandella tecnica. posizioni standard simbologie.  
data plate. standard arrangement of symbols.

a	nome apparecchio di illuminazione · light fitting name
b	tensione di alimentazione · supply rating (Volt)
c	frequenza di alimentazione · supply frequency (Hertz)
d	alimentatore incluso o escluso · power supply included or not included
e	classe di isolamento · insulation class
f	grado di protezione · protection degree
g	marchio di certificazione · safety and quality standards certification
h	conforme alle direttive europee produced in compliance with EC directives
i	peso netto · net weight (kg)
l	codice · code
m	finitura · finish
n	temperatura colore sorgente elettronica colour temperature led source (Kelvin)
o	potenza della sorgente · source power (Watt)

componenti. identifica tutti gli elementi indispensabili per la corretta funzionalità e installazione dell'apparecchio di illuminazione.  
components. includes all items that are essential to the correct operation and installation of the light fitting.

accessori. si riferisce alle ulteriori parti installabili sull'apparecchio.  
accessories. refers to items that can be added to the light fitting.

1	indice di resa cromatica · colour rendering index
2	indice di resa del rosso · red colour rendering index
3	Rf indice di fedeltà colore · colour fidelity index Rg indice di saturazione colore · color gamut index
4	step di macadam · macadam step
5	corrente di alimentazione · power supply current
6	tensione di alimentazione · power supply voltage
7	flusso luminoso · light flux
8	potenza della sorgente · source power
9	efficienza della sorgente · source efficiency
10	codice sorgente elettronica Viabizzuno · Viabizzuno led source code
11	superficie emittente · light emitting surface (mm)
12	% flusso residuo a fine vita · end life % flux
13	% consentita sotto limite · allowed % under limit

**gradi di protezione protection degrees**

IPX0	non protetto no protection	IK01	nessuna protezione no protection
IPX1	protetto contro la caduta verticale di gocce d'acqua protected against water drops falling vertically	IK01	protetto contro l'energia d'urto 0,15J protected against collision energy
IPX2	protetto contro la caduta di gocce con inclinazione max 15° protected against water drops max inclination 15°	IK02	protetto contro l'energia d'urto 0,2J protected against collision energy
IPX3	protetto contro la caduta di gocce con inclinazione max 60° protected against water drops max inclination 60°	IK03	protetto contro l'energia d'urto 0,35J protected against collision energy
IPX4	protetto contro spruzzi d'acqua protected against sprinkling water	IK04	protetto contro l'energia d'urto 0,5J protected against collision energy
IPX5	protetto contro getti d'acqua protected against water jets	IK05	protetto contro l'energia d'urto 0,7J protected against collision energy
IPX6	protetto contro inondazioni protected against flooding	IK06	protetto contro l'energia d'urto 1J protected against collision energy
IPX7	per breve immersione protected against brief immersions	IK07	protetto contro l'energia d'urto 2J protected against collision energy
IPX8	per immersione prolungata protected against long immersion	IK08	protetto contro l'energia d'urto 5J protected against collision energy
IPX9	per immersione prolungata protected against long immersion	IK09	protetto contro l'energia d'urto 10J protected against collision energy
IPX10	per immersione prolungata protected against long immersion	IK10	protetto contro l'energia d'urto 20J protected against collision energy

IPOX	non protetto no protection
IP1X	contro corpi estranei >50 mm protection against solid objects
IP2X	contro corpi estranei >12 mm protection against solid objects
IP3X	contro corpi estranei >2,5 mm protection against solid objects
IP4X	contro corpi estranei >1 mm protection against solid objects
IP5X	protezione da polvere dust-protected
IP6X	stagno alla polvere dust-proof

## legenda simboli symbols key

<b>ta</b>	<i>tavolo</i> · table
<b>tr</b>	<i>terra</i> · floor standing
<b>s</b>	<i>soffitto</i> · ceiling
<b>p</b>	<i>parete</i> · wall
<b>sp</b>	<i>sospensione</i> · suspension
<b>bin</b>	<i>binario</i> · track
<b>in</b>	<i>incasso</i> · recessed
<b>st</b>	<i>scomparsa totale</i> · fully concealed
<b>s+e</b>	<i>segnaletica+emergenza</i> · signalling system+emergency
<b>bat</b>	<i>portatili autoalimentati a batteria</i> · portable self-powered with battery
<b>sis</b>	<i>sistemi</i> · systems
<b>pa</b>	<i>palo</i> · pole
<b>pt</b>	<i>paletto</i> · bollard
<b>sd</b>	<i>seduta</i> · sitting
<b>V</b>	<i>disponibile su</i> · available on <i>Viabizzuno applight</i> <i>www.Viabizzuno.com</i> <i>Viabizzuno online</i>
	<i>classe I. solo isolamento fondamentale, le parti conduttrici accessibili sono collegate ad un conduttore di terra. messa a terra tassativa</i> class I. only basic insulation, accessible conductors are earthed. earthing compulsory
	<i>classe II. all'isolamento principale è aggiunto un secondo isolamento oppure ai due isolamenti è sostituito un isolamento rinforzato. messa a terra esclusa</i> class II. basic insulation plus second insulation or both are replaced by reinforced insulation. earthing excluded
	<i>classe III. alimentazione effettuata con bassissima tensione di sicurezza; sono escluse tensioni superiori a 50V-50Hz. messa a terra non prevista.</i> class III. very low safety supply tension; not to be used over 50V-50Hz. earthing excluded.
	<i>prodotto conforme alle direttive europee</i> · produced in compliance with ec directives
	<i>marchio di certificazione europea. certifica che il prodotto è conforme alle norme europee sulla sicurezza</i> component approved for north american market and suitable to be used and approved as part of a more complex system
	<i>componente certificato per il mercato nord americano idoneo ad essere utilizzato e valutato come parte di in un sistema più complesso</i> component approved for north american market and suitable to be used and approved as part of a more complex system
	<i>apparecchio di illuminazione approvato da kema</i> · kema approved light fitting
	<i>prodotto conforme agli standard presenti nel regno unito che regolamentano la sicurezza e la qualità dell'acqua</i> · product complies with uk standards set out by water regulations
	<i>apparecchio di illuminazione certificato secondo le normative vigenti in polonia che regolamentano i dispositivi di sicurezza antincendio</i> certified light fitting according to the regulations about devices for fire safety in force in poland
	<i>prodotto idoneo per essere commercializzato nel mercato cinese</i> · product suitable for the china market
	<i>prodotto finito idoneo per essere commercializzato nel mercato nord americano</i> · listed product suitable for the north american market
	<i>prodotto conforme alla legislazione vigente nel regno unito</i> · produced in compliance with UK legislation
	<i>apparecchio di illuminazione certificato per il mercato cinese</i> light fitting certified for china market

	<i>vetro opalino</i> · opal glass
	<i>vetro sabbiato</i> · sanded glass
	<i>vetro nero fumè</i> · black smoke glass
	<i>vetro trasparente</i> · transparent glass
	<i>vetro bianco latte</i> · white milk glass
	<i>crystallo</i> · crystal
	<i>policarbonato opalino</i> · opal polycarbonate diffuser
	<i>carrabile</i> · drive over
	<i>alimentatore incluso</i> · power supply included
	<i>alimentatore escluso</i> · power supply not included
	<i>alimentatore remoto incluso</i> · remote power supply included
	<i>alimentatore elettronico con controllo intelligente incluso</i> · electronic power supply with smart control included
	<i>alimentatore elettronico con controllo intelligente incluso, da installare remoto</i> · electronic power supply with smart control included, to be installed remotely
	<i>alimentatore a spina incluso</i> · plug power supply included
	<i>trasformatore incluso</i> · transformer included
	<i>trasformatore escluso</i> · transformer not included
	<i>kit di cablaggio</i> · wiring kit
	<i>kit di cablaggio escluso</i> · wiring kit not included
	<i>lampadina con sorgente elettronica led, ad incandescenza, alogena o fluorescente inclusa.</i> bulb with led electronic source, incandescent, halogen or fluorescent included.
	<i>lampadina con sorgente elettronica led, ad incandescenza, alogena o fluorescente esclusa.</i> bulb with led electronic source, incandescent, halogen or fluorescent not included.
	<i>propulsore dinamico n55 incluso</i> · included
	<i>possibilità di combinazione tra interfaccia n55, propulsore dinamico n55 e lampadina n55</i> · possible combination between n55 interface, propulsore dinamico n55 and n55 bulb
	<i>attenzione: sorgente luminosa led. non guardare mai direttamente a occhio nudo</i> · attention: led light source. never look straight without eye protection
	<i>flicker free compatibile con fotocamere digitali</i> · flicker free digital camera friendly
<b>l.d.</b>	<i>luce diretta</i> · direct light
<b>l.i.</b>	<i>luce indiretta</i> · indirect light
<b>.d1</b>	<i>dimmerazione 1-10V</i> · 1-10V dimmable
<b>.d2</b>	<i>dimmerazione dali</i> · dimmable dali
<b>.SA</b>	<i>kit luce + emergenza sempre accese. attenzione: non è possibile installare nelle cassaforme laterizio</i> light kit + permanently lit emergency lamp. please note: cannot be installed in brickwork housing
<b>.SE</b>	<i>solo emergenza sempre accesa. attenzione: non è possibile installare nelle cassaforme laterizio</i> permanently lit emergency lamp only. please note: cannot be installed in brickwork housing
	<i>peso netto</i> · net weight (kg)