



Viabizzuno strada principale della frazione di bizzuno in provincia di ravenna dove tra la casa del popolo e la parrocchia, al n°17, sono nato il ventuno luglio millenovecentocinquantacinque. da qui nasce il nome della fabbrica di produzione fondata nel millenovecentonovantaquattro rappresentata da uno spazio bianco attraversato da due linee. una verticale, rigorosa, essenziale, equilibrata: la luce per la luce; ed una inclinata, irriverente nello spazio, ironica, fuori dagli schemi: la luce per la forma. distinte ma complementari si fondono in un unico nome: Viabizzuno.

marionanni

Viabizzuno is the name of the main road of the small village bizzuno located in the province of ravenna, where I was born on the twenty-first july nineteenfiftyfive at n°17, between the 'casa del popolo' and the local parish church. from here the name of the factory founded in nineteen ninety-four represented by a white space intersected by two lines. one vertical, well balanced, logical, essential: the light for the light. the other one dynamic, irreverent, ironic: the light for the form. separate and yet complementary they cast in the same name: Viabizzuno.

prodotto
product



schede tecniche
technical data sheet



curve fotometriche
photometric curves



modelli 3d per i tuoi render
3d models for your render





sistema modulare per interni IP54 realizzato in ottone naturale e acciaio studiato per la distribuzione di linee di alimentazione e dati con sistema di illuminazione modulare, completamente integrato nella pavimentazione e ispezionabile.
modelli:
 ticablo, cassaforma scomparsa totale Ø330 con coperchio Ø160 predisposto per alloggiamento cablaggio ed elettronica di alimentazione e boccola ad innesto rapido;
 ticablo singola centrale, cassaforma scomparsa totale Ø290 con coperchio Ø160 predisposto per alloggiamento cablaggio ed elettronica di alimentazione;
 ticablo perimetrale singola e tripla boccola ad innesto rapido;
 ticablo asta, interfaccia sistema n55 h. 2100mm, cablato con propulsore dinamico n55 les19 3000K 19,9W 700mA 2140lm Ra98 1 step macadam. l'apposito attacco n55 permette di intercambiare tre tipi di diffusori: classico, decorativo e tecnico.
 accessori: moduli a terra e a parete predisposti per serie arkè vimar due moduli parete o terra
 finiture: argento hacca, ottone naturale, nero, rosso

IP54 indoor modular system made of natural brass and steel designed for distribution of power and data lines with modular lighting system, fully integrated into the floor and inspectable.
versions:
 ticablo, full retractable formwork Ø330 with cover Ø160 arranged for housing wiring and power electronics and quick-connect bushing;
 ticablo singola centrale, full retractable formwork Ø290 with cover Ø160 arranged for housing wiring and power electronics;
 ticablo perimetrale singole e tripla quick-connect bushing;
 ticablo asta, n55 interface system h. 2100mm, wired with n55 dynamic thruster les19 3000K 19,9W 700mA 2140lm Ra98 1 step macadam
 the specific n55 lamp-holder allows to change three types of light diffuser: classic, decorative and technical
 accessories: ground and wall modules arranged for arkè vimar series two modules
 finishes: argento hacca, natural brass, black, red

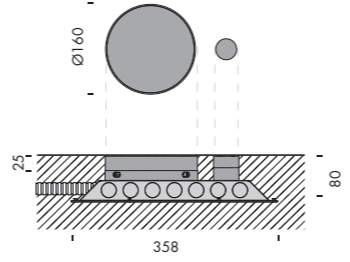

ticablo ⊕ ☆ CE i

Vb9.675.001 ottone naturale · natural brass
 rosso · red 1,2

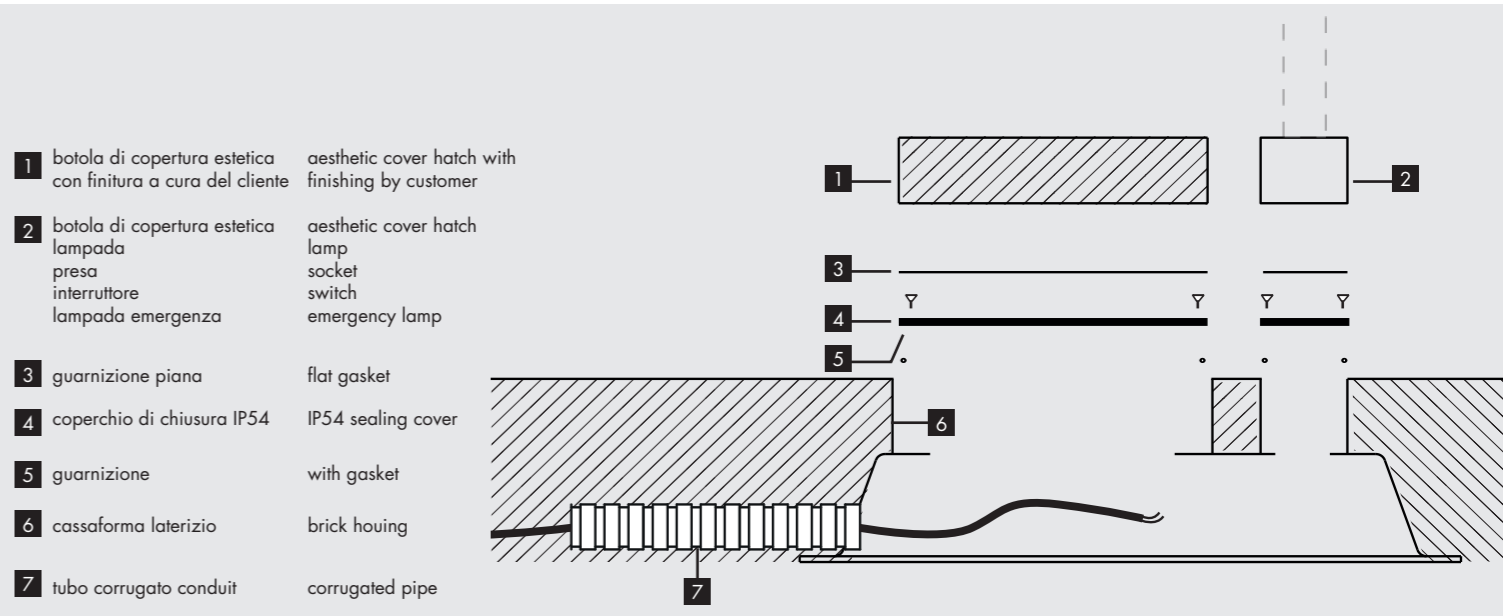

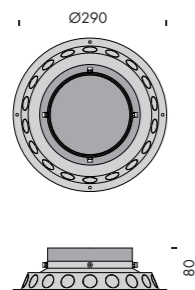

ticablo singola centrale







Vb9.675.002

ottone naturale · natural brass
rosso · red

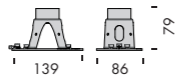



1,2



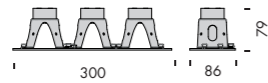

ticablo singola perimetrale    
Vb9.675.003 ottone naturale · natural brass 1,2
rosso · red



ticablo tripla perimetrale    
Vb9.675.004 ottone naturale · natural brass 1,2
rosso · red



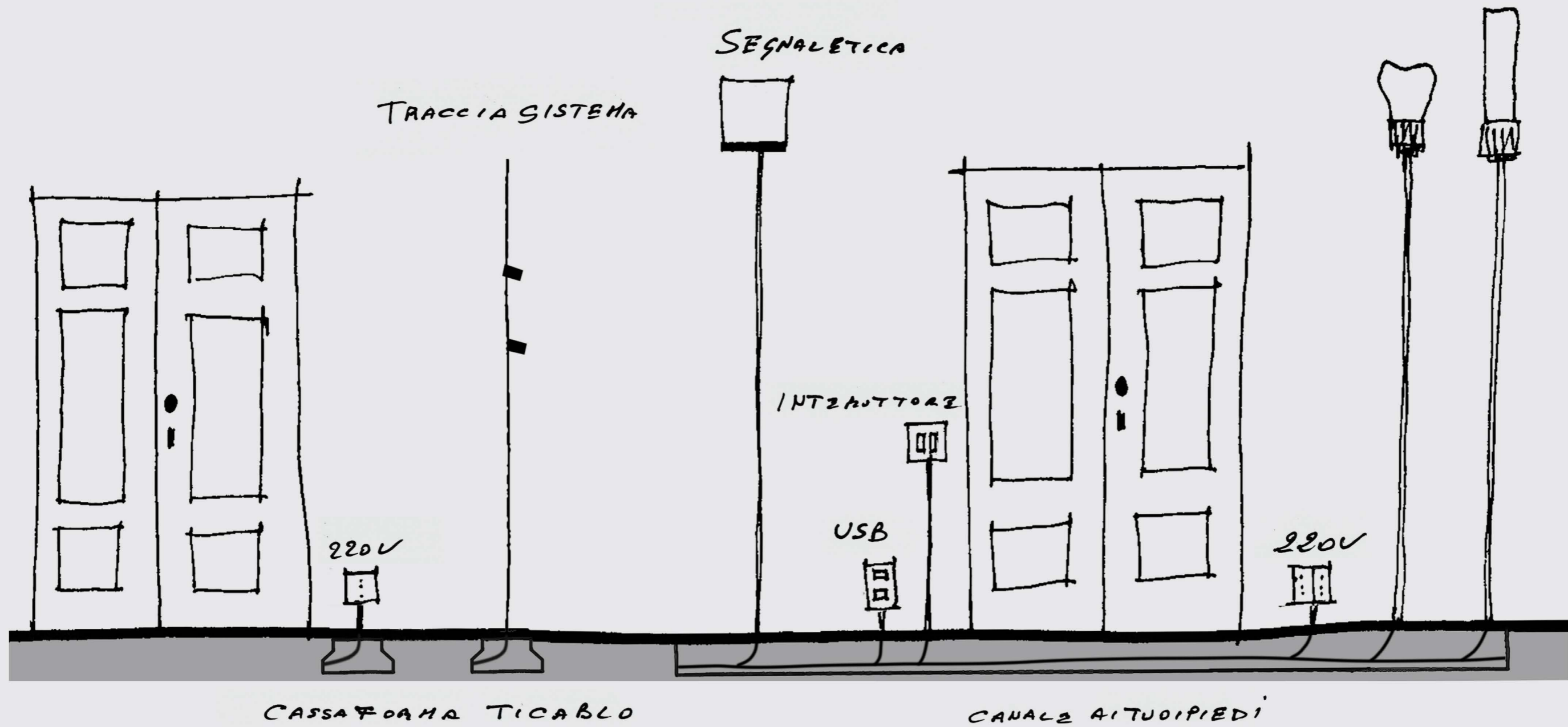

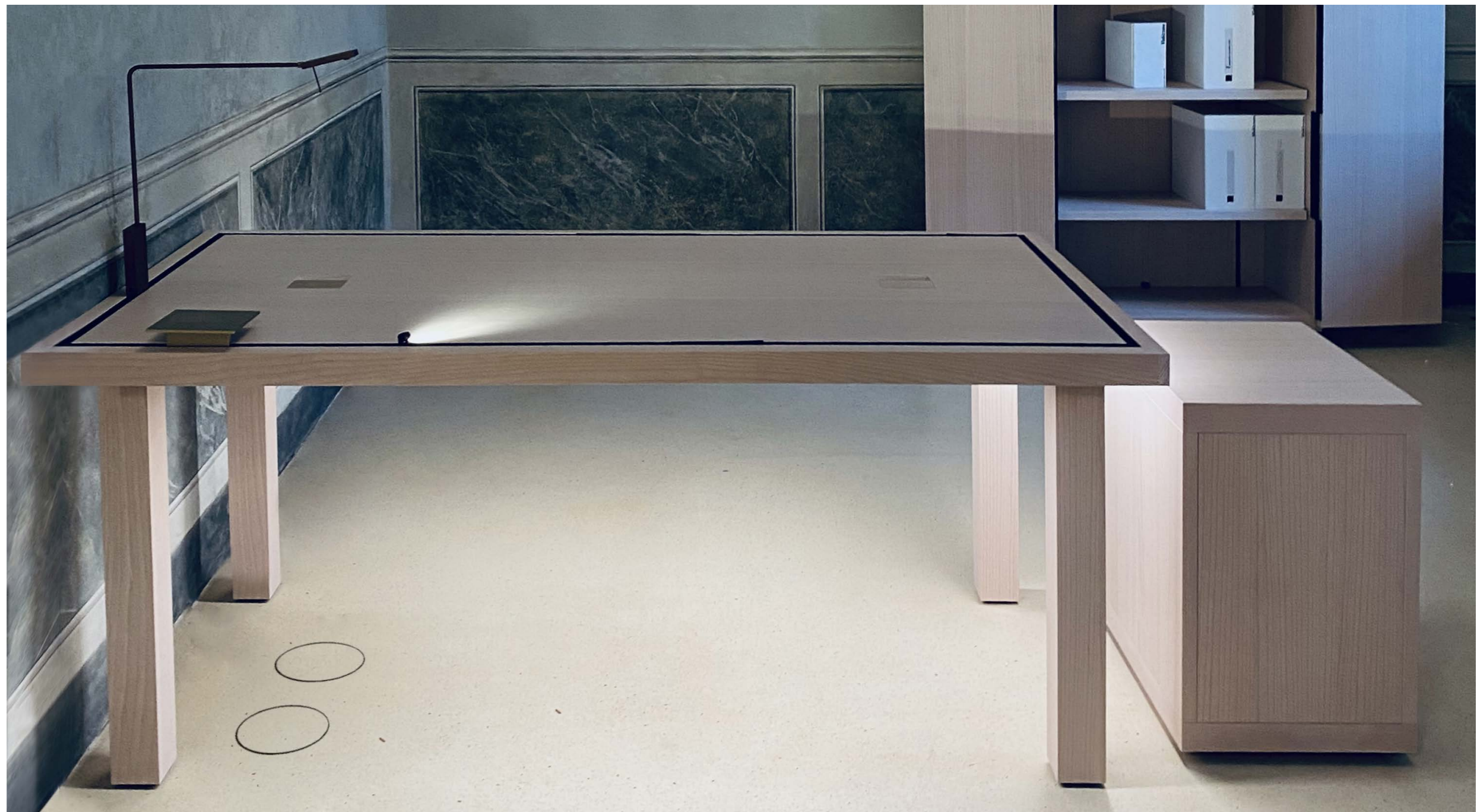

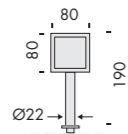
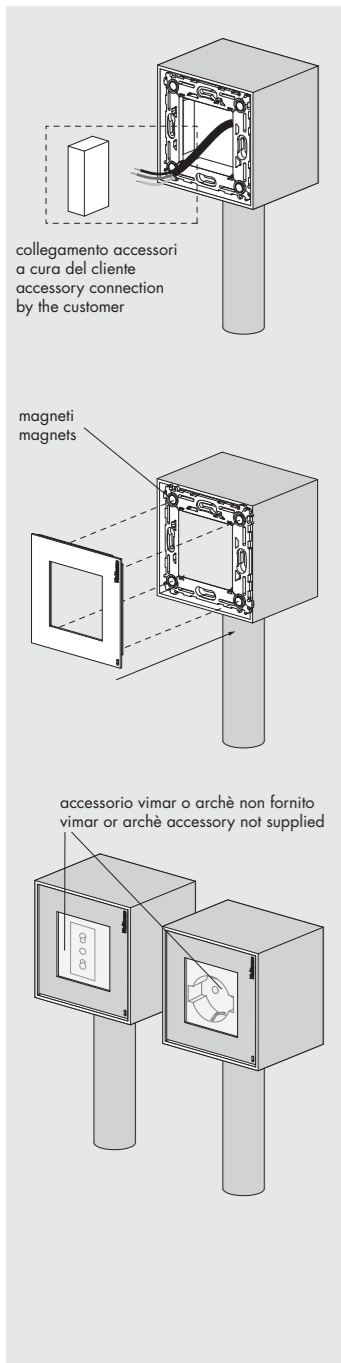

modulo 1		CE	i
Vb4.675.101	ottone naturale · natural brass		1,5
Vb4.675.103	argento hacca		1,5
Vb4.675.102	nero55		1,5



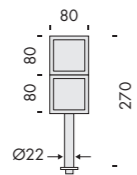
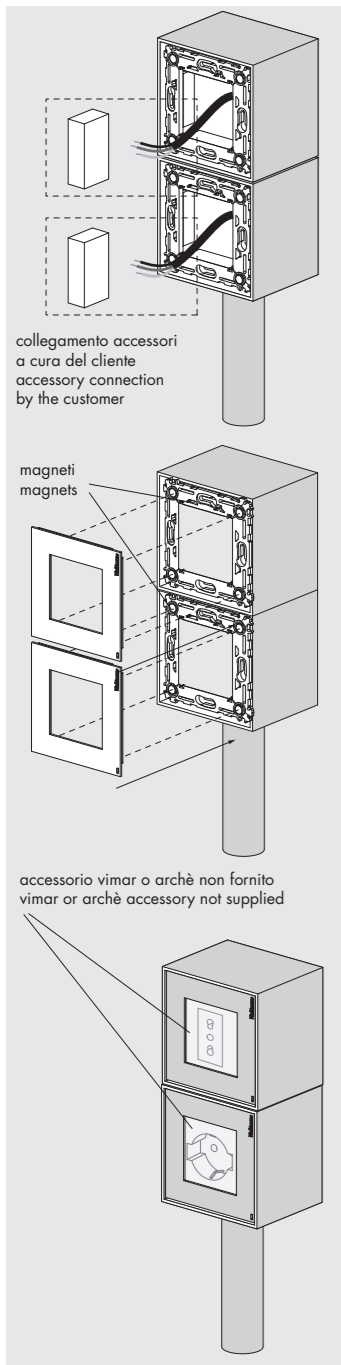

modulo 2		CE	i
Vb4.675.104	ottone naturale · natural brass		1,5
Vb4.675.106	argento hacca		1,5
Vb4.675.105	nero55		1,5



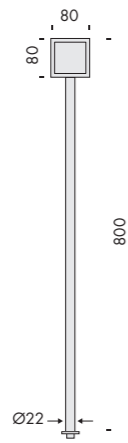
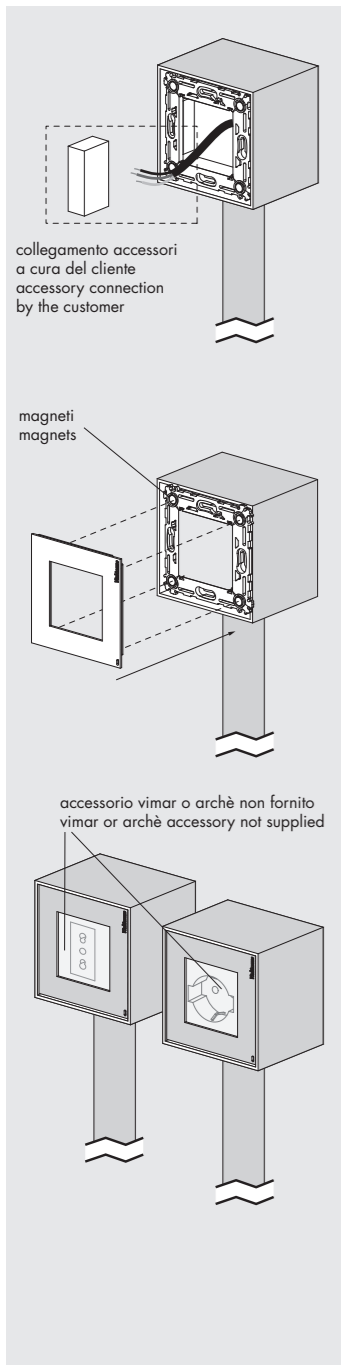

modulo 2 terra		CE	i
Vb4.675.107	ottone naturale · natural brass		1,5
Vb4.675.109	argento hacca		1,5
Vb4.675.108	nero55		1,5



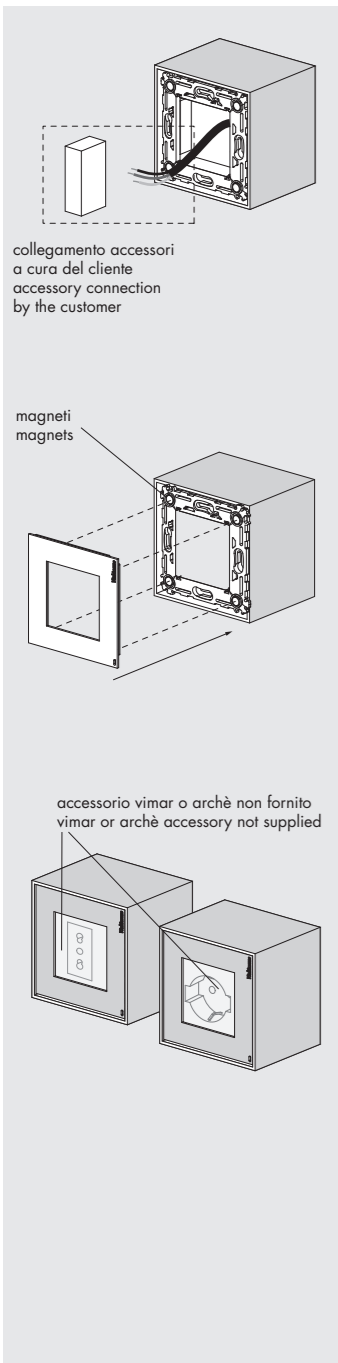

modulo a parete singolo. single wall module.		€	h
Vb5.675.201	ottone naturale · natural brass	1,5	
Vb5.675.203	argento hacca	1,5	
Vb5.675.202	nero55	1,5	

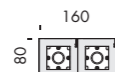

modulo a parete doppio. double wall module.		€	h
Vb5.675.204	ottone naturale · natural brass	1,5	
Vb5.675.206	argento hacca	1,5	
Vb5.675.205	nero55	1,5	



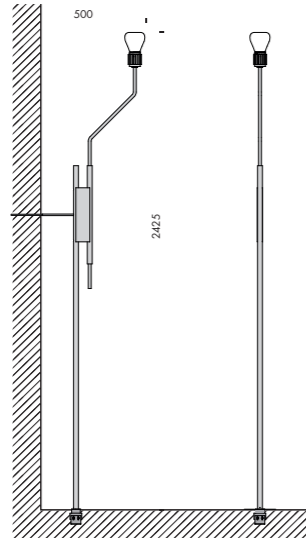

lancillotto terra parete hm02 220-240V 50-60Hz

- Vb4.673.004** argento hacca 3000K dali n55 5
Vb4.673.003 nero55 3000K dali n55 5

Ra	R9	ies tm-30		sdc	mA	V _{f (min)}	lm	W	lm/W
98	98	Rf 96	Rg 103	step 1	700	28,4	2140	19,9	108
xm001	les19	Ta25 °C		vita media · average life		70000 h	L80	B10	

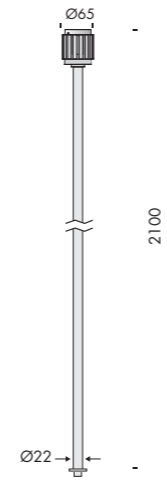

ticablo asta

- Vb4.675.111** ottone naturale · natural brass 3000K les19 n55 0,3
Vb4.675.113 argento hacca 3000K les19 n55 0,3
Vb4.675.112 nero55 3000K les19 n55 0,3

Ra	R9	ies tm-30		sdc	mA	V _{f (min)}	lm	W	lm/W
98	98	Rf 96	Rg 103	step 1	700	28,4	2140	19,9	108
xm001	les19	Ta25 °C		vita media · average life		70000 h	L80	B10	

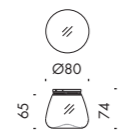

marionanni ☆

Vb9.580.01.t hm01 trasparente · transparent n55 0,05

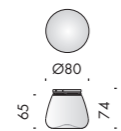

Vb9.580.01.s hm01 sabbata · sanded n55 0,05

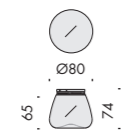

Vb9.580.01.b hm01 bianco latte · milk white n55 0,05

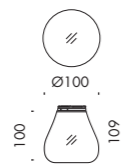

Vb9.580.02.t hm02 trasparente · transparent n55 0,1

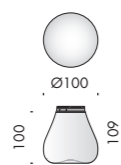

Vb9.580.02.s hm02 sabbata · sanded n55 0,1

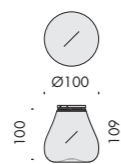

Vb9.580.02.b hm02 bianco latte · milk white n55 0,1

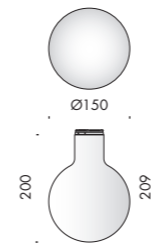

marionanni ☆

Vb9.580.03.s mn01 sabbata · sanded n55 0,3

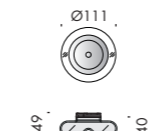

Vb9.580.173.b mn06 tabacchiera
bianco satinato · white frosted n55 0,1

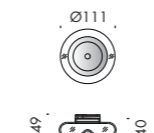

Vb9.580.173.cr mn06 tabacchiera
trasparente cromata · transparent chromed n55 0,1



Vb9.580.178 mn07 trasparente sabbata · transparent sanded n55 0,1



david chipperfield ☆ UK CE i

Vb9.580.05.s dc01 sabbiato · sanded n55 0,1

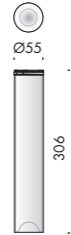

Vb9.580.06.s dc02 sabbiato · sanded n55 0,3

peter zumthor ☆ UK CE i

Vb9.580.08.t pz01 trasparente · transparent n55 0,3

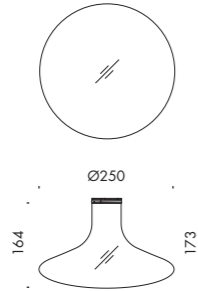

Vb9.580.11.t pz03 trasparente · transparent n55 0,2

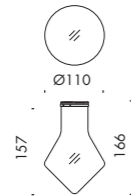

Vb9.580.11.s pz03 sabbiato · sanded n55 0,2

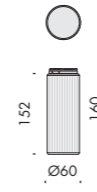
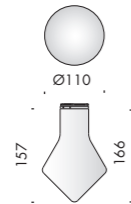

al-jawad pike ☆ UK CE i

Vb9.580.18.tr ajp01 trasparente, rigato · transparent, striped n55 0,2

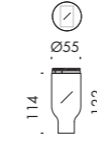

kengo kuma ☆ UK CE i

Vb9.580.07.c kk01 cristallo · crystal n55 0,3

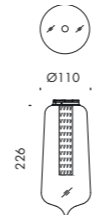

marcio kogan ☆ UK CE i

Vb9.580.111.t mk01 trasparente · transparent n55 0,4

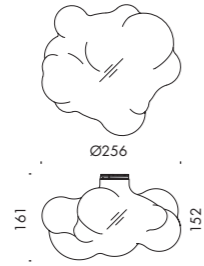

winy maas ★

Vb9.580.09.t wm01 trasparente · transparent n55 0,6



mirko spaccapanico ★

Vb9.580.175.t ms02 trasparente · transparent n55 0,2



Vb9.580.176.t ms03 trasparente · transparent n55 0,2

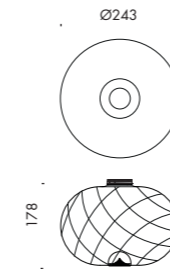

Vb9.580.177.t ms04 trasparente · transparent n55 0,5



lettura delle tabelle tecniche how to read technical tables

xxxxxxxxxxxxxxxx										230V 50-60Hz		A	⊕	IP66	⚡	UL	CE	🔒
a	b	c	d	e	f	g	g	h	i									

xxxxxxxxxxxxxxxx										230V 50-60Hz		A	⊕	IP66	⚡	UL	CE	🔒	
Vbx.xxx.xx	nero55	3000K		35W						1,5									
l	m	n		o						i									

componenti. components. IK10 CE 🔒

accessori. accessories. IK10 CE 🔒

1	2	3	4	5	6	7	8	9											
Ra	R9	ies tm-30		sdcM	mA	V _{f (min)}	lm	W	lm/W										
98	98	Rf 96	Rg 103	step 1	350	27,6	1240	9,7	128										
					500	27,9	1580	14,0	113										
xm000	les19	☀️	Ta25 °C	vita media · average life	70000 h	L80	B10												
10	11							12	13										

bandella tecnica. posizioni standard simbologie.
data plate. standard arrangement of symbols.

a	nome apparecchio di illuminazione · light fitting name
b	tensione di alimentazione · supply rating (Volt)
c	frequenza di alimentazione · supply frequency (Hertz)
d	alimentatore incluso o escluso · power supply included or not included
e	classe di isolamento · insulation class
f	grado di protezione · protection degree
g	marchio di certificazione · safety and quality standards certification
h	conforme alle direttive europee produced in compliance with EC directives
i	peso netto · net weight (kg)
l	codice · code
m	finitura · finish
n	temperatura colore sorgente elettronica colour temperature led source (Kelvin)
o	potenza della sorgente · source power (Watt)

componenti. identifica tutti gli elementi indispensabili per la corretta funzionalità e installazione dell'apparecchio di illuminazione.
components. includes all items that are essential to the correct operation and installation of the light fitting.



accessori. si riferisce alle ulteriori parti installabili sull'apparecchio.
accessories. refers to items that can be added to the light fitting.

1	indice di resa cromatica · colour rendering index
2	indice di resa del rosso · red colour rendering index
3	Rf indice di fedeltà colore · colour fidelity index Rg indice di saturazione colore · color gamut index
4	step di macadam · macadam step
5	corrente di alimentazione · power supply current
6	tensione di alimentazione · power supply voltage
7	flusso luminoso · light flux
8	potenza della sorgente · source power
9	efficienza della sorgente · source efficiency
10	codice sorgente elettronica Viabizzuno · Viabizzuno led source code
11	superficie emittente · light emitting surface (mm)
12	% flusso residuo a fine vita · end life % flux
13	% consentita sotto limite · allowed % under limit

gradi di protezione protection degrees

IPX0	non protetto no protection	IK01	nessuna protezione no protection
IPX1	protetto contro la caduta verticale di gocce d'acqua protected against water drops falling vertically	IK01	protetto contro l'energia d'urto 0,15J protected against collision energy
IPX2	protetto contro la caduta di gocce con inclinazione max 15° protected against water drops max inclination 15°	IK02	protetto contro l'energia d'urto 0,2J protected against collision energy
IPX3	protetto contro la caduta di gocce con inclinazione max 60° protected against water drops max inclination 60°	IK03	protetto contro l'energia d'urto 0,35J protected against collision energy
IPX4	protetto contro spruzzi d'acqua protected against sprinkling water	IK04	protetto contro l'energia d'urto 0,5J protected against collision energy
IPX5	protetto contro getti d'acqua protected against water jets	IK05	protetto contro l'energia d'urto 0,7J protected against collision energy
IPX6	protetto contro inondazioni protected against flooding	IK06	protetto contro l'energia d'urto 1J protected against collision energy
IPX7	per breve immersione protected against brief immersions	IK07	protetto contro l'energia d'urto 2J protected against collision energy
IPX8	per immersione prolungata protected against long immersion	IK08	protetto contro l'energia d'urto 5J protected against collision energy
IP0X	non protetto no protection	IK09	protetto contro l'energia d'urto 10J protected against collision energy
IP1X	contro corpi estranei >50 mm protection against solid objects	IK10	protetto contro l'energia d'urto 20J protected against collision energy
IP2X	contro corpi estranei >12 mm protection against solid objects		
IP3X	contro corpi estranei >2,5 mm protection against solid objects		
IP4X	contro corpi estranei >1 mm protection against solid objects		
IP5X	protezione da polvere dust-protected		
IP6X	stagno alla polvere dust-proof		

legenda simboli symbols key

ta	<i>tavolo</i> · table
tr	<i>terra</i> · floor standing
s	<i>soffitto</i> · ceiling
p	<i>parete</i> · wall
sp	<i>sospensione</i> · suspension
bin	<i>binario</i> · track
in	<i>incasso</i> · recessed
st	<i>scomparsa totale</i> · fully concealed
s+e	<i>segnaletica+emergenza</i> · signalling system+emergency
bat	<i>portatili autoalimentati a batteria</i> · portable self-powered with battery
sis	<i>sistemi</i> · systems
pa	<i>palo</i> · pole
pt	<i>palletto</i> · bollard
sd	<i>seduta</i> · sitting
V	<i>disponibile su</i> · available on <i>Viabizzuno applight</i> <i>www.Viabizzuno.com</i> <i>Viabizzuno online</i>
	<i>classe I. solo isolamento fondamentale, le parti conduttrici accessibili sono collegate ad un conduttore di terra. messa a terra tassativa</i> class I. only basic insulation, accessible conductors are earthed. earthing compulsory
	<i>classe II. all'isolamento principale è aggiunto un secondo isolamento oppure ai due isolamenti è sostituito un isolamento rinforzato. messa a terra esclusa</i> class II. basic insulation plus second insulation or both are replaced by reinforced insulation. earthing excluded
	<i>classe III. alimentazione effettuata con bassissima tensione di sicurezza; sono escluse tensioni superiori a 50V-50Hz. messa a terra non prevista.</i> class III. very low safety supply tension; not to be used over 50V-50Hz. earthing excluded.
CE	<i>prodotto conforme alle direttive europee</i> · produced in compliance with ec directives
	<i>marchio di certificazione europea. certifica che il prodotto è conforme alle norme europee sulla sicurezza</i> component approved for north american market and suitable to be used and approved as part of a more complex system
c us	<i>componente certificato per il mercato nord americano idoneo ad essere utilizzato e valutato come parte di in un sistema più complesso</i> component approved for north american market and suitable to be used and approved as part of a more complex system
KEMA	<i>apparecchio di illuminazione approvato da kema</i> · kema approved light fitting
WRAS	<i>prodotto conforme agli standard presenti nel regno unito che regolamentano la sicurezza e la qualità dell'acqua</i> · product complies with uk standards set out by water regulations
	<i>apparecchio di illuminazione certificato secondo le normative vigenti in polonia che regolamentano i dispositivi di sicurezza antincendio</i> certified light fitting according to the regulations about devices for fire safety in force in poland
	<i>prodotto idoneo per essere commercializzato nel mercato cinese</i> · product suitable for the china market
	<i>prodotto finito idoneo per essere commercializzato nel mercato nord americano</i> · listed product suitable for the north american market
UK CA	<i>prodotto conforme alla legislazione vigente nel regno unito</i> · produced in compliance with UK legislation
	<i>apparecchio di illuminazione certificato per il mercato cinese</i> light fitting certified for china market

	<i>vetro opalino</i> · opal glass
	<i>vetro sabbiato</i> · sanded glass
	<i>vetro nero fumè</i> · black smoke glass
	<i>vetro trasparente</i> · transparent glass
	<i>vetro bianco latte</i> · white milk glass
	<i>cristallo</i> · crystal
	<i>policarbonato opalino</i> · opal polycarbonate diffuser
	<i>carrabile</i> · drive over
A	<i>alimentatore incluso</i> · power supply included
	<i>alimentatore escluso</i> · power supply not included
AR	<i>alimentatore remoto incluso</i> · remote power supply included
Ai	<i>alimentatore elettronico con controllo intelligente incluso</i> · electronic power supply with smart control included
AiR	<i>alimentatore elettronico con controllo intelligente incluso, da installare remoto</i> · electonic power supply with smart control included, to be installed remotely
AS	<i>alimentatore a spina incluso</i> · plug power supply included
T	<i>trasformatore incluso</i> · transformer included
	<i>trasformatore escluso</i> · transformer not included
K	<i>kit di cablaggio</i> · wiring kit
	<i>kit di cablaggio escluso</i> · wiring kit not included
L	<i>lampadina con sorgente elettronica led, ad incandescenza, alogena o fluorescente inclusa.</i> bulb with led electronic source, incandescent, halogen or fluoresecent included.
	<i>lampadina con sorgente elettronica led, ad incandescenza, alogena o fluorescente esclusa.</i> bulb with led electronic source, incandescent, halogen or fluoresecent not included.
Pr	<i>propulsore dinamico n55 incluso</i> · included
	<i>propulsore dinamico n55 escluso</i> · not included
df	<i>diffusore incluso</i> · diffuser included
	<i>diffusore escluso</i> · diffuser not included
	<i>possibilità di combinazione tra interfaccia n55, propulsore dinamico n55 e lampadina n55</i> · possible combination between n55 interface, propulsore dinamico n55 and n55 bulb
	<i>attenzione: sorgente luminosa led. non guardare mai direttamente a occhio nudo</i> · attention: led light source. never look straight without eye protection
ff	<i>flicker free compatibile con fotocamere digitali</i> · flicker free digital camera friendly
l.d.	<i>luce diretta</i> · direct light
l.i.	<i>luce indiretta</i> · indirect light
.d1	<i>dimmerazione 1-10V</i> · 1-10V dimmable
.d2	<i>dimmerazione dali</i> · dimmable dali
.SA	<i>kit luce + emergenza sempre accese. attenzione: non è possibile installare nelle cassafornne laterizio</i> light kit + permanently lit emergency lamp. please note: cannot be installed in brickwork housing
.SE	<i>solo emergenza sempre accesa. attenzione: non è possibile installare nelle cassafornne laterizio</i> permanently lit emergency lamp only. please note: cannot be installed in brickwork housing
i	<i>peso netto</i> · net weight (kg)