



*Viabizzuno strada principale della frazione di bizzuno in provincia di ravenna dove tra la casa del popolo e la parrocchia, al n°17, sono nato il ventuno luglio millenovecentocinquantacinque. da qui nasce il nome della fabbrica di produzione fondata nel millenovecentonovantaquattro rappresentata da uno spazio bianco attraversato da due linee. una verticale, rigorosa, essenziale, equilibrata: la luce per la luce; ed una inclinata, irriverente nello spazio, ironica, fuori dagli schemi: la luce per la forma. distinte ma complementari si fondono in un unico nome: Viabizzuno.*

*marionanni*

Viabizzuno is the name of the main road of the small village bizzuno located in the province of ravenna, where I was born on the twenty-first july nineteenfiftyfive at n°17, between the 'casa del popolo' and the local parish church. from here the name of the factory founded in nineteen ninety-four represented by a white space intersected by two lines. one vertical, well balanced, logical, essential: the light for the light. the other one dynamic, irreverent, ironic: the light for the form. separate and yet complementary they cast in the same name: Viabizzuno.

prodotto  
product



schede tecniche  
data sheets



curve fotometriche  
photometric curves



modelli 3d per i tuoi render  
3d models for your render





**apparecchio di illuminazione da incasso per interni ed esterni IP67. composto da corpo cilindrico diametro Ø25mm in acciaio inox.**  
**modelli:**  
**zero spot con borchia tonda con battuta o scomparsa totale disponibile con ottiche intercambiabili 11° 18° 30° 43° o ellittica 9°x48°**  
**zero side emitter luce diffusa con borchia in metacrilato satinato e borchia metacrilato satinata e acciaio inox**  
**cablato con sorgente elettronica 2700K fino a 1,4W 131lm o 3000K fino a 1,4W 139lm. connettore di alimentazione m8.**  
**prodotto idoneo per installazione in ambiente marino.**  
**accessori: cassaforma laterizio, ghiera per scomparsa totale, molla per installazione incasso e box di derivazione corrente costante.**  
**finiture: acciaio inox, polimetilmetacrilato satinato.**

**IP67 rated recessed light fitting for indoor and outdoor use. it consists of a diameter Ø25mm cylindrical body made of stainless steel.**  
**models:**  
**zero spot with round bezel with trim or fully concealed bezel is available with replaceable 11° 18° 30° 43° optics or 9°x48° elliptical optic.**  
**zero side emitter diffused light with bezel in satin polymethyl methacrylate and satin polymethyl methacrylate and stainless steel.**  
**wired with 2700K up to 1.4W 131lm or 3000K up to 1.4W 139lm led source.**  
**product suitable for installation in a marine environment.**  
**accessories: brick housing, ring nut fully concealed, spring for recessed installation and constant current derivation hub.**  
**finishes: stainless steel, satin polymethyl methacrylate.**

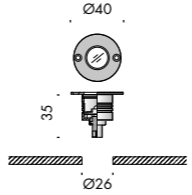

zero spot		IK02		IP67		★ UK CE i	
<b>Vb6.164.01.27</b>		acciaio inox · stainless steel		2700K 30°		0,1	
Ra	ies tm-30	sdc	mA	V <sub>f</sub>	lm	W	lm/W
90	Rf 90 Rg 100	step 2	350	2,8	95	1,0	95
			500	2,8	131	1,4	94
Vz120	les3	Ta25 °C		vita media · average life		50000 h	L80 B10

<b>Vb6.164.01.30</b>		acciaio inox · stainless steel		3000K 30°		0,1	
Ra	ies tm-30	sdc	mA	V <sub>f</sub>	lm	W	lm/W
90	Rf 90 Rg 100	step 2	350	2,8	101	1,0	101
			500	2,8	139	1,4	99
Vz121	les3	Ta25 °C		vita media · average life		50000 h	L80 B10

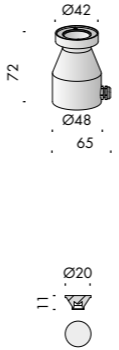
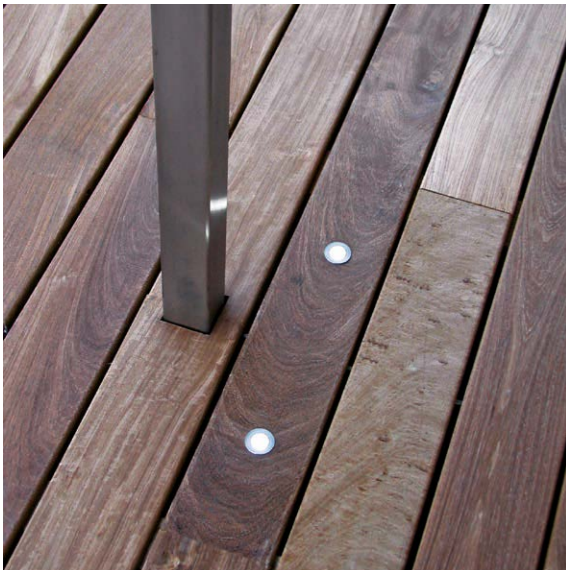

cassaforma incasso laterizio. brick housing for recessed body.		★ UK CE i	
<b>f9.164.82</b>	cassaforma per borchia con viti housing for bezel with screws	0,2	

ottiche zero spot. optics.		★ UK CE i	
<b>f9.164.95</b>	11°	20mm	0,01
<b>f9.164.96</b>	18°	20mm	0,01
<b>f9.164.97</b>	43°	20mm	0,01
<b>f9.164.98</b>	ellittica · elliptic 9°x48°	20mm	0,01

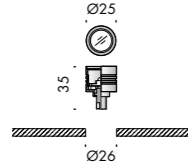

**zero spot scomparsa totale** IK02 IP67 ★ UK CE i

**Vb6.164.02.27** acciaio inox, ghiera per fissaggio da retro inclusa  
stainless steel, ring nut for fastening from behind included 2700K 30° 0,1

Ra	ies tm-30		sdc	mA	V <sub>f</sub>	lm	W	lm/W
90	Rf 90	Rg 100	step 2	350	2,8	95	1,0	95
				500	2,8	131	1,4	94
Vz120	les3		Ta25 °C		vita media · average life		50000 h	L80 B10

**Vb6.164.02.30** acciaio inox, ghiera per fissaggio da retro inclusa  
stainless steel, ring nut for fastening from behind included 3000K 30° 0,1

Ra	ies tm-30		sdc	mA	V <sub>f</sub>	lm	W	lm/W
90	Rf 90	Rg 100	step 2	350	2,8	101	1,0	101
				500	2,8	139	1,4	99
Vz121	les3		Ta25 °C		vita media · average life		50000 h	L80 B10



**ottiche zero spot. optics.** UK CE i

<b>f9.164.95</b>	11°	20mm	0,01
<b>f9.164.96</b>	18°	20mm	0,01
<b>f9.164.97</b>	43°	20mm	0,01
<b>f9.164.98</b>	ellittica · elliptic 9°x48°	20mm	0,01

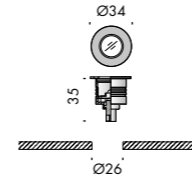

**zero spot incasso** IK02 IP67 ★ UK CE i

**Vb6.164.03.27** acciaio inox, molle per incasso incluse  
stainless steel, springs for recessed included 2700K 30° 0,1

Ra	ies tm-30		sdc	mA	V <sub>f</sub>	lm	W	lm/W
90	Rf 90	Rg 100	step 2	350	2,8	95	1,0	95
				500	2,8	131	1,4	94
Vz120	les3		Ta25 °C		vita media · average life		50000 h	L80 B10

**Vb6.164.03.30** acciaio inox, molle per incasso incluse  
stainless steel, springs for recessed included 3000K 30° 0,1

Ra	ies tm-30		sdc	mA	V <sub>f</sub>	lm	W	lm/W
90	Rf 90	Rg 100	step 2	350	2,8	101	1,0	101
				500	2,8	139	1,4	99
Vz121	les3		Ta25 °C		vita media · average life		50000 h	L80 B10

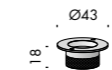
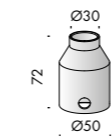
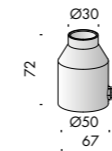

**cassaforma incasso laterizio. brick housing for recessed body.** UK CE i

**f9.164.80.1** cassaforma per borchia senza viti  
housing for bezel without screws 0,2

**f9.164.84** cassaforma per borchia senza viti con foro  
housing with hole for bezel without screws 0,2

**accessori. accessories.** UK CE i

**f9.164.83** ghiera per fissaggio da retro  
ring nut for fastening from behind 0,2

**ottiche zero spot. optics.** UK CE i

<b>f9.164.95</b>	11°	20mm	0,01
<b>f9.164.96</b>	18°	20mm	0,01
<b>f9.164.97</b>	43°	20mm	0,01
<b>f9.164.98</b>	ellittica · elliptic 9°x48°	20mm	0,01

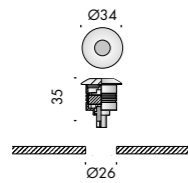
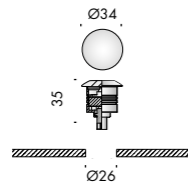

**zero side emitter**

**Vb6.164.11.27** acciaio inox con diffusore satinato, molle per incasso incluse  
 stainless steel with sanded diffusing, springs for recessed included 2700K 0,1

Ra	ies tm-30		sdc	mA	V <sub>f</sub>	lm	W	lm/W
90	Rf 90	Rg 100	step 2	350	2,8	95	1,0	95
				500	2,8	131	1,4	94
Vz120	les3	Ta25 °C		vita media · average life		50000 h	L80	B10

**Vb6.164.11.30** acciaio inox con diffusore satinato, molle per incasso incluse  
 stainless steel with sanded diffusing, springs for recessed included 3000K 0,1

Ra	ies tm-30		sdc	mA	V <sub>f</sub>	lm	W	lm/W
90	Rf 90	Rg 100	step 2	350	2,8	101	1,0	101
				500	2,8	139	1,4	99
Vz121	les3	Ta25 °C		vita media · average life		50000 h	L80	B10

**Vb6.164.12.27** acciaio inox con diffusore satinato e acciaio, molle per incasso incluse  
 stainless steel with sanded diffusing and steel, springs for recessed included 2700K 0,1

Ra	ies tm-30		sdc	mA	V <sub>f</sub>	lm	W	lm/W
90	Rf 90	Rg 100	step 2	350	2,8	95	1,0	95
				500	2,8	131	1,4	94
Vz120	les3	Ta25 °C		vita media · average life		50000 h	L80	B10

**Vb6.164.12.30** acciaio inox con diffusore satinato e acciaio, molle per incasso incluse  
 stainless steel with sanded diffusing and steel, springs for recessed included 3000K 0,1

Ra	ies tm-30		sdc	mA	V <sub>f</sub>	lm	W	lm/W
90	Rf 90	Rg 100	step 2	350	2,8	101	1,0	101
				500	2,8	139	1,4	99
Vz121	les3	Ta25 °C		vita media · average life		50000 h	L80	B10

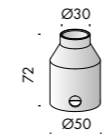
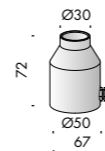

**cassaforma incasso laterizio. brick housing for recessed body.**

**f9.164.80.1** cassaforma per borchia senza viti  
 housing for bezel without screws 0,2

**f9.164.84** cassaforma per borchia senza viti con foro  
 housing with hole for bezel without screws 0,2

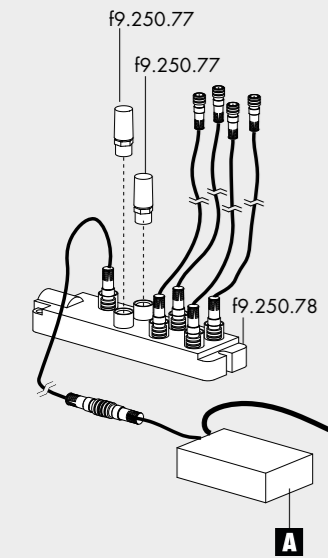
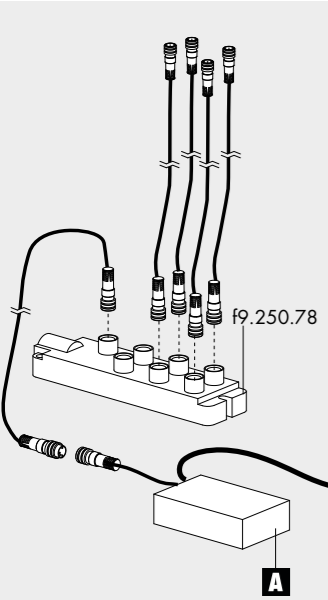

attenzione: è obbligatorio inserire f9.250.77 in tutte le derivazioni non utilizzate  
 please note: it is compulsory to insert f9.250.77 in all the not used shunts

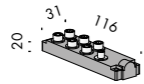
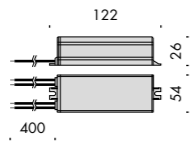

**alimentatori. power supplies.** 240V 50-60Hz **A** IP67

- f4.411-2** con connettore m8 tensione sul secondario with m8 connector voltage on the secondary 2-49V 17W 350mA 0,2
- f4.412-2** con connettore m8 tensione sul secondario with m8 connector voltage on the secondary 3-36V 18W 500mA 0,2

**cavi con connettori m/f m8. cables with m8 m/f connectors.** IP65

- f9.250.72** 2000mm 0,1
- f9.250.73** 5000mm 0,3
- f9.250.74** 10000mm 0,5

**cavi con connettore femmina m8. cables with m8 female connector.** IP65

- f9.250.70** 150mm 0,01
- f9.164.86** 2000mm 0,1
- f9.164.87** 5000mm 0,2
- f9.164.88** 10000mm 0,3

**sistema di derivazione corrente costante. cc derivation hub.**

- f9.250.78** con 6 connettori femmina +1 connettore maschio m8 with 6 female connectors +1 male connector m8 0,1
- f9.250.77** tappo maschio bypass per f9.250.78 male bypass caps 0,1



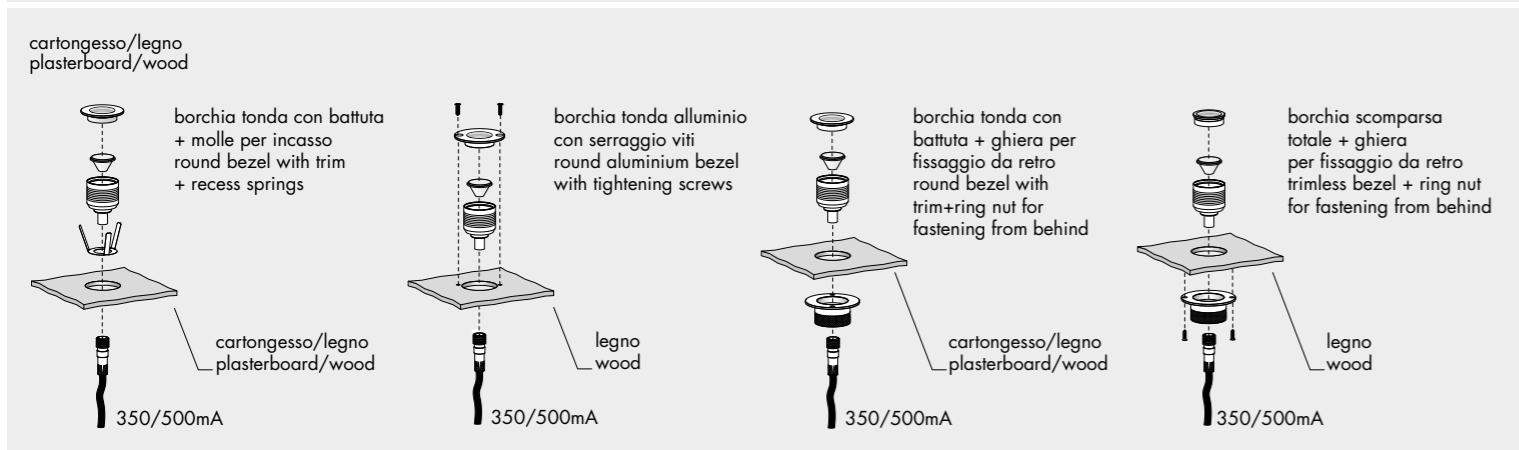
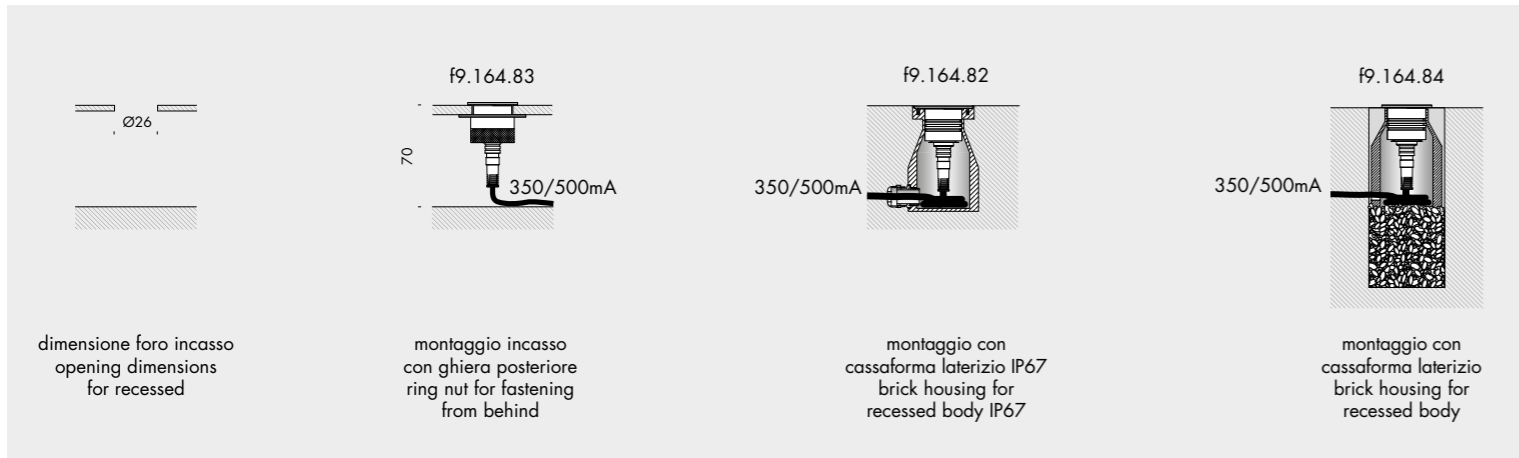

## lettura delle tabelle tecniche how to read technical tables

xxxxxxxxxxxxxxxx										230V 50-60Hz		A	IP66	UL	CE	i
a	b	c	d	e	f	g	g	h	i							

xxxxxxxxxxxxxxxx										230V 50-60Hz		A	IP66	UL	CE	i
Vbx.xxx.xx		nero55	3000K		35W		1,5									
l	m		n	o												

componenti. components.										IK10		CE	i
-------------------------	--	--	--	--	--	--	--	--	--	------	--	----	---

accessori. accessories.										IK10		CE	i
-------------------------	--	--	--	--	--	--	--	--	--	------	--	----	---

1	2	3	4	5	6	7	8	9	10
Ra	R9	ies tm-30	sdcm	mA	V <sub>f (min)</sub>	lm	W	lm/W	
98	98	Rf 96 Rg 103	step 1	350 500	27,6 27,9	1240 1580	9,7 14,0	128 113	A++ A+
xm000	les19	Ta25 °C	vita media · average life	70000 h	L80	B10			
11	12							13	14

bandella tecnica. posizioni standard simbologie.  
data plate. standard arrangement of symbols.

a	nome apparecchio di illuminazione · light fitting name
b	tensione di alimentazione · supply rating (Volt)
c	frequenza di alimentazione · supply frequency (Hertz)
d	alimentatore incluso o escluso · power supply included or not included
e	classe di isolamento · insulation class
f	grado di protezione · protection degree
g	marchio di certificazione · safety and quality standards certification
h	conforme alle direttive europee produced in compliance with EC directives
i	peso netto · net weight (kg)
l	codice · code
m	finitura · finish
n	temperatura colore sorgente elettronica colour temperature led source (Kelvin)
o	potenza della sorgente · source power (Watt)

componenti. identifica tutti gli elementi indispensabili per la corretta funzionalità e installazione dell'apparecchio di illuminazione.  
components. includes all items that are essential to the correct operation and installation of the light fitting.

accessori. si riferisce alle ulteriori parti installabili sull'apparecchio.  
accessories. refers to items that can be added to the light fitting.

1	indice di resa cromatica · colour rendering index
2	indice di resa del rosso · red colour rendering index
3	Rf indice di fedeltà colore · colour fidelity index Rg indice di saturazione colore · color gamut index
4	step di macadam · macadam step
5	corrente di alimentazione · power supply current
6	tensione di alimentazione · power supply voltage
7	flusso luminoso · light flux
8	potenza della sorgente · source power
9	efficienza della sorgente · source efficiency
10	classe di efficienza energetica · efficiency class
11	codice sorgente elettronica Viabizzuno · Viabizzuno led source code
12	superficie emittente · light emitting surface (mm)
13	% flusso residuo a fine vita · end life % flux
14	% consentita sotto limite · allowed % under limit

## gradi di protezione protection degrees

IPOX	non protetto no protection
IP1X	contro corpi estranei >50 mm protection against solid objects
IP2X	contro corpi estranei >12 mm protection against solid objects
IP3X	contro corpi estranei >2,5 mm protection against solid objects
IP4X	contro corpi estranei >1 mm protection against solid objects
IP5X	protezione da polvere dust-protected
IP6X	stagno alla polvere dust-proof

IPX0	non protetto no protection
IPX1	protetto contro la caduta verticale di gocce d'acqua protected against water drops falling vertically
IPX2	protetto contro la caduta di gocce con inclinazione max 15° protected against water drops max inclination 15°
IPX3	protetto contro la caduta di gocce con inclinazione max 60° protected against water drops max inclination 60°
IPX4	protetto contro spruzzi d'acqua protected against sprinkling water
IPX5	protetto contro getti d'acqua protected against water jets
IPX6	protetto contro inondazioni protected against flooding
IPX7	per breve immersione protected against brief immersions
IPX8	per immersione prolungata protected against long immersion

IK01	nessuna protezione no protection
IK01	protetto contro l'energia d'urto 0,15J protected against collision energy
IK02	protetto contro l'energia d'urto 0,2J protected against collision energy
IK03	protetto contro l'energia d'urto 0,35J protected against collision energy
IK04	protetto contro l'energia d'urto 0,5J protected against collision energy
IK05	protetto contro l'energia d'urto 0,7J protected against collision energy
IK06	protetto contro l'energia d'urto 1J protected against collision energy
IK07	protetto contro l'energia d'urto 2J protected against collision energy
IK08	protetto contro l'energia d'urto 5J protected against collision energy
IK09	protetto contro l'energia d'urto 10J protected against collision energy
IK10	protetto contro l'energia d'urto 20J protected against collision energy

## legenda simboli symbols key

<b>ta</b>	<i>tavolo</i> · table
<b>tr</b>	<i>terra</i> · floor standing
<b>s</b>	<i>soffitto</i> · ceiling
<b>p</b>	<i>parete</i> · wall
<b>sp</b>	<i>sospensione</i> · suspension
<b>bin</b>	<i>binario</i> · track
<b>in</b>	<i>incasso</i> · recessed
<b>st</b>	<i>scomparsa totale</i> · fully concealed
<b>s+e</b>	<i>segnaletica+emergenza</i> · signalling system+emergency
<b>bat</b>	<i>portatili autoalimentati a batteria</i> · portable self-powered with battery
<b>sis</b>	<i>sistemi</i> · systems
<b>pa</b>	<i>palo</i> · pole
<b>pt</b>	<i>paletto</i> · bollard
<b>sd</b>	<i>seduta</i> · sitting
<b>V</b>	<i>disponibile su</i> · available on <i>Viabizzuno applight</i> <i>www.Viabizzuno.com</i> <i>Viabizzuno online</i>
	<i>classe I. solo isolamento fondamentale, le parti conduttrici accessibili sono collegate ad un conduttore di terra. messa a terra tassativa</i> class I. only basic insulation, accessible conductors are earthed. earthing compulsory
	<i>classe II. all'isolamento principale è aggiunto un secondo isolamento oppure ai due isolamenti è sostituito un isolamento rinforzato. messa a terra esclusa</i> class II. basic insulation plus second insulation or both are replaced by reinforced insulation. earthing excluded
	<i>classe III. alimentazione effettuata con bassissima tensione di sicurezza; sono escluse tensioni superiori a 50V-50Hz. messa a terra non prevista.</i> class III. very low safety supply tension; not to be used over 50V-50Hz. earthing excluded.
	<i>prodotto conforme alle direttive europee</i> · produced in compliance with ec directives
	<i>marchio di certificazione europea. certifica che il prodotto è conforme alle norme europee sulla sicurezza</i> component approved for north american market and suitable to be used and approved as part of a more complex system
	<i>componente certificato per il mercato nord americano idoneo ad essere utilizzato e valutato come parte di in un sistema più complesso</i> component approved for north american market and suitable to be used and approved as part of a more complex system
	<i>apparecchio di illuminazione approvato da kema</i> · kema approved light fitting
	<i>prodotto conforme agli standard presenti nel regno unito che regolamentano la sicurezza e la qualità dell'acqua</i> · product complies with uk standards set out by water regulations
	<i>apparecchio di illuminazione certificato secondo le normative vigenti in polonia che regolamentano i dispositivi di sicurezza antincendio</i> certified light fitting according to the regulations about devices for fire safety in force in poland
	<i>prodotto idoneo per essere commercializzato nel mercato cinese</i> · product suitable for the china market
	<i>prodotto finito idoneo per essere commercializzato nel mercato nord americano</i> · listed product suitable for the north american market
	<i>prodotto conforme alla legislazione vigente nel regno unito</i> · produced in compliance with UK legislation
	<i>apparecchio di illuminazione certificato per il mercato cinese</i> light fitting certified for china market

	<i>vetro opalino</i> · opal glass
	<i>vetro sabbiato</i> · sanded glass
	<i>vetro nero fumè</i> · black smoke glass
	<i>vetro trasparente</i> · transparent glass
	<i>vetro bianco latte</i> · white milk glass
	<i>crystallo</i> · crystal
	<i>policarbonato opalino</i> · opal polycarbonate diffuser
	<i>carrabile</i> · drive over
	<i>alimentatore incluso</i> · power supply included
	<i>alimentatore escluso</i> · power supply not included
	<i>alimentatore remoto incluso</i> · remote power supply included
	<i>alimentatore elettronico con controllo intelligente incluso</i> · electronic power supply with smart control included
	<i>alimentatore elettronico con controllo intelligente incluso, da installare remoto</i> · electronic power supply with smart control included, to be installed remotely
	<i>alimentatore a spina incluso</i> · plug power supply included
	<i>trasformatore incluso</i> · transformer included
	<i>trasformatore escluso</i> · transformer not included
	<i>kit di cablaggio</i> · wiring kit
	<i>kit di cablaggio escluso</i> · wiring kit not included
	<i>lampadina con sorgente elettronica led, ad incandescenza, alogena o fluorescente inclusa.</i> bulb with led electronic source, incandescent, halogen or fluorescent included.
	<i>lampadina con sorgente elettronica led, ad incandescenza, alogena o fluorescente esclusa.</i> bulb with led electronic source, incandescent, halogen or fluorescent not included.
	<i>propulsore dinamico n55 incluso</i> · included
	<i>possibilità di combinazione tra interfaccia n55, propulsore dinamico n55 e lampadina n55</i> · possible combination between n55 interface, propulsore dinamico n55 and n55 bulb
	<i>attenzione: sorgente luminosa led. non guardare mai direttamente a occhio nudo</i> · attention: led light source. never look straight without eye protection
	<i>flicker free compatibile con fotocamere digitali</i> · flicker free digital camera friendly
<b>l.d.</b>	<i>luce diretta</i> · direct light
<b>l.i.</b>	<i>luce indiretta</i> · indirect light
<b>.d1</b>	<i>dimmerazione 1-10V</i> · 1-10V dimmable
<b>.d2</b>	<i>dimmerazione dali</i> · dimmable dali
<b>.SA</b>	<i>kit luce + emergenza sempre accese. attenzione: non è possibile installare nelle cassaforme laterizio</i> light kit + permanently lit emergency lamp. please note: cannot be installed in brickwork housing
<b>.SE</b>	<i>solo emergenza sempre accesa. attenzione: non è possibile installare nelle cassaforme laterizio</i> permanently lit emergency lamp only. please note: cannot be installed in brickwork housing
	<i>peso netto</i> · net weight (kg)