

Viabizzuno strada principale della frazione di bizzuno in provincia di ravenna dove tra la casa del popolo e la parrocchia, al n°17, sono nato il ventuno luglio millenovecentocinquantacinque. da qui nasce il nome della fabbrica di produzione fondata nel millenovecentonovantaquattro rappresentata da uno spazio bianco attraversato da due linee. una verticale, rigorosa, essenziale, equilibrata: la luce per la luce; ed una inclinata, irriverente nello spazio, ironica, fuori dagli schemi: la luce per la forma. distinte ma complementari si fondono in un unico nome: Viabizzuno.

Viabizzuno is the name of the main road of the small village bizzuno located in the province of ravenna, where I was born on the twenty-first july nineteenfiftyfive at n°17, between the 'casa del popolo' and the local parish church. from here the name of the factory founded in nineteen ninety-four represented by a white space intersected by two lines. one vertical, well balanced, logical, essential: the light for the light. the other one dynamic, irreverent, ironic: the light for the form. separate and yet complementary they cast in the same name: Viabizzuno. marionanni

*i progetti rendono gli oggetti eterni,
le mode li corrompono, gli imbecilli li copiano
e li vendono agli ignoranti e ai deficienti.
noi progettiamo e lavoriamo per aiutare la luce
ad emozionarvi.*

*i frutti delle nostre idee e dei nostri progetti
sono protetti da brevetti
e/o modelli registrati
e/o da diritto d'autore.*

design makes objects timeless,
fashion corrupts them,
fools copy them and sell them to
ignorants and idiots.
we do projects and work to help light to bring
you true emotion.
the results of our ideas and our projects
are protected by patents
and/or registered models
and/or copyright.

al fine di offrire ai nostri clienti la massima qualità della luce utilizzando le più avanzate tecnologie, forti del nostro sapere artigiano costruito in italia, aggiorniamo costantemente i nostri apparecchi di illuminazione.

Viabizzuno si riserva il diritto di apportare ai propri modelli, senza nessun preavviso, qualsiasi modifica ritenesse opportuna. per dimensioni e codici fanno fede i nostri strumenti di lavoro www.Viabizzuno.com, Viacommerce@, Viabizzunoapplight e Viabizzunoonline.

in order to provide to our customers the maximum quality of light using the most advanced technologies, being strong of our artisan knowledge made in italy, we constantly update our lighting fixtures.

Viabizzuno reserves the right to make any modification, considered worthwhile, to its own models, without any notification. for valid dimensions and codes please consult our working tools www.Viabizzuno.com, Viacommerce@, Viabizzunoapplight and Viabizzunoonline.

lettura delle tabelle tecniche how to read technical tables

XXXXXXXXXXXXXXXXXX										
230V 50-60Hz				A	⊕	IP66		US	CE	
a	b	c	d	e	f	g	g	h	i	

XXXXXXXXXXXXXXXXXX										
230V 50-60Hz				A	⊕	IP66		US	CE	
Vbx.xxx.xx	nero55	3000K		35W	1,5					
l	m	n	o	i						

componenti. components.	IK10	CE	
--------------------------------	-------------	----	--

accessori. accessories.	IK10	CE	
--------------------------------	-------------	----	--

1	2	3	4	5	6	7	8	9	10
---	---	---	---	---	---	---	---	---	----

Ra	R9	ies tm/30		sdcM	Vf	lm/m	W/m	lm/W	
95	90	Rf 90	Rg 98	step 2	24	1200	13	92	F
V0000	5,9		Ta25 °C	vita media · average life	50000 h	L80	B10		

11	12	13	14
----	----	----	----

bandella tecnica. posizioni standard simbologie.
data plate. standard arrangement of symbols.

a	nome apparecchio di illuminazione · light fitting name
b	tensione di alimentazione · supply rating (Volt)
c	frequenza di alimentazione · supply frequency (Hertz)
d	alimentatore incluso o escluso · power supply included or not included
e	classe di isolamento · insulation class
f	grado di protezione · protection degree
g	marchio di certificazione · safety and quality standards certification
h	conforme alle direttive europee produced in compliance with EC directives
i	peso netto · net weight (kg)
l	codice · code
m	finitura · finish
n	temperatura colore sorgente elettronica colour temperature led source (Kelvin)
o	potenza della sorgente · source power (Watt)

componenti. identifica tutti gli elementi indispensabili per la corretta funzionalità e installazione dell'apparecchio di illuminazione.
components. includes all items that are essential to the correct operation and installation of the light fitting.















accessori. si riferisce alle ulteriori parti installabili sull'apparecchio.
accessories. refers to items that can be added to the light fitting.

1	indice di resa cromatica · colour rendering index
2	indice di resa del rosso · red colour rendering index
3	Rf indice di fedeltà colore · colour fidelity index Rg indice di saturazione colore · color gamut index
4	step di macadam · macadam step
5	corrente di alimentazione · power supply current
6	tensione di alimentazione · power supply voltage
7	flusso luminoso · light flux
8	potenza della sorgente · source power
9	efficienza della sorgente · source efficiency
10	classe di efficienza energetica · efficiency class
11	codice sorgente elettronica Viabizzuno · Viabizzuno led source code
12	superficie emittente · light emitting surface (mm)
13	% flusso residuo a fine vita · end life % flux
14	% consentita sotto limite · allowed % under limit

gradi di protezione protection degrees

IP0X	<i>non protetto</i> no protection	IPX0	<i>non protetto</i> no protection		
IP1X	<i>contro corpi estranei >50 mm</i> protection against solid objects	IPX1	<i>protetto contro la caduta verticale di gocce d'acqua</i> protected against water drops falling vertically	IK01	<i>nessuna protezione</i> no protection
IP2X	<i>contro corpi estranei >12 mm</i> protection against solid objects	IPX2	<i>protetto contro la caduta di gocce con inclinazione max 15°</i> protected against water drops max inclination 15°	IK02	<i>protetto contro l'energia d'urto 0,2J</i> protected against collision energy
IP3X	<i>contro corpi estranei >2,5 mm</i> protection against solid objects	IPX3	<i>protetto contro la caduta di gocce con inclinazione max 60°</i> protected against water drops max inclination 60°	IK03	<i>protetto contro l'energia d'urto 0,35J</i> protected against collision energy
IP4X	<i>contro corpi estranei >1 mm</i> protection against solid objects	IPX4	<i>protetto contro spruzzi d'acqua</i> protected against sprinkling water	IK04	<i>protetto contro l'energia d'urto 0,5J</i> protected against collision energy
IP5X	<i>protezione da polvere</i> dust-protected	IPX5	<i>protetto contro getti d'acqua</i> protected against water jets	IK05	<i>protetto contro l'energia d'urto 0,7J</i> protected against collision energy
IP6X	<i>stagno alla polvere</i> dust-proof	IPX6	<i>protetto contro inondazioni</i> protected against flooding	IK06	<i>protetto contro l'energia d'urto 1J</i> protected against collision energy
		IPX7	<i>per breve immersione</i> protected against brief immersions	IK07	<i>protetto contro l'energia d'urto 2J</i> protected against collision energy
		IPX8	<i>per immersione prolungata</i> protected against long immersion	IK08	<i>protetto contro l'energia d'urto 5J</i> protected against collision energy
				IK09	<i>protetto contro l'energia d'urto 10J</i> protected against collision energy
				IK10	<i>protetto contro l'energia d'urto 20J</i> protected against collision energy

legenda simboli symbols key

-  tavolo · table
-  terra · floor standing
-  soffitto · ceiling
-  parete · wall
-  sospensione · suspension
-  binario · track
-  incasso · recessed
-  scomparsa totale · fully concealed
-  segnaletica+emergenza · signalling system+emergency
-  portatili autoalimentati a batteria · portable self-powered with battery
-  sistemi · systems
-  palo · pole
-  paletto · bollard
-  seduta · sitting

 disponibile su · available on [Viabizzuno aplight](http://Viabizzuno.aplight) www.Viabizzuno.com [Viabizzuno online](http://Viabizzuno.online)

 classe I. solo isolamento fondamentale, le parti conduttrici accessibili sono collegate ad un conduttore di terra. messa a terra tassativa
class I. only basic insulation, accessible conductors are earthed. earthing compulsory

 classe II. all'isolamento principale è aggiunto un secondo isolamento oppure ai due isolamenti è sostituito un isolamento rinforzato. messa a terra esclusa
class II. basic insulation plus second insulation or both are replaced by reinforced insulation. earthing excluded

 classe III. alimentazione effettuata con bassissima tensione di sicurezza; sono escluse tensioni superiori a 50V-50Hz. messa a terra non prevista.
class III. very low safety supply tension; not to be used over 50V-50Hz. earthing excluded.

 prodotto conforme alle direttive europee · produced in compliance with ec directives

 marchio di certificazione europea. certifica che il prodotto è conforme alle norme europee sulla sicurezza
component approved for north american market and suitable to be used and approved as part of a more complex system

 componente certificato per il mercato nord americano idoneo ad essere utilizzato e valutato come parte di in un sistema più complesso
component approved for north american market and suitable to be used and approved as part of a more complex system

 apparecchio di illuminazione approvato da kema · kema approved light fitting

 prodotto conforme agli standard presenti nel regno unito che regolamentano la sicurezza e la qualità dell'acqua · product complies with uk standards set out by water regulations

 apparecchio di illuminazione certificato secondo le normative vigenti in polonia che regolamentano i dispositivi di sicurezza antincendio
certified light fitting according to the regulations about devices for fire safety in force in poland

 prodotto idoneo per essere commercializzato nel mercato cinese · product suitable for the china market

 prodotto finito idoneo per essere commercializzato nel mercato nord americano · listed product suitable for the north american market

 prodotto conforme alla legislazione vigente nel regno unito · produced in compliance with UK legislation

 apparecchio di illuminazione certificato per il mercato cinese
light fitting certified for china market

-  *vetro opalino* · opal glass
-  *vetro sabbiato* · sanded glass
-  *vetro nero fumè* · black smoke glass
-  *vetro trasparente* · transparent glass
-  *vetro bianco latte* · white milk glass
-  *crystallo* · crystal
-  *polycarbonato opalino* · opal polycarbonate diffuser
-  *carrabile* · drive over
- A** *alimentatore incluso* · power supply included
- A** *alimentatore escluso* · power supply not included
- AR** *alimentatore remoto incluso* · remote power supply included
- Ai** *alimentatore elettronico con controllo intelligente incluso* · electronic power supply with smart control included
- AiR** *alimentatore elettronico con controllo intelligente incluso, da installare remoto* · electronic power supply with smart control included, to be installed remotely
- AS** *alimentatore a spina incluso* · plug power supply included
- T** *trasformatore incluso* · transformer included
- T** *trasformatore escluso* · transformer not included
- K** *kit di cablaggio* · wiring kit
- K** *kit di cablaggio escluso* · wiring kit not included
- L** *lampadina con sorgente elettronica led, ad incandescenza, alogena o fluorescente inclusa.*
bulb with led electronic source, incandescent, halogen or fluorescent included.
- L** *lampadina con sorgente elettronica led, ad incandescenza, alogena o fluorescente esclusa.*
bulb with led electronic source, incandescent, halogen or fluorescent not included.
- Pr** *propulsore dinamico n55 incluso* · included
- Pr** *propulsore dinamico n55 escluso* · not included
- df** *diffusore incluso* · diffuser included
- df** *diffusore escluso* · diffuser not included
-  *possibilità di combinazione tra interfaccia n55, propulsore dinamico n55 e lampadina n55* · possible combination between n55 interface, propulsore dinamico n55 and n55 bulb
-  *attenzione: sorgente luminosa led. non guardare mai direttamente a occhio nudo* · attention: led light source. never look straight without eye protection
- ff** *flicker free compatibile con fotocamere digitali* · flicker free digital camera friendly
- l.d.** *luce diretta* · direct light
- l.i.** *luce indiretta* · indirect light
- .d1** *dimmerazione 1-10V* · 1-10V dimmable
- .d2** *dimmerazione dali* · dimmable dali
- .SA** *kit luce + emergenza sempre accese. attenzione: non è possibile installare nelle cassaforme laterizio*
light kit + permanently lit emergency lamp. please note: cannot be installed in brickwork housing
- .SE** *solo emergenza sempre accesa. attenzione: non è possibile installare nelle cassaforme laterizio*
permanently lit emergency lamp only. please note: cannot be installed in brickwork housing
- i** *peso netto* · net weight (kg)

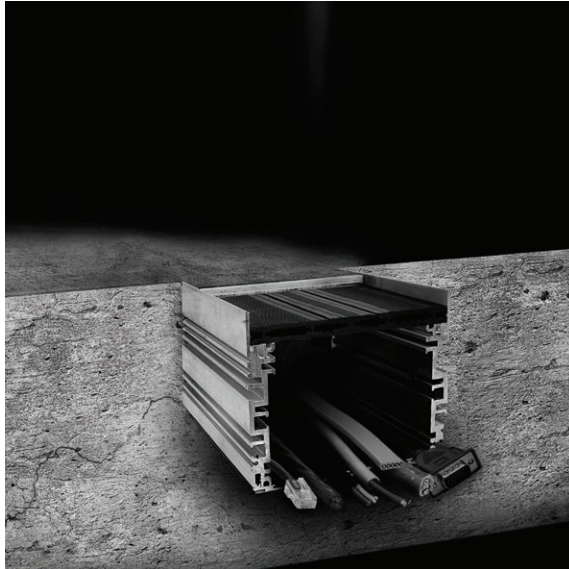

brevettato · patented

*sistema modulare per interni.
realizzato in estruso di alluminio ossidato, studiato per la distribuzione di cavi e altri
componenti elettrici nella pavimentazione.*

modelli:

*aituoipiedi centrale 96 135x96mm 3000mm completo di coperchio calpestabile h.10mm filo
pavimento,*

*aituoipiedi centrale 106 135x106mm 3000mm con coperchio h.10mm predisposto per
alloggiare un rivestimento di spessore di 10mm (pietra, legno, marmo, ceramica),*

*aituoipiedi perimetrale 162 136,5x162mm 3000mm predisposto ad alloggiare
l'apparecchio di illuminazione 13x8 per illuminare le pareti, da acquistare separatamente.
il profilo estruso può essere sezionato per ottenere diverse altezze.*

*il coperchio può essere intervallato con degli sportelli per raggiungere facilmente impianti,
prese ed altri componenti elettrici.*

accessori: sportello cieco, testata di chiusura, giunti lineari, raccordi.

finiture: nero55.

modular system for indoor use.

**made of oxidized extruded aluminium, designed for the distribution of cables and other
floor electrical components.**

versions:

**aituoipiedi centrale 96 135x96mm 3000mm complete with h.10 mm lid that can be
trampled and that is flush with the floor,**

**aituoipiedi centrale 106 135x106mm 3000mm with h.10mm lid designed for a 10mm thick
coating (stone, wood, marble, ceramic),**

**aituoipiedi perimetrale 162 136.5x162mm 3000mm designed to accommodate 13x8 light
fitting for wall lighting, to be purchased separately.**

the extruded profile can be divided to obtain different heights.

**the lid may be staggered with access lids to easily reach systems, sockets and other
electrical components.**

accessories: blind lid, end plate, straight joints, fittings.

finishes: nero55.

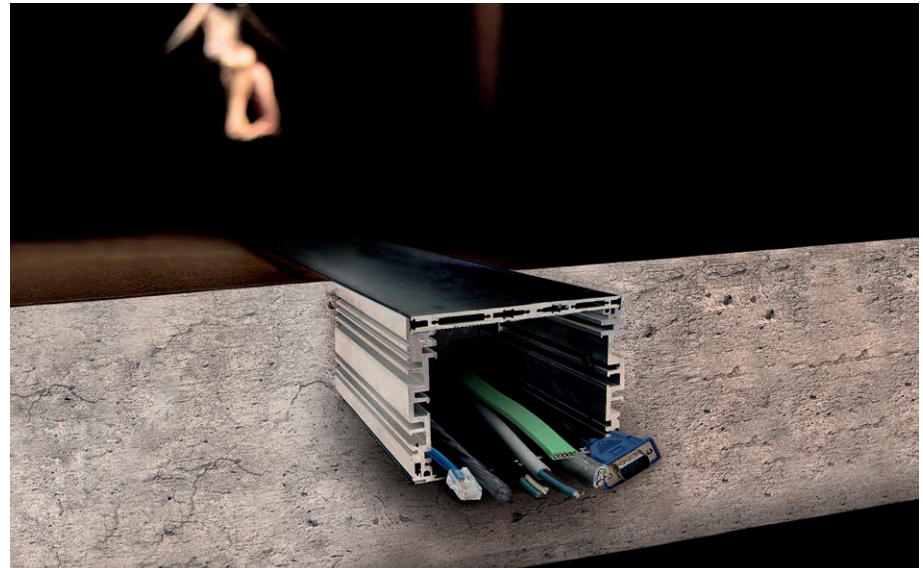

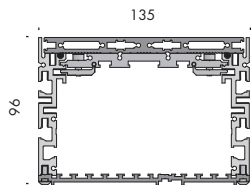

aituoipiedi centrale 96 ★ CE i

f6.223.02 nero55
completo di coperchio · lid included

3000mm 22,4

accessori. accessories. ★ CE i

f6.223.41 sportello di accesso al vano tecnico
technical compartment door

280mm 1,1

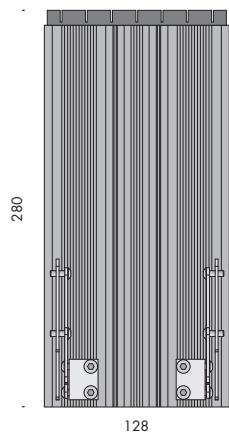

f6.223.20 testata di chiusura · end plate

0,3

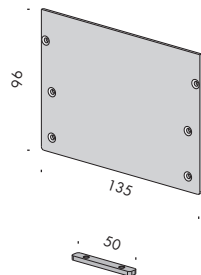

f9.223.80 giunti lineari · linear joints

0,01

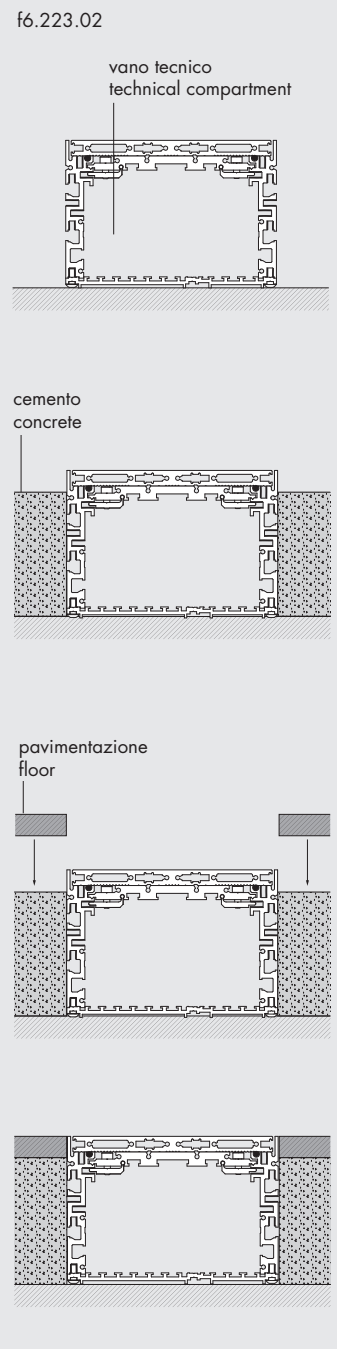

f6.223.01

vano tecnico
technical compartment

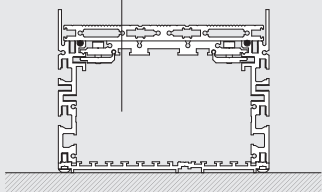

cemento
concrete

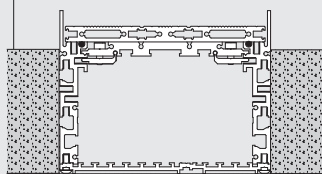

pavimentazione
floor

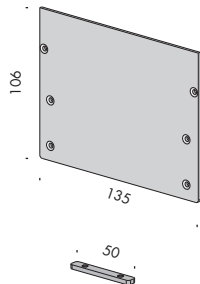
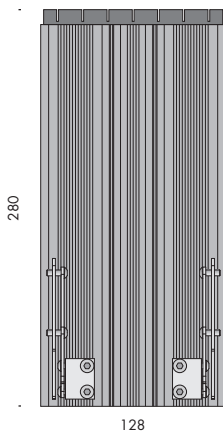
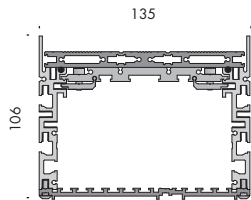
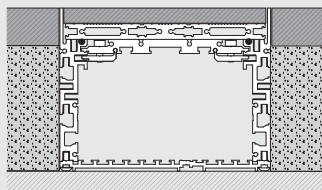
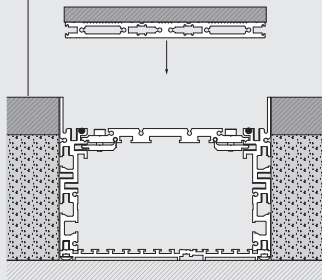

aituoipiedi centrale 106



f6.223.01 nero55
completo di coperchio · lid included

3000mm 22,4

accessori. accessories.



f6.223.41 sportello di accesso al vano tecnico
technical compartment door

280mm 1,1

f6.223.17 testata di chiusura · end plate

0,3

f9.223.80 giunti lineari · linear joints

4 pz · pcs 0,01



f6.223.03

vano tecnico
technical compartment

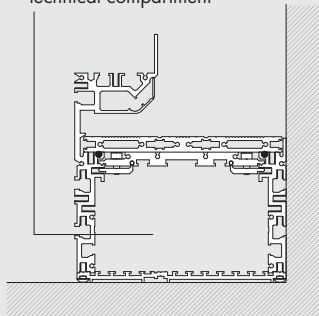

cemento
concrete

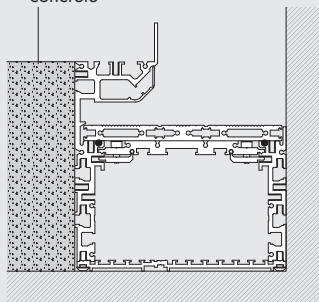

pavimentazione
floor

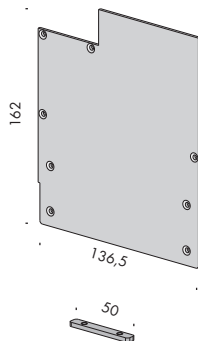
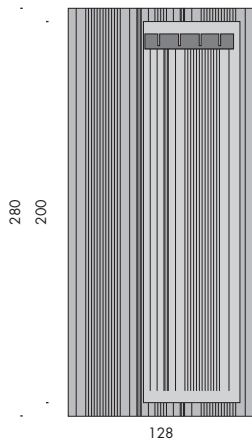
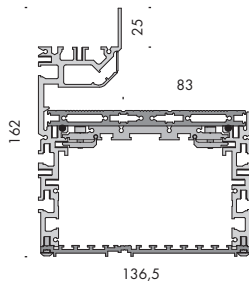
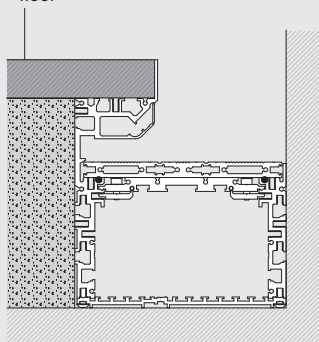

aituoipiedi perimetrale 162



f6.223.03 nero55
completo di coperchio · lid included

3000mm 25,8

accessori. accessories.



f6.223.42 sportello di accesso al vano tecnico
technical compartment door

280mm 1,1

f6.223.19 testata di chiusura · end plate

0,3

f9.223.80 giunti lineari · linear joints

4 pz · pcs 0,01

possibilità di variazione altezza
possibility of height variation

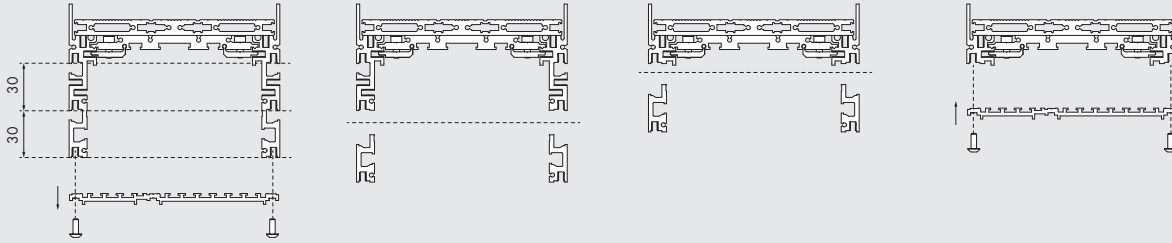

f6.223.01
f6.223.02
variazione altezza aiuoiopiedi centrale
height variation

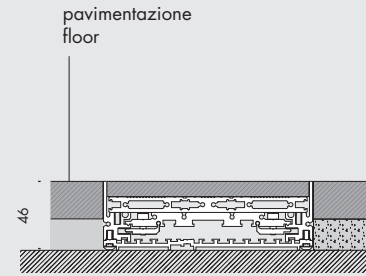
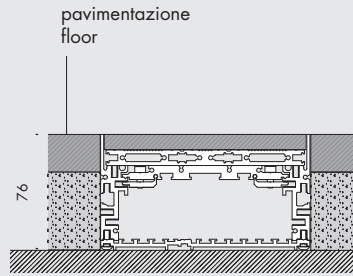
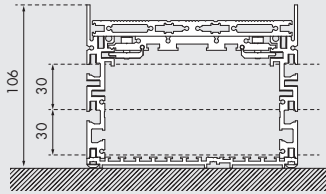

f6.223.03
variazione altezza aiuoiopiedi perimetrale
height variation

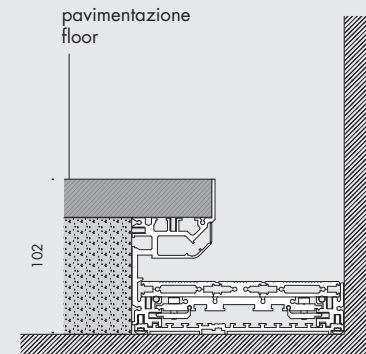
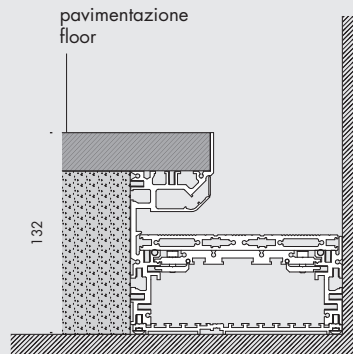
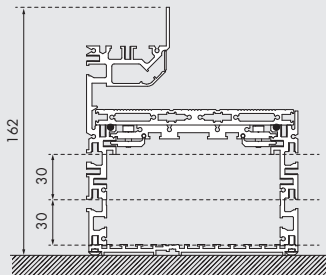

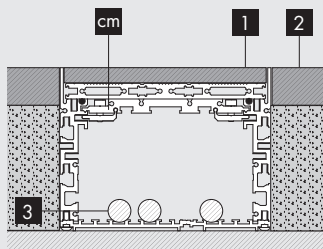

cm f6.223.01 aiutoipiedi centrale 106

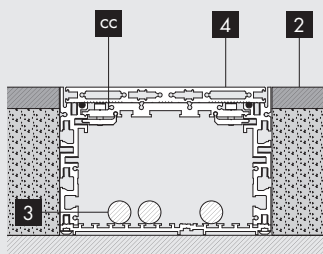

cc f6.223.02 aiutoipiedi centrale 96

1 coperchio in alluminio o sportello di accesso al vano elettrico con finitura del pavimento (spessore max 10mm)
aluminium lid or electric compartment door with finish floor
(max 10mm thickness)

2 pavimentazione
floor

3 cavi elettrici
electric cables

4 coperchio in alluminio o sportello di accesso al vano elettrico
aluminium lid or electric compartment door

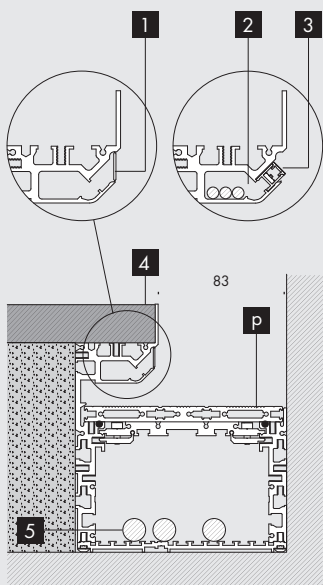

p f6.223.03 aiutoipiedi perimetrale 162

1 linguetta removibile per alloggiare 13x8
removable flap to house 13x8

2 gola per passaggio cavi profilo 13x8
conduit for 13x8 profile cables

3 13x8

4 pavimentazione (max 25mm di spessore)
floor (max 25mm thickness)

6 cavi elettrici
electric cables

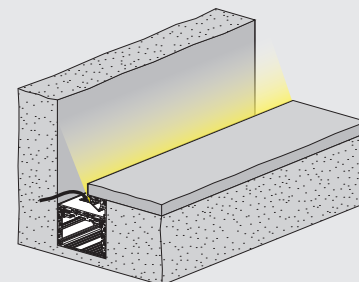
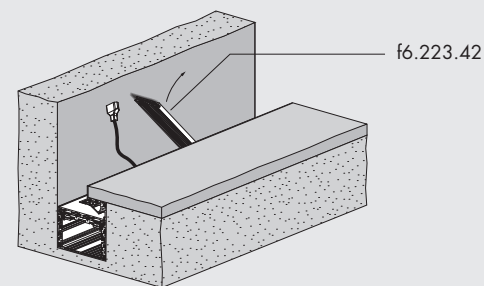
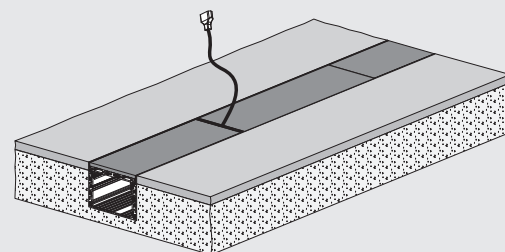
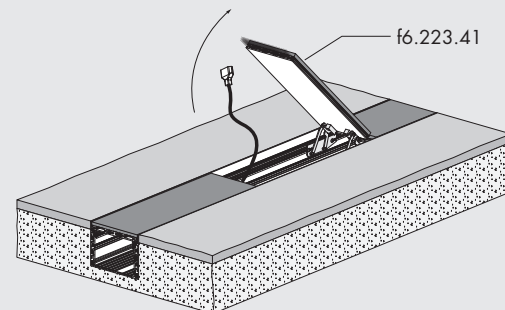



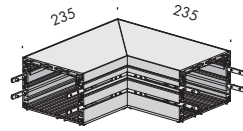

raccordi centrali 96. central 96 couplers.

★ C€ ⓘ

f6.223.32 raccordo L con coperchio a filo
L coupler with flush lid

nero55 2,2

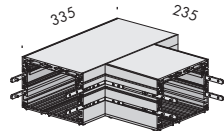

f6.223.33 raccordo T con coperchio a filo
T coupler with flush lid

nero55 2,4

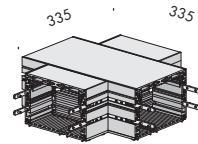

f6.223.34 raccordo + con coperchio a filo
+ coupler with flush lid

nero55 2,4

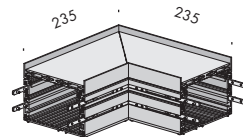

raccordi centrali 106. central 106 couplers.

★ C€ ⓘ

f6.223.21 raccordo L con coperchio ribassato
L coupler with low lid

nero55 2,2

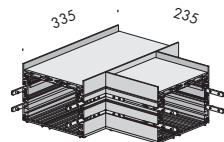

f6.223.22 raccordo T con coperchio ribassato
T coupler with low lid

nero55 2,4

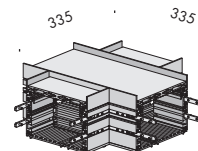

f6.223.23 raccordo + con coperchio ribassato
+ coupler with low lid

nero55 2,4

raccordi perimetrali 162. perimeter 162 couplers.

☆ CE ⓘ

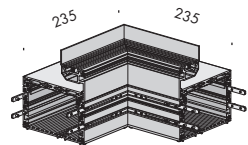

f6.223.27 raccordo angolo interno L
inside corner L coupler

nero55 2,9

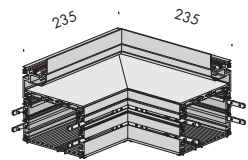

f6.223.28 raccordo angolo esterno L
outside corner L coupler

nero55 3,9



raccordi perimetrali 162/centrali 106. perimeter 162/central 106 couplers. ☆ CE i

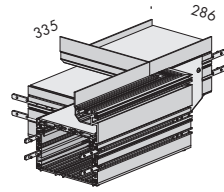

f6.223.29 raccordo dx T con coperchio ribassato
right T coupler with low lid nero55 3,1

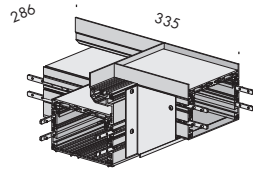

f6.223.30 raccordo sx T con coperchio ribassato
left T coupler with low lid nero55 3,1

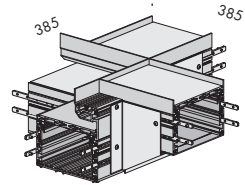

f6.223.31 raccordo + con coperchio ribassato
+ coupler with low lid nero55 3,8

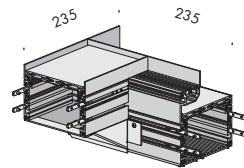

f6.223.24 raccordo dx L con coperchio ribassato
right L coupler with low lid nero55 3,1

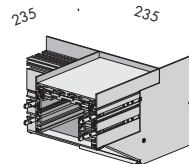

f6.223.25 raccordo sx L con coperchio ribassato
left L coupler with low lid nero55 3,1

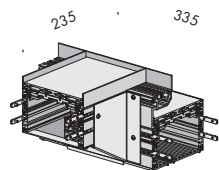

f6.223.26 raccordo T con coperchio ribassato
T coupler with low lid nero55 3,8



Acqua da sera
Pompa di vetro
Finita in oro e cristallo
prodotto in Italia 2004

Tramonto
oro e cristallo, montato sulla base
spring summer 2004

Acqua da sera
Pompa di vetro
Finita in oro e cristallo
prodotto in Italia 2004

Tramonto
oro e cristallo, montato sulla base
spring summer 2004

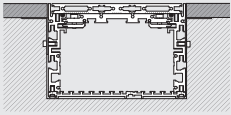

cc f6.223.02
aituoipiedi centrale 96

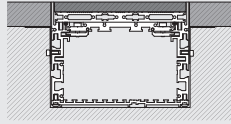

cm f6.223.01
aituoipiedi centrale 106

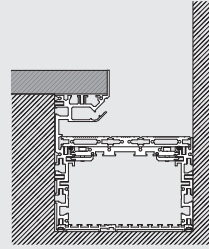

p f6.223.03
aituoipiedi perimetrale 162

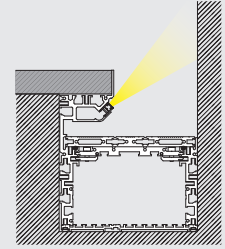

pl f6.223.03 + 13x8
aituoipiedi perimetrale 162

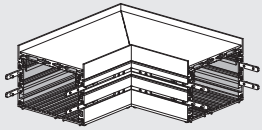

1 f6.223.21

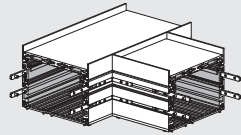

2 f6.223.22

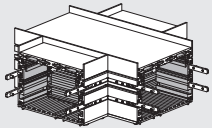

3 f6.223.23

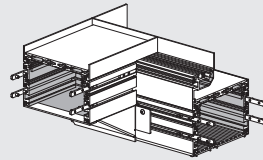

4 f6.223.24

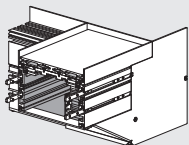

5 f6.223.25

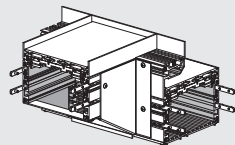

6 f6.223.26

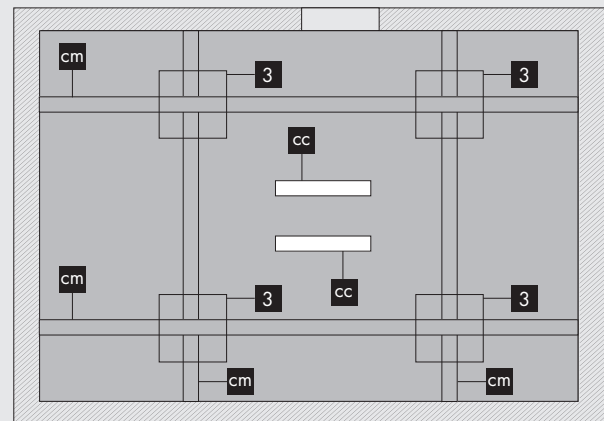
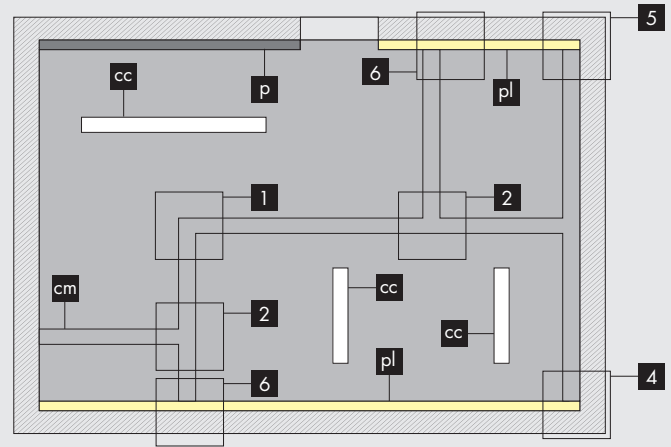



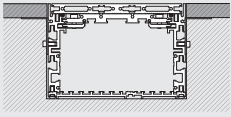

cc f6.223.02
aituoipiedi centrale 96

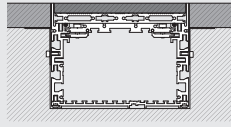

cm f6.223.01
aituoipiedi centrale 106

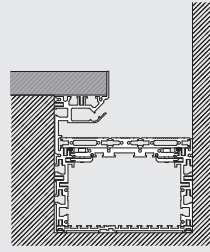

p f6.223.03
aituoipiedi perimetrale 162

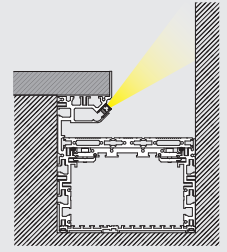

pl f6.223.03 + 13x8
aituoipiedi perimetrale 162

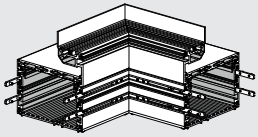

7 f6.223.27

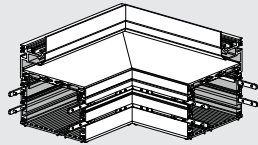

8 f6.223.28

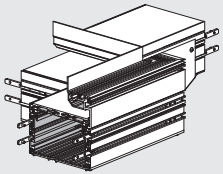

9 f6.223.29

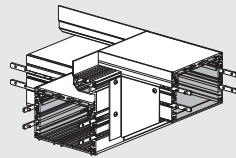

10 f6.223.39

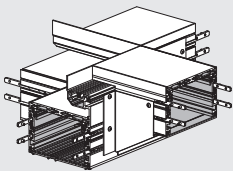

11 f6.223.40

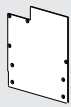

12 f6.223.19

