

Viabizzuno strada principale della frazione di bizzuno in provincia di ravenna dove tra la casa del popolo e la parrocchia, al n°17, sono nato il ventuno luglio millenovecentocinquantacinque. da qui nasce il nome della fabbrica di produzione fondata nel millenovecentonovantaquattro rappresentata da uno spazio bianco attraversato da due linee. una verticale, rigorosa, essenziale, equilibrata: la luce per la luce; ed una inclinata, irriverente nello spazio, ironica, fuori dagli schemi: la luce per la forma. distinte ma complementari si fondono in un unico nome: Viabizzuno.

Viabizzuno is the name of the main road of the small village bizzuno located in the province of ravenna, where I was born on the twenty-first july nineteenfiftyfive at n°17, between the 'casa del popolo' and the local parish church. from here the name of the factory founded in nineteen ninety-four represented by a white space intersected by two lines. one vertical, well balanced, logical, essential: the light for the light. the other one dynamic, irreverent, ironic: the light for the form. separate and yet complementary they cast in the same name: Viabizzuno. marionanni

*i progetti rendono gli oggetti eterni,
le mode li corrompono, gli imbecilli li copiano
e li vendono agli ignoranti e ai deficienti.
noi progettiamo e lavoriamo per aiutare la luce
ad emozionarvi.*

*i frutti delle nostre idee e dei nostri progetti
sono protetti da brevetti
e/o modelli registrati
e/o da diritto d'autore.*

design makes objects timeless,
fashion corrupts them,
fools copy them and sell them to
ignorants and idiots.
we do projects and work to help light to bring
you true emotion.
the results of our ideas and our projects
are protected by patents
and/or registered models
and/or copyright.

al fine di offrire ai nostri clienti la massima qualità della luce utilizzando le più avanzate tecnologie, forti del nostro sapere artigiano costruito in italia, aggiorniamo costantemente i nostri apparecchi di illuminazione.

Viabizzuno si riserva il diritto di apportare ai propri modelli, senza nessun preavviso, qualsiasi modifica ritenesse opportuna. per dimensioni e codici fanno fede i nostri strumenti di lavoro www.Viabizzuno.com, Viacommerce@, Viabizzunoapplight e Viabizzunoonline.

in order to provide to our customers the maximum quality of light using the most advanced technologies, being strong of our artisan knowledge made in italy, we constantly update our lighting fixtures.

Viabizzuno reserves the right to make any modification, considered worthwhile, to its own models, without any notification. for valid dimensions and codes please consult our working tools www.Viabizzuno.com, Viacommerce@, Viabizzunoapplight and Viabizzunoonline.

lettura delle tabelle tecniche how to read technical tables

XXXXXXXXXXXXXXXXXX										
230V 50-60Hz				A	⊕	IP66			CE	
a	b	c	d	e	f	g	g	h	i	

XXXXXXXXXXXXXXXXXX										
230V 50-60Hz				A	⊕	IP66			CE	
Vbx.xxx.xx	nero55	3000K		35W	1,5					
l	m	n	o	i						

componenti. components.	IK10	CE	
--------------------------------	------	----	--

accessori. accessories.	IK10	CE	
--------------------------------	------	----	--

1	2	3	4	5	6	7	8	9	10
---	---	---	---	---	---	---	---	---	----

Ra	R9	ies tm/30		sdcM	Vf	lm/m	W/m	lm/W	
95	90	Rf 90	Rg 98	step 2	24	1200	13	92	F
V0000	5,9	Ta25 °C		vita media · average life	50000 h	L80	B10		

11	12	13	14
----	----	----	----

bandella tecnica. posizioni standard simbologie.
data plate. standard arrangement of symbols.

a	nome apparecchio di illuminazione · light fitting name
b	tensione di alimentazione · supply rating (Volt)
c	frequenza di alimentazione · supply frequency (Hertz)
d	alimentatore incluso o escluso · power supply included or not included
e	classe di isolamento · insulation class
f	grado di protezione · protection degree
g	marchio di certificazione · safety and quality standards certification
h	conforme alle direttive europee produced in compliance with EC directives
i	peso netto · net weight (kg)
l	codice · code
m	finitura · finish
n	temperatura colore sorgente elettronica colour temperature led source (Kelvin)
o	potenza della sorgente · source power (Watt)

componenti. identifica tutti gli elementi indispensabili per la corretta funzionalità e installazione dell'apparecchio di illuminazione.
components. includes all items that are essential to the correct operation and installation of the light fitting.















accessori. si riferisce alle ulteriori parti installabili sull'apparecchio.
accessories. refers to items that can be added to the light fitting.

1	indice di resa cromatica · colour rendering index
2	indice di resa del rosso · red colour rendering index
3	Rf indice di fedeltà colore · colour fidelity index Rg indice di saturazione colore · color gamut index
4	step di macadam · macadam step
5	corrente di alimentazione · power supply current
6	tensione di alimentazione · power supply voltage
7	flusso luminoso · light flux
8	potenza della sorgente · source power
9	efficienza della sorgente · source efficiency
10	classe di efficienza energetica · efficiency class
11	codice sorgente elettronica Viabizzuno · Viabizzuno led source code
12	superficie emittente · light emitting surface (mm)
13	% flusso residuo a fine vita · end life % flux
14	% consentita sotto limite · allowed % under limit

gradi di protezione protection degrees

IP0X	<i>non protetto</i> no protection	IPX0	<i>non protetto</i> no protection		
IP1X	<i>contro corpi estranei >50 mm</i> protection against solid objects	IPX1	<i>protetto contro la caduta verticale di gocce d'acqua</i> protected against water drops falling vertically	IK01	<i>nessuna protezione</i> no protection
IP2X	<i>contro corpi estranei >12 mm</i> protection against solid objects	IPX2	<i>protetto contro la caduta di gocce con inclinazione max 15°</i> protected against water drops max inclination 15°	IK01	<i>protetto contro l'energia d'urto 0,15J</i> protected against collision energy
IP3X	<i>contro corpi estranei >2,5 mm</i> protection against solid objects	IPX3	<i>protetto contro la caduta di gocce con inclinazione max 60°</i> protected against water drops max inclination 60°	IK02	<i>protetto contro l'energia d'urto 0,2J</i> protected against collision energy
IP4X	<i>contro corpi estranei >1 mm</i> protection against solid objects	IPX4	<i>protetto contro spruzzi d'acqua</i> protected against sprinkling water	IK03	<i>protetto contro l'energia d'urto 0,35J</i> protected against collision energy
IP5X	<i>protezione da polvere</i> dust-protected	IPX5	<i>protetto contro getti d'acqua</i> protected against water jets	IK04	<i>protetto contro l'energia d'urto 0,5J</i> protected against collision energy
IP6X	<i>stagno alla polvere</i> dust-proof	IPX6	<i>protetto contro inondazioni</i> protected against flooding	IK05	<i>protetto contro l'energia d'urto 0,7J</i> protected against collision energy
		IPX7	<i>per breve immersione</i> protected against brief immersions	IK06	<i>protetto contro l'energia d'urto 1J</i> protected against collision energy
		IPX8	<i>per immersione prolungata</i> protected against long immersion	IK07	<i>protetto contro l'energia d'urto 2J</i> protected against collision energy
				IK08	<i>protetto contro l'energia d'urto 5J</i> protected against collision energy
				IK09	<i>protetto contro l'energia d'urto 10J</i> protected against collision energy
				IK10	<i>protetto contro l'energia d'urto 20J</i> protected against collision energy

legenda simboli symbols key

-  tavolo · table
-  terra · floor standing
-  soffitto · ceiling
-  parete · wall
-  sospensione · suspension
-  binario · track
-  incasso · recessed
-  scomparsa totale · fully concealed
-  segnaletica+emergenza · signalling system+emergency
-  portatili autoalimentati a batteria · portable self-powered with battery
-  sistemi · systems
-  palo · pole
-  paletto · bollard
-  seduta · sitting

 disponibile su · available on *Viabizzuno applight* www.Viabizzuno.com *Viabizzuno online*

 classe I. solo isolamento fondamentale, le parti conduttrici accessibili sono collegate ad un conduttore di terra. messa a terra tassativa
class I. only basic insulation, accessible conductors are earthed. earthing compulsory

 classe II. all'isolamento principale è aggiunto un secondo isolamento oppure ai due isolamenti è sostituito un isolamento rinforzato. messa a terra esclusa
class II. basic insulation plus second insulation or both are replaced by reinforced insulation. earthing excluded

 classe III. alimentazione effettuata con bassissima tensione di sicurezza; sono escluse tensioni superiori a 50V-50Hz. messa a terra non prevista.
class III. very low safety supply tension; not to be used over 50V-50Hz. earthing excluded.

 prodotto conforme alle direttive europee · produced in compliance with ec directives

 marchio di certificazione europea. certifica che il prodotto è conforme alle norme europee sulla sicurezza
component approved for north american market and suitable to be used and approved as part of a more complex system

 componente certificato per il mercato nord americano idoneo ad essere utilizzato e valutato come parte di in un sistema più complesso
component approved for north american market and suitable to be used and approved as part of a more complex system

 apparecchio di illuminazione approvato da kema · kema approved light fitting

 prodotto conforme agli standard presenti nel regno unito che regolamentano la sicurezza e la qualità dell'acqua · product complies with uk standards set out by water regulations

 apparecchio di illuminazione certificato secondo le normative vigenti in polonia che regolamentano i dispositivi di sicurezza antincendio
certified light fitting according to the regulations about devices for fire safety in force in poland

 prodotto idoneo per essere commercializzato nel mercato cinese · product suitable for the china market

 prodotto finito idoneo per essere commercializzato nel mercato nord americano · listed product suitable for the north american market

 apparecchio di illuminazione certificato per il mercato cinese
light fitting certified for china market

-  *vetro opalino* · opal glass
-  *vetro sabbiato* · sanded glass
-  *vetro nero fumè* · black smoke glass
-  *vetro trasparente* · transparent glass
-  *vetro bianco latte* · white milk glass
-  *crystallo* · crystal
-  *policarbonato opalino* · opal polycarbonate diffuser
-  *carrabile* · drive over
-  *alimentatore incluso* · power supply included
-  *alimentatore escluso* · power supply not included
-  *alimentatore remoto incluso* · remote power supply included
-  *alimentatore elettronico con controllo intelligente incluso* · electronic power supply with smart control included
-  *alimentatore elettronico con controllo intelligente incluso, da installare remoto* · electronic power supply with smart control included, to be installed remotely
-  *alimentatore a spina incluso* · plug power supply included
-  *trasformatore incluso* · transformer included
-  *trasformatore escluso* · transformer not included
-  *kit di cablaggio* · wiring kit
-  *kit di cablaggio escluso* · wiring kit not included
-  *lampadina con sorgente elettronica led, ad incandescenza, alogena o fluorescente inclusa.*
bulb with led electronic source, incandescent, halogen or fluorescent included.
-  *lampadina con sorgente elettronica led, ad incandescenza, alogena o fluorescente esclusa.*
bulb with led electronic source, incandescent, halogen or fluorescent not included.
-  *propulsore dinamico n55 incluso* · included
-  *possibilità di combinazione tra interfaccia n55, propulsore dinamico n55 e lampadina n55* · possible combination between n55 interface, propulsore dinamico n55 and n55 bulb
-  *attenzione: sorgente luminosa led. non guardare mai direttamente a occhio nudo* · attention: led light source. never look straight without eye protection
-  *flicker free compatibile con fotocamere digitali* · flicker free digital camera friendly
- l.d.** *luce diretta* · direct light
- l.i.** *luce indiretta* · indirect light
- .d1** *dimmerazione 1-10V* · 1-10V dimmable
- .d2** *dimmerazione dali* · dimmable dali
- .SA** *kit luce + emergenza sempre accese. attenzione: non è possibile installare nelle cassaforme laterizio*
light kit + permanently lit emergency lamp. please note: cannot be installed in brickwork housing
- .SE** *solo emergenza sempre accesa. attenzione: non è possibile installare nelle cassaforme laterizio*
permanently lit emergency lamp only. please note: cannot be installed in brickwork housing
-  *peso netto* · net weight (kg)

n55® parete soffitto orientabile

marionanni 2014



brevettato · patented



apparecchio di illuminazione a parete o soffitto per interni IP20 realizzato in alluminio ossidato.

modelli:

**n55 parete soffitto orientabile con alimentatore escluso, diametro Ø80 con tige h.100mm,
n55 parete soffitto scomparsa totale orientabile con alimentatore escluso, con tige h.100mm.
in tutte le versioni la tige è di diametro Ø10mm con interfaccia orientabile di diametro Ø55mm.**

da abbinare ai seguenti propulsori dinamici n55:

55/350e les19 9,7W 350mA 1240lm,

55/350 les19 9,7W 350mA 1240lm,

55/500 les19 14W 500mA 1580lm,

55/500 les9 13,6W 500mA 800lm,

65/500e les19 14W 500mA 1580lm,

65/700 les19 19,9W 700mA 2140lm,

65/700 les9 19,5W 700mA 1110lm,

82/1050 les19 30,5W 1050mA 3000lm.

tutti i propulsori sono Ra98 1 step macadam con sorgente elettronica 2700K, 3000K o 3000Vb K (progettato per il settore alta moda).

l'apposito attacco n55 permette di intercambiare tre tipi di lampadina: classica, decorativa e tecnica.

eventuali irregolarità del vetro sono garanzia di un prodotto unico, soffiato e realizzato interamente a mano da maestri vetrai.

alimentatore escluso, da installare remoto o all'interno della cassaforma.

accessori: cassaforma scomparsa totale per cartongesso e laterizio, tappi di chiusura, guarnizione con trappola di luce per vetri trasparenti; frangiluce a nido d'ape, lente ellittica, antiabbagliamento per lampadine tecniche.

finiture: argento hacca, nero55, my bianco.

lampadine classiche e decorative con vetro trasparente, sabbato e bianco latte.

personalizza la tua luce vai su www.Viabizzuno.com

IP20 rated wall or ceiling light fitting for indoor use made of oxidised aluminium.

versions:

n55 parete soffitto orientabile with power supply not included, Ø80 with h.100mm rod,

**n55 parete soffitto scomparsa totale orientabile with power supply not included,
with h.100mm rod;**

in all versions the rod has a 10mm diameter with a Ø55mm adjustable interface.

which can be paired with the following propulsori dinamici n55:

55/350e les19 9.7W 350mA 1240lm,

55/350 les19 9.7W 350mA 1240lm,

55/500 les19 14W 500mA 1580lm,

55/500 les9 13.6W 500mA 800lm,

65/500e les19 14W 500mA 1580lm,

65/700 les19 19.9W 700mA 2140lm,

65/700 les9 19.5W 700mA 1110lm,

82/1050 les19 30.5W 1050mA 3000lm.

all propellers are Ra98 1 step macadam with 2700K, 3000K or 3000Vb K electronic source (designed for high fashion industry).

the specific n55 lamp-holder allows to change three types of light bulbs: classic, decorative and technical. any irregularities in the glass are a guarantee of an unique product, blown and entirely hand crafted by master glassmakers.

power supply not included, to be installed remotely or within the housing.

accessories: fully concealed housing for plasterboard and brickwork, end caps, gasket with light trap for transparent glass; honeycomb louvre, elliptical lens and anti-glare for technical bulbs.

finishes: argento hacca, nero55, my bianco.

classic and decorative bulbs with transparent, sanded and milk white glass.

customize your light visit www.Viabizzuno.com



personalizza la tua luce
vai su Viabizzuno.com



+



+



diffusore decorativo
decorative diffuser



diffusore tecnico
technical diffuser

1. scegli l'interfaccia
choose the interface

2. scegli il propulsore dinamico n55
choose the propulsore dinamico n55

3. scegli il tuo diffusore classico, decorativo e tecnico
choose your classic, decorative and technical diffuser

**n55 parete soffitto orientabile a.r. †
interfaccia**

alimentatore incassato
recessed power supply



**n55 parete soffitto orientabile a.r. †
interfaccia**

alimentatore remoto
remote power supply

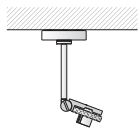

**n55 parete soffitto orientabile a.r. †
interfaccia**

alimentatore remoto con rosone scomparsa totale
remote power supply with fully concealed rose

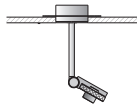

55/350e †



les19 ●
350mA
1240 lm
9,7W
128 lm/W

55/350 †



les19 ●
350mA
1240 lm
9,7W
128 lm/W

55/500 †



les19 ●
500mA
1580 lm
14W
113 lm/W

55/500 †



les9 ●
500mA
800 lm
13,6W
59 lm/W

65/500e †



les19 ●
500mA
1580 lm
14W
113 lm/W

65/700 †



les19 ●
700mA
2140 lm
19,9W
108 lm/W

65/700 †



les9 ●
700mA
1110 lm
19,5W
57 lm/W

82/1050 †



les19 ●
1050mA
3000lm
30,5W
98 lm/W

hm01 †



hm02 †



**diffusore decorativo
decorative diffusor**

**diffusore tecnico
technical diffusor**

mn01 ↓

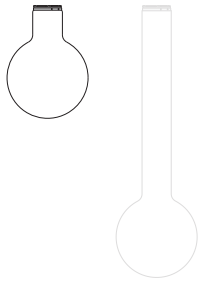

mn07 ↓ **dc01** ↓

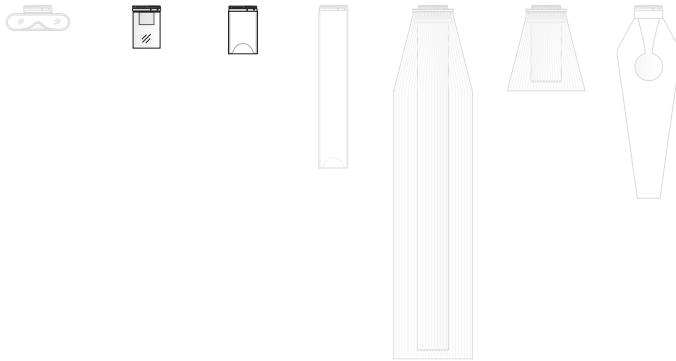

pz03 ↓



kk01 ↓

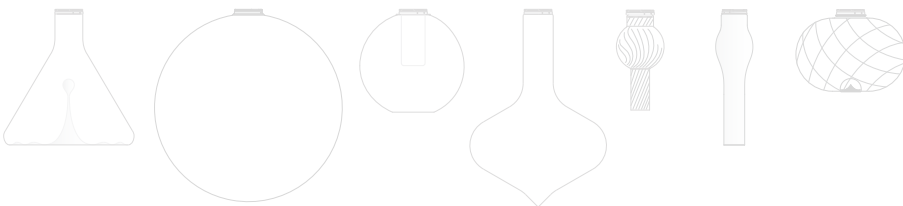
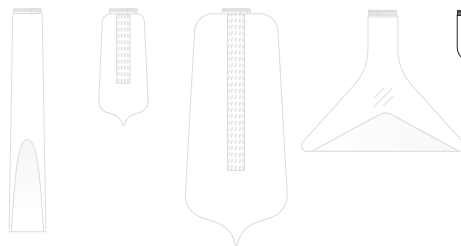

aip01 ↓

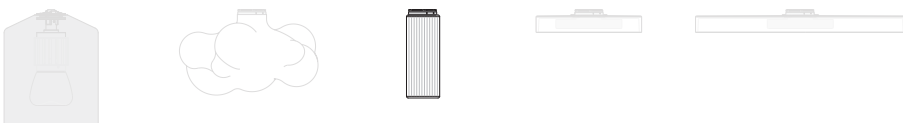

spot35 ↓



les19 ●

les9 ●

spot55x37 ↓



30° 38°

18° 23° 36°

spot55x61 ↓



36° 47°

spot82x35 ↓



les19 ●

les9 ●

31° 42°

13° 19° 23° 35°

spot82x79 ↓



23° 37° 46°

spot100 ↓



les19 ●

les9 ●

16° 25° 40° 54°

10° 22°

lensoptica amP150 ↓



les19 ●

les9 ●

22° 51°

13°

lensoptica amP180 ↓



les19 ●

les9 ●

15° 41° 53° 20°x55°

10°



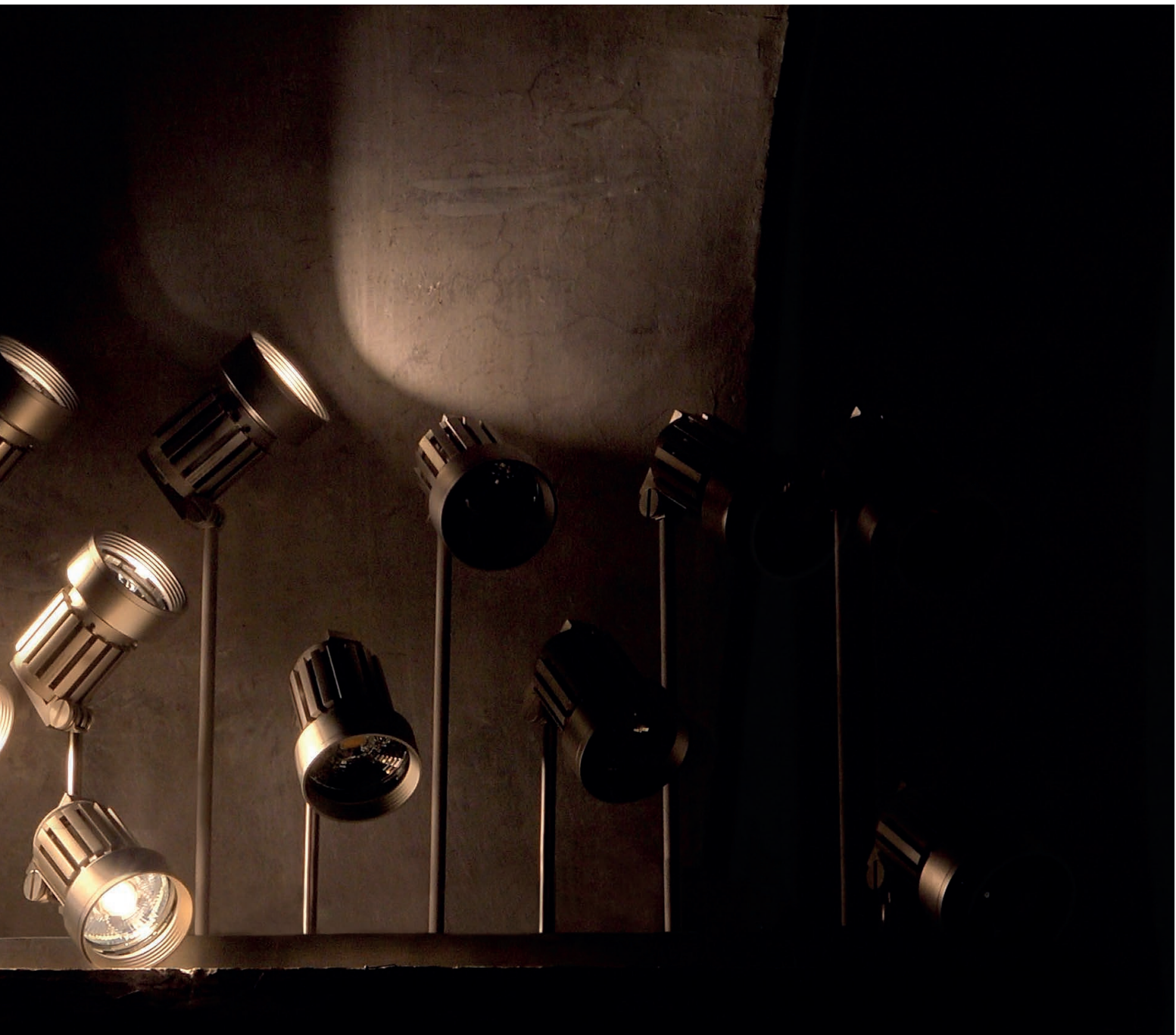

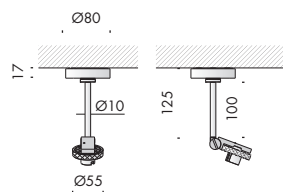

n55 parete soffitto orientabile interfaccia



Vb6.580.13	argento hacca	n55	0,5
Vb6.580.14	nero55	n55	0,5
Vb6.580.15	my bianco	n55	0,5

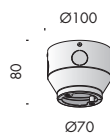

accessori. accessories.

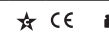

Vb9.580.70	cassaforma laterizio per alimentatore brick housing for power supply		0,2
-------------------	---	--	-----

montaggio rosone con cassaforma laterizio per alimentatore
ceiling rose mounting with brick housing for power supply

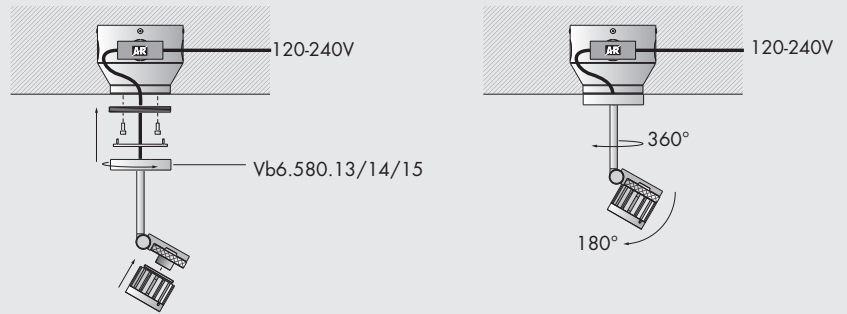

montaggio rosone con alimentatore remoto
ceiling rose mounting with remote power supply

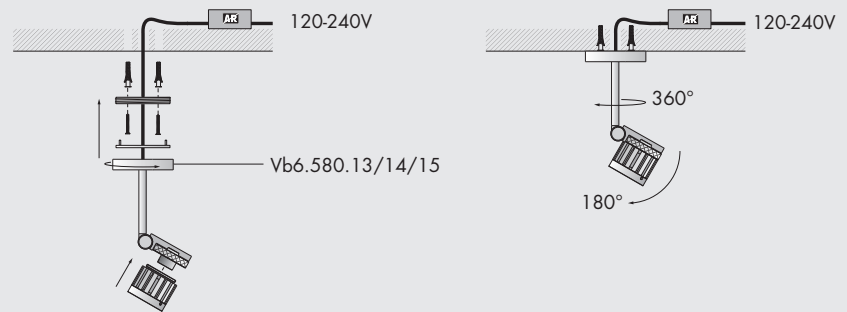

montaggio cassaforma scomparsa totale per cartongesso con alimentatore remoto
fully concealed housing mounting for plasterboard with remote power supply

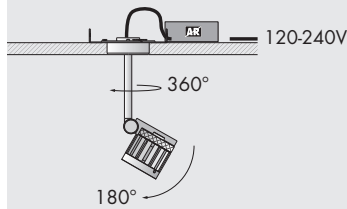
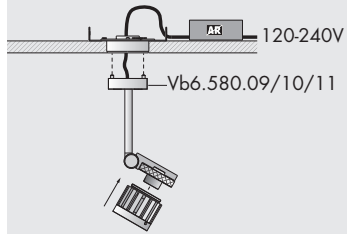

montaggio cassaforma scomparsa totale laterizio per alimentatore
fully concealed housing mounting with brick housing with power supply

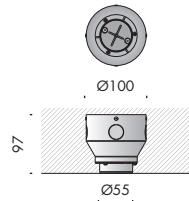
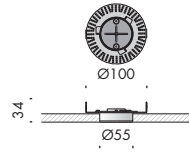
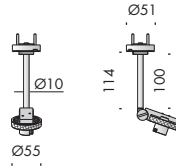
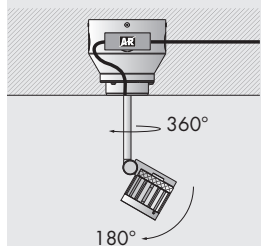
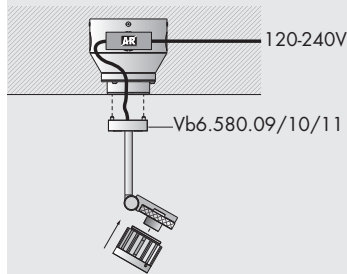

n55 parete soffitto orientabile interfaccia scomparsa totale

Vb6.580.09	argento hacca	n55	0,5
Vb6.580.10	nero55	n55	0,5
Vb6.580.11	my bianco	n55	0,5

rosone di alimentazione. ceiling roses.

Vb9.580.73	cassaforma cartongesso scomparsa totale plasterboard housing total recessed		0,2
-------------------	--	--	-----

Vb9.580.74	cassaforma laterizio scomparsa totale brick housing total recessed		0,2
-------------------	---	--	-----

accessori scomparsa totale. fully concealed accessories.

Vb9.580.83	tappo di chiusura · end cap	argento hacca	0,1
Vb9.580.84	tappo di chiusura · end cap	nero55	0,1
Vb9.580.85	tappo di chiusura · end cap	my bianco	0,1









propulsore dinamico n55 55/350e



Vb9.580.150.27	argento hacca	2700K	les19 ●	n55	0,2
Vb9.580.151.27	nero55	2700K	les19 ●	n55	0,2
Vb9.580.152.27	my bianco	2700K	les19 ●	n55	0,2

Ra	R9	ies tm-30		sdc	mA	V _{f (min)}	lm	W	lm/W
98	98	Rf 96	Rg 103	step 1	350	27,6	1240	9,7	128
xm000	les19 ●	Ta25 °C		vita media · average life		70000 h	L80 B10		





Vb9.580.150.30	argento hacca	3000K	les19 ●	n55	0,2
Vb9.580.151.30	nero55	3000K	les19 ●	n55	0,2
Vb9.580.152.30	my bianco	3000K	les19 ●	n55	0,2

Ra	R9	ies tm-30		sdc	mA	V _{f (min)}	lm	W	lm/W
98	98	Rf 96	Rg 103	step 1	350	27,6	1240	9,7	128
xm001	les19 ●	Ta25 °C		vita media · average life		70000 h	L80 B10		

Vb9.580.150.30v	argento hacca	3000VbK	les19 ●	n55	0,2
Vb9.580.151.30v	nero55	3000VbK	les19 ●	n55	0,2
Vb9.580.152.30v	my bianco	3000VbK	les19 ●	n55	0,2

Ra	R9	ies tm-30		sdc	mA	V _{f (min)}	lm	W	lm/W
98	98	Rf 93	Rg 106	step 1	350	27,6	1240	9,7	128
xm007	les19 ●	Ta25 °C		vita media · average life		70000 h	L80 B10		



propulsore dinamico n55 55/350   **IP20**   **CE** 

Vb9.580.50.27 argento hacca 2700K les19 ● n55 0,2

Vb9.580.51.27 nero55 2700K les19 ● n55 0,2

Vb9.580.52.27 my bianco 2700K les19 ● n55 0,2

Ra	R9	ies tm-30		sdc	mA	V _{f (min)}	lm	W	lm/W
98	98	Rf 96	Rg 103	step 1	350	27,6	1240	9,7	128
xm000	les19 ●	Ta25 °C		vita media · average life		70000 h	L80 B10		

Vb9.580.50.30 argento hacca 3000K les19 ● n55 0,2

Vb9.580.51.30 nero55 3000K les19 ● n55 0,2

Vb9.580.52.30 my bianco 3000K les19 ● n55 0,2

Ra	R9	ies tm-30		sdc	mA	V _{f (min)}	lm	W	lm/W
98	98	Rf 96	Rg 103	step 1	350	27,6	1240	9,7	128
xm001	les19 ●	Ta25 °C		vita media · average life		70000 h	L80 B10		

Vb9.580.50.30v argento hacca 3000VbK les19 ● n55 0,2

Vb9.580.51.30v nero55 3000VbK les19 ● n55 0,2

Vb9.580.52.30v my bianco 3000VbK les19 ● n55 0,2

Ra	R9	ies tm-30		sdc	mA	V _{f (min)}	lm	W	lm/W
98	98	Rf 93	Rg 106	step 1	350	27,6	1240	9,7	128
xm007	les19 ●	Ta25 °C		vita media · average life		70000 h	L80 B10		



propulsore dinamico n55 55/500 **IP20**

- Vb9.580.62.27** argento hacca 2700K les19 ● n55 0,2
- Vb9.580.63.27** nero55 2700K les19 ● n55 0,2
- Vb9.580.64.27** my bianco 2700K les19 ● n55 0,2

Ra	R9	ies tm-30		sdc	mA	V _{f (min)}	lm	W	lm/W
98	98	Rf 96	Rg 103	step 1	500	27,9	1580	14,0	113
xm000	les19 ●	Ta25 °C		vita media · average life		70000 h	L80 B10		





- Vb9.580.62.30** argento hacca 3000K les19 ● n55 0,2
- Vb9.580.63.30** nero55 3000K les19 ● n55 0,2
- Vb9.580.64.30** my bianco 3000K les19 ● n55 0,2

Ra	R9	ies tm-30		sdc	mA	V _{f (min)}	lm	W	lm/W
98	98	Rf 96	Rg 103	step 1	500	27,9	1580	14,0	113
xm001	les19 ●	Ta25 °C		vita media · average life		70000 h	L80 B10		

- Vb9.580.62.30v** argento hacca 3000VbK les19 ● n55 0,2
- Vb9.580.63.30v** nero55 3000VbK les19 ● n55 0,2
- Vb9.580.64.30v** my bianco 3000VbK les19 ● n55 0,2

Ra	R9	ies tm-30		sdc	mA	V _{f (min)}	lm	W	lm/W
98	98	Rf 93	Rg 106	step 1	500	27,9	1580	14,0	113
xm007	les19 ●	Ta25 °C		vita media · average life		70000 h	L80 B10		



propulsore dinamico n55 55/500   **IP20**   **CE** 

Vb9.580.101.27	argento hacca	2700K	les9 ●	n55	0,2
Vb9.580.102.27	nero55	2700K	les9 ●	n55	0,2
Vb9.580.103.27	my bianco	2700K	les9 ●	n55	0,2

Ra	R9	ies tm-30		sdc	mA	V _{f (min)}	lm	W	lm/W
98	98	Rf 96	Rg 103	step 1	500	27,1	800	13,6	59
xe000	les9 ●	Ta25 °C		vita media · average life		70000 h	L80 B10		

Vb9.580.101.30	argento hacca	3000K	les9 ●	n55	0,2
Vb9.580.102.30	nero55	3000K	les9 ●	n55	0,2
Vb9.580.103.30	my bianco	3000K	les9 ●	n55	0,2

Ra	R9	ies tm-30		sdc	mA	V _{f (min)}	lm	W	lm/W
98	98	Rf 96	Rg 103	step 1	500	27,1	800	13,6	59
xe001	les9 ●	Ta25 °C		vita media · average life		70000 h	L80 B10		

Vb9.580.101.30v	argento hacca	3000VbK	les9 ●	n55	0,2
Vb9.580.102.30v	nero55	3000VbK	les9 ●	n55	0,2
Vb9.580.103.30v	my bianco	3000VbK	les9 ●	n55	0,2

Ra	R9	ies tm-30		sdc	mA	V _{f (min)}	lm	W	lm/W
98	98	Rf 93	Rg 106	step 1	500	27,1	800	13,6	59
xe007	les9 ●	Ta25 °C		vita media · average life		70000 h	L80 B10		

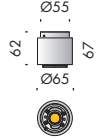

propulsore dinamico n55 65/500e

IP20

- Vb9.580.154.27** argento hacca 2700K les19 ● n55 0,3
- Vb9.580.155.27** nero55 2700K les19 ● n55 0,3
- Vb9.580.156.27** my bianco 2700K les19 ● n55 0,3

Ra	R9	ies tm-30		sdc	mA	V _{f (min)}	lm	W	lm/W
98	98	Rf 96	Rg 103	step 1	500	27,9	1580	14,0	113
xm000	les19 ●	Ta25 °C		vita media · average life		70000 h	L80 B10		





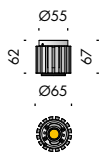

- Vb9.580.154.30** argento hacca 3000K les19 ● n55 0,3
- Vb9.580.155.30** nero55 3000K les19 ● n55 0,3
- Vb9.580.156.30** my bianco 3000K les19 ● n55 0,3

Ra	R9	ies tm-30		sdc	mA	V _{f (min)}	lm	W	lm/W
98	98	Rf 96	Rg 103	step 1	500	27,9	1580	14,0	113
xm001	les19 ●	Ta25 °C		vita media · average life		70000 h	L80 B10		

- Vb9.580.154.30v** argento hacca 3000VbK les19 ● n55 0,3
- Vb9.580.155.30v** nero55 3000VbK les19 ● n55 0,3
- Vb9.580.156.30v** my bianco 3000VbK les19 ● n55 0,3

Ra	R9	ies tm-30		sdc	mA	V _{f (min)}	lm	W	lm/W
98	98	Rf 93	Rg 106	step 1	500	27,9	1580	14,0	113
xm007	les19 ●	Ta25 °C		vita media · average life		70000 h	L80 B10		



propulsore dinamico n55 65/700   **IP20**    

Vb9.580.54.27	argento hacca	2700K	les19 ● n55 0,3
Vb9.580.55.27	nero55	2700K	les19 ● n55 0,3
Vb9.580.56.27	my bianco	2700K	les19 ● n55 0,3

Ra	R9	ies tm-30		sdc	mA	V _{f (min)}	lm	W	lm/W
98	98	Rf 96	Rg 103	step 1	700	28,4	2140	19,9	108
xm000	les19 ●	Ta25 °C		vita media · average life		70000 h	L80 B10		

Vb9.580.54.30	argento hacca	3000K	les19 ● n55 0,3
Vb9.580.55.30	nero55	3000K	les19 ● n55 0,3
Vb9.580.56.30	my bianco	3000K	les19 ● n55 0,3

Ra	R9	ies tm-30		sdc	mA	V _{f (min)}	lm	W	lm/W
98	98	Rf 96	Rg 103	step 1	700	28,4	2140	19,9	108
xm001	les19 ●	Ta25 °C		vita media · average life		70000 h	L80 B10		

Vb9.580.54.30v	argento hacca	3000VbK	les19 ● n55 0,3
Vb9.580.55.30v	nero55	3000VbK	les19 ● n55 0,3
Vb9.580.56.30v	my bianco	3000VbK	les19 ● n55 0,3

Ra	R9	ies tm-30		sdc	mA	V _{f (min)}	lm	W	lm/W
98	98	Rf 93	Rg 106	step 1	700	28,4	2140	19,9	108
xm007	les19 ●	Ta25 °C		vita media · average life		70000 h	L80 B10		



propulsore dinamico n55 65/700

IP20

Vb9.580.106.27	argento hacca	2700K	les9 ●	n55 0,3
Vb9.580.107.27	nero55	2700K	les9 ●	n55 0,3
Vb9.580.108.27	my bianco	2700K	les9 ●	n55 0,3

Ra	R9	ies tm-30		sdc	mA	V _{f (min)}	lm	W	lm/W
98	98	Rf 96	Rg 103	step 1	700	27,9	1110	19,5	57
xe000	les9 ●	Ta25 °C		vita media · average life		70000 h	L80 B10		





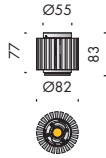

Vb9.580.106.30	argento hacca	3000K	les9 ●	n55 0,3
Vb9.580.107.30	nero55	3000K	les9 ●	n55 0,3
Vb9.580.108.30	my bianco	3000K	les9 ●	n55 0,3

Ra	R9	ies tm-30		sdc	mA	V _{f (min)}	lm	W	lm/W
98	98	Rf 96	Rg 103	step 1	700	27,9	1110	19,5	57
xe001	les9 ●	Ta25 °C		vita media · average life		70000 h	L80 B10		

Vb9.580.106.30v	argento hacca	3000VbK	les9 ●	n55 0,3
Vb9.580.107.30v	nero55	3000VbK	les9 ●	n55 0,3
Vb9.580.108.30v	my bianco	3000VbK	les9 ●	n55 0,3

Ra	R9	ies tm-30		sdc	mA	V _{f (min)}	lm	W	lm/W
98	98	Rf 93	Rg 106	step 1	700	27,9	1110	19,5	57
xe007	les9 ●	Ta25 °C		vita media · average life		70000 h	L80 B10		



propulsore dinamico n55 82/1050   **IP20**    

Vb9.580.58.27	argento hacca	2700K	les19 ●	n55	0,5
Vb9.580.59.27	nero55	2700K	les19 ●	n55	0,5
Vb9.580.60.27	my bianco	2700K	les19 ●	n55	0,5

Ra	R9	ies tm-30		sdc	mA	V _{f (min)}	lm	W	lm/W
98	98	Rf 96	Rg 103	step 1	1050	29,0	3000	30,5	98
xm000	les19 ●	Ta25 °C		vita media · average life			70000 h	L80 B10	

Vb9.580.58.30	argento hacca	3000K	les19 ●	n55	0,5
Vb9.580.59.30	nero55	3000K	les19 ●	n55	0,5
Vb9.580.60.30	my bianco	3000K	les19 ●	n55	0,5

Ra	R9	ies tm-30		sdc	mA	V _{f (min)}	lm	W	lm/W
98	98	Rf 96	Rg 103	step 1	1050	29,0	3000	30,5	98
xm001	les19 ●	Ta25 °C		vita media · average life			70000 h	L80 B10	

Vb9.580.58.30v	argento hacca	3000VbK	les19 ●	n55	0,5
Vb9.580.59.30v	nero55	3000VbK	les19 ●	n55	0,5
Vb9.580.60.30v	my bianco	3000VbK	les19 ●	n55	0,5

Ra	R9	ies tm-30		sdc	mA	V _{f (min)}	lm	W	lm/W
98	98	Rf 93	Rg 106	step 1	1050	29,0	3000	30,5	98
xm007	les19 ●	Ta25 °C		vita media · average life			70000 h	L80 B10	

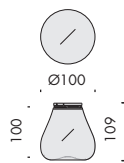
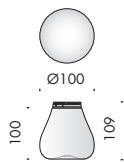
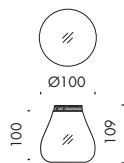
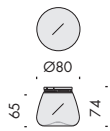
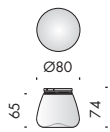
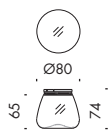
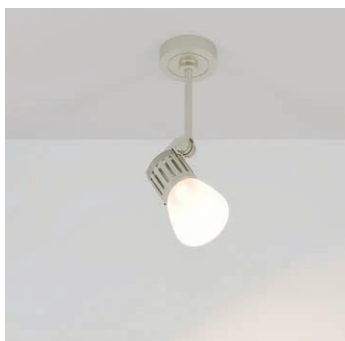

marionanni

★ CE i

Vb9.580.01.t hm01 trasparente · transparent n55 0,05

Vb9.580.01.s hm01 sabbziata · sanded n55 0,05

Vb9.580.01.b hm01 bianco latte · milk white n55 0,05

Vb9.580.02.t hm02 trasparente · transparent n55 0,1

Vb9.580.02.s hm02 sabbziata · sanded n55 0,1

Vb9.580.02.b hm02 bianco latte · milk white n55 0,1



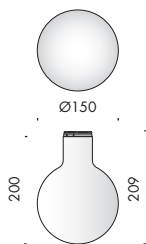
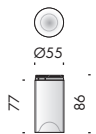

david chipperfield

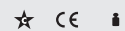

Vb9.580.05.s dc01 sabbaiato · sanded

n55 0,1

marionanni



Vb9.580.03.s mn01 sabbaiato · sanded

n55 0,3

peter zumthor

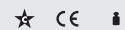

Vb9.580.11.t pz03 trasparente · transparent

n55 0,2

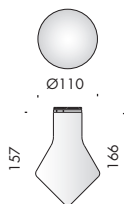
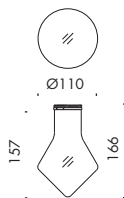

Vb9.580.11.s pz03 sabbaiato · sanded

n55 0,2

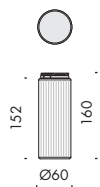

al-jawad pike



Vb9.580.18.tr aip01 trasparente, rigato · transparent, striped n55 0,2



kengo kuma



Vb9.580.07.c kk01 cristallo · crystal n55 0,3



accessori per lampadina trasparente. transparent bulb accessories.



Vb9.580.160 trappola di luce antiabbagliamento nero
anti-glare black light trap 0,03

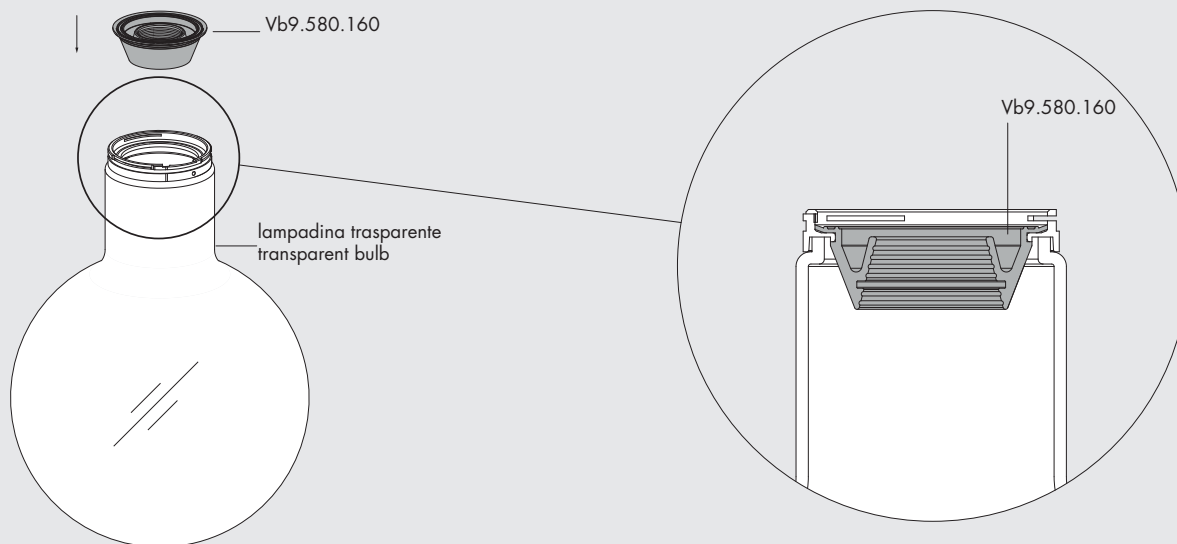

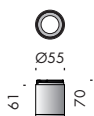
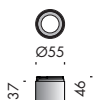
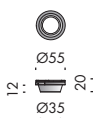

spot35			☆	€	i
Vb9.580.21	argento hacca	87° les19	●	n55	0,1
Vb9.580.22	nero55	87° les19	●	n55	0,1
Vb9.580.22.b	my bianco	87° les19	●	n55	0,1

spot55x37			☆	€	i		
Vb9.580.121	argento hacca	18° les9	●	n55	0,1		
Vb9.580.122	nero55	18° les9	●	n55	0,1		
Vb9.580.122.b	my bianco	18° les9	●	n55	0,1		
Vb9.580.123	argento hacca	23° les9	●	30° les19	●	n55	0,1
Vb9.580.124	nero55	23° les9	●	30° les19	●	n55	0,1
Vb9.580.124.b	my bianco	23° les9	●	30° les19	●	n55	0,1
Vb9.580.125	argento hacca	36° les9	●	38° les19	●	n55	0,1
Vb9.580.126	nero55	36° les9	●	38° les19	●	n55	0,1
Vb9.580.126.b	my bianco	36° les9	●	38° les19	●	n55	0,1

spot55x61			☆	€	i
Vb9.580.25	argento hacca	36° les19	●	n55	0,2
Vb9.580.26	nero55	36° les19	●	n55	0,2
Vb9.580.26.b	my bianco	36° les19	●	n55	0,2
Vb9.580.27	argento hacca	47° les19	●	n55	0,2
Vb9.580.28	nero55	47° les19	●	n55	0,2
Vb9.580.28.b	my bianco	47° les19	●	n55	0,2

accessori. accessories.		☆	€	i
-------------------------	--	---	---	---

Vb9.580.91	frangiluce nido d'ape · honeycomb louvre			0,01
-------------------	--	--	--	------

Vb9.580.92	lente ellittica · elliptical lens			0,04
-------------------	-----------------------------------	--	--	------



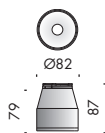

spot82x79

★ CE i

Vb9.580.31	argento hacca	23° les19 ●	n55	0,2
Vb9.580.32	nero55	23° les19 ●	n55	0,2
Vb9.580.32.b	my bianco	23° les19 ●	n55	0,2
Vb9.580.33	argento hacca	37° les19 ●	n55	0,2
Vb9.580.34	nero55	37° les19 ●	n55	0,2
Vb9.580.34.b	my bianco	37° les19 ●	n55	0,2
Vb9.580.35	argento hacca	46° les19 ●	n55	0,2
Vb9.580.36	nero55	46° les19 ●	n55	0,2
Vb9.580.36.b	my bianco	46° les19 ●	n55	0,2

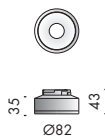

spot82x35

★ CE i

Vb9.580.131	argento hacca	13° les9 ●	n55	0,1
Vb9.580.132	nero55	13° les9 ●	n55	0,1
Vb9.580.137	my bianco	13° les9 ●	n55	0,1
Vb9.580.133	argento hacca	19° les9 ●	n55	0,1
Vb9.580.134	nero55	19° les9 ●	n55	0,1
Vb9.580.138	my bianco	19° les9 ●	n55	0,1
Vb9.580.135	argento hacca	23° les9 ● 31° les19 ●	n55	0,1
Vb9.580.136	nero55	23° les9 ● 31° les19 ●	n55	0,1
Vb9.580.141	my bianco	23° les9 ● 31° les19 ●	n55	0,1
Vb9.580.139	argento hacca	35° les9 ● 42° les19 ●	n55	0,1
Vb9.580.140	nero55	35° les9 ● 42° les19 ●	n55	0,1
Vb9.580.142	my bianco	35° les9 ● 42° les19 ●	n55	0,1

accessori spot82. accessories.

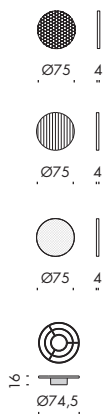

Vb9.580.86	frangiluce nido d'ape · honeycomb louvre	0,01
Vb9.580.87	lente ellittica · elliptical lens	0,05
Vb9.580.88	vetro albarino · albarino glass	0,05
Vb9.580.165	anti abbagliamento · anti-glare	0,03

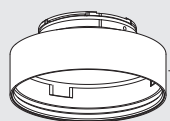

spot82

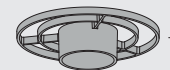

Vb9.580.165



porta accessorio
accessory holder

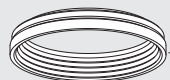

trappola di luce
light trap

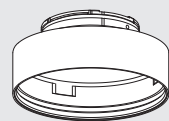

spot82



Vb9.580.88

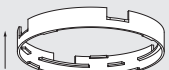

porta accessorio
accessory holder



Vb9.580.165



trappola di luce
light trap

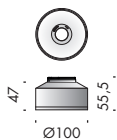

spot100		★	CE	i
Vb9.580.37	argento hacca	10° les9 ●	16° les19 ●	n55 0,1
Vb9.580.38	nero55	10° les9 ●	16° les19 ●	n55 0,1
Vb9.580.38.b	my bianco	10° les9 ●	16° les19 ●	n55 0,1
Vb9.580.39	argento hacca	22° les9 ●	25° les19 ●	n55 0,1
Vb9.580.40	nero55	22° les9 ●	25° les19 ●	n55 0,1
Vb9.580.40.b	my bianco	22° les9 ●	25° les19 ●	n55 0,1
Vb9.580.41	argento hacca		40° les19 ●	n55 0,1
Vb9.580.42	nero55		40° les19 ●	n55 0,1
Vb9.580.42.b	my bianco		40° les19 ●	n55 0,1
Vb9.580.43	argento hacca		54° les19 ●	n55 0,1
Vb9.580.44	nero55		54° les19 ●	n55 0,1
Vb9.580.44.b	my bianco		54° les19 ●	n55 0,1



accessori spot100. accessories.		★	CE	i
Vb9.580.93	frangiluce nido d'ape · honeycomb louvre			0,01
Vb9.580.94	lente ellittica · elliptical lens			0,05



dimensioni gobos in acciaio
steel gobos size

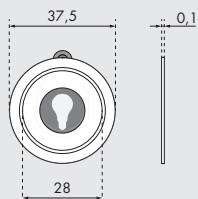

dimensioni gobos in vetro
glass gobos size

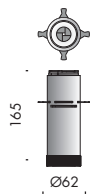
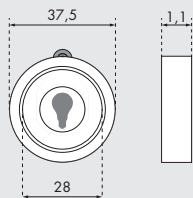

spot sagomatore

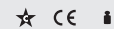

Vb9.580.120 sagomatore · profile spot

les19 ● n55 0,7

accessori. accessories.



Vb9.580.118 gruppo per alloggiamento gobo in vetro
housing for glass gobos 0,01

Vb9.580.119 gruppo per alloggiamento gobo in acciaio
housing for steel gobos 0,1

utilizzabile solo con · use only with
propulsore dinamico les19 ●

propulsore dinamico 82/1050

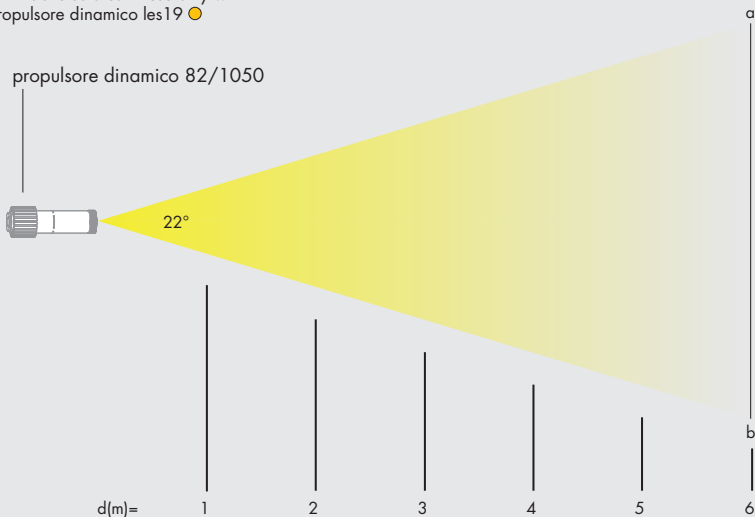

d (m)	ab (m)	e _{max} (lx)	e _{med} (lx)
1	0,38	2761	2273
2	0,76	690	568
3	1,14	307	253
4	1,51	173	142
5	1,89	110	91
6	2,27	77	63

montaggio su propulsore dinamico n55
propeller mounting

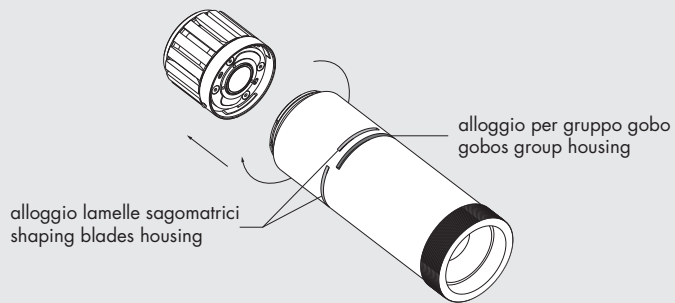

messa a fuoco · focus

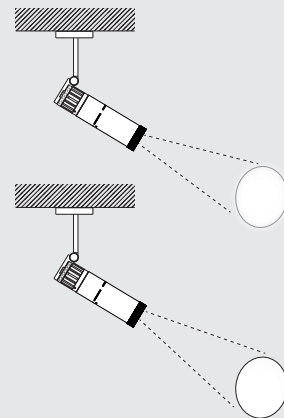
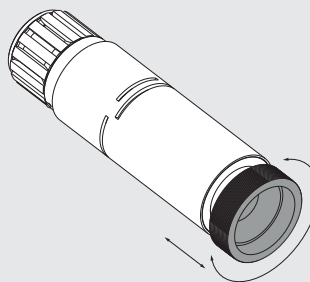

uso delle lamelle sagomatrici · use of shaping blades

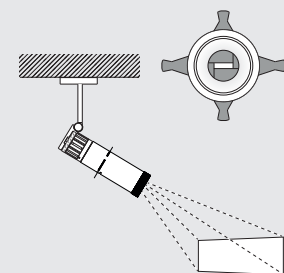
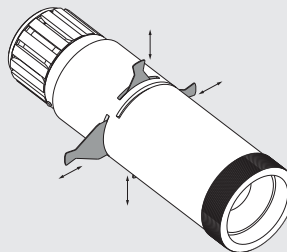
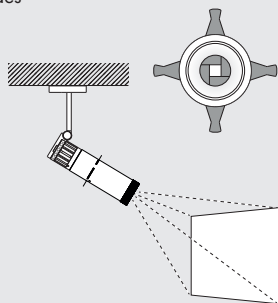
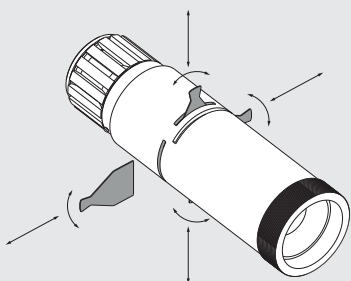

gobo in vetro non incluso
glass gobos not included

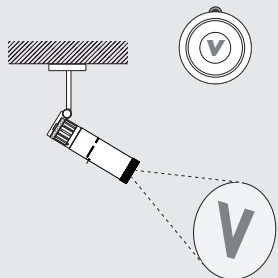
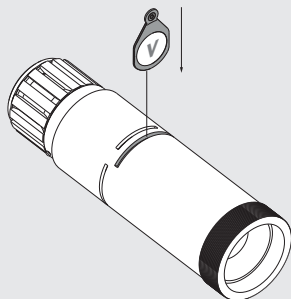

gobo in acciaio non incluso
steel gobos not included

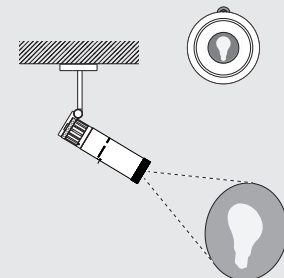
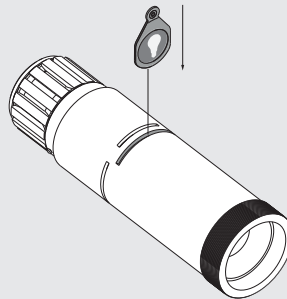

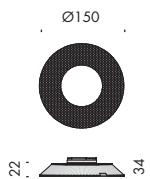

lensoptica amP150

☆ CE i

Vb9.518.91	fascio stretto	13°	les9 ●	n55	0,3
	narrow beam	22°	les19 ●		
Vb9.518.92	fascio largo wide beam	51°	les19 ●	n55	0,3

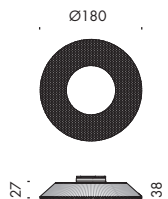

lensoptica amP180

☆ CE i

Vb9.518.81	fascio stretto	10°	les9 ●	n55	0,6
	narrow beam	15°	les19 ●		
Vb9.518.82	fascio medio	41°	les19 ●	n55	0,6
Vb9.518.83	fascio largo	53°	les19 ●	n55	0,6
Vb9.518.84	fascio ellittico	20°x55°	les19 ●	n55	0,6
	elliptical beam				

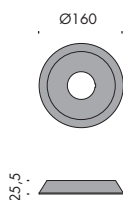

riflettore in metallo 150

☆ CE i

Vb9.518.95.n	nero55				0,1
	my bianco				0,1
Vb9.518.95.h	argento hacca				0,1

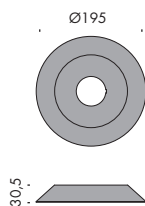

riflettore in metallo 180

☆ CE i

Vb9.518.96.n	nero55				0,1
Vb9.518.96.mb	my bianco				0,1
Vb9.518.96.h	argento hacca				0,1



propulsore dinamico n55

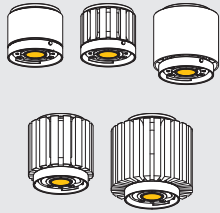

riflettore in metallo - metal reflector

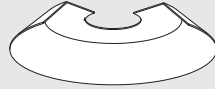

lensoptica amP

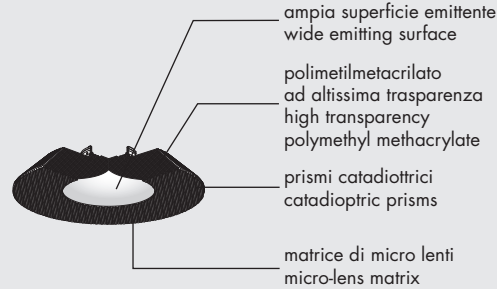

materiale	coefficiente d'assorbimento α
vetro soda calcico	0,017 mm ⁻¹
poli carbonato	0,004 mm ⁻¹
polimetilmetacrilato	0,0014 mm ⁻¹

la trasmittanza interna (T) di un materiale trasparente è determinata dallo spessore (x) e dal coefficiente d'assorbimento del materiale stesso (α) secondo la legge di lambert-beer $T_{(x)} = e^{-\alpha x}$
 the internal transmittance of a transparent material (T) is determined by the thickness (x) and by the absorbing coefficient of the material itself (α) due to lambert-beer law $T_{(x)} = e^{-\alpha x}$

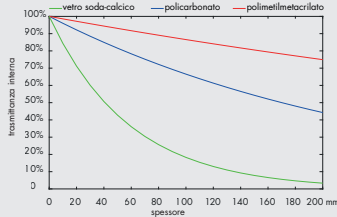

lensoptica amP è allo stesso tempo una lente e un riflettore, perché i raggi di luce subiscono rifrazione e riflessione totale interna. per questa caratteristica tecnica riesce a coniugare alta efficienza e accurato controllo direzionale della luce.
lensoptica amP is both a lens and a reflector at the same time, because the rays of light undergo refraction and total internal reflection. for this technical characteristic it combines high efficiency and accurate directional control of light.

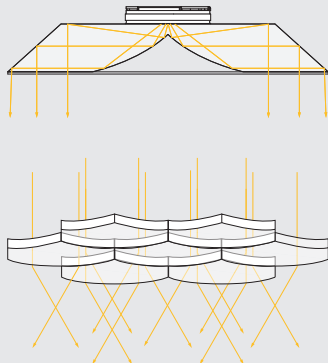

la superficie emittente di **lensoptica amP** è dotata di una matrice di microlenti. ogni microlente riceve un fascio collimato e in funzione della curvatura ne allarga l'apertura angolare in modo controllato.
 la sovrapposizione dei contributi delle singole microlenti produce una distribuzione d'illuminazione uniforme.
 le **lensoptica amP** si suddividono in quattro categorie di apertura angolare del fascio: stretto, medio, largo ed ellittico. il valore esatto dell'angolo dipende dal diametro della sorgente.
lensoptica amP emitter surface is equipped with a microlens array. each microlens receives a collimated beam and according to its curvature it enlarges the angular opening in a controlled way.
 the overlap of the emissions of each microlens creates a uniform distribution of illumination.
lensoptica amP are divided into four categories based on the angular opening of the beam: narrow, medium, wide and elliptical. the exact value of the angle depends on the source diameter.

lensoptica amP è il risultato di una ricerca sviluppata da Viabizzuno su progetto david chipperfield architects con lo studio internazionale di ingegneria arup per fornire alle sorgenti luminose elettroniche un'ottica ad alta efficienza in grado di avere sia una luce concentrata che diffusa. l'alta efficienza viene ottenuta utilizzando un materiale ad altissima trasparenza, il polimetilmetacrilato, per mezzo di prismi catadiottrici progettati per riflettere e trasmettere la luce minimizzando le perdite per assorbimento: tali elementi riflettono verso il basso il 90% del flusso luminoso incidente e ne trasmettono il 10% garantendo così una percentuale di emissione indiretta, non ottenibile con il riflettore in metallo.

la matrice di microlenti regola in modo preciso l'ampiezza angolare del fascio luminoso. l'ampia superficie emittente garantisce un alto comfort visivo e UGR<19.

lensoptica amP is the result of a long research and development process made by Viabizzuno on a david chipperfield architects with arup, international engineering studio, design to provide electronic light sources with a high efficiency optics that can have either a focused and a diffuse light. high efficiency is achieved thanks to a very high transparent material, i.e. polymethyl methacrylate, by means of catadioptric prisms specifically designed to reflect and transmit light reducing losses due to absorption: these elements, reflect 90% of the incident light flow downwards and transmit 10% of it, assuring this way a percentage of indirect emission which could not be reached with metal reflector. the microlens array precisely regulates the angular amplitude of the light beam. the large emitter surface limits luminance, ensuring high visual comfort and UGR<19.

lensoptica amP150
13° les9

fascio stretto - narrow beam

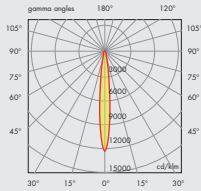

lensoptica amP150 22°
les19

fascio stretto - narrow beam

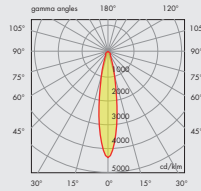

lensoptica amP150 51°
les19

fascio largo - wide beam

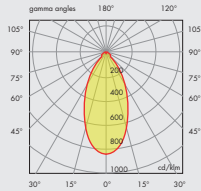

lensoptica amP180 10°
les9

fascio stretto - narrow beam

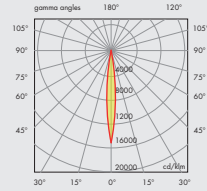

lensoptica amP180 15°
les19

fascio stretto - narrow beam

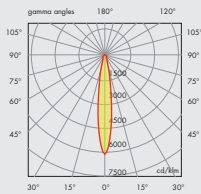

lensoptica amP180 41°
les19

fascio medio - medium beam

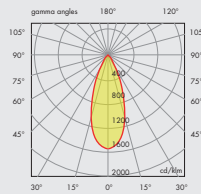

lensoptica amP180 53°
les19

fascio largo - wide beam

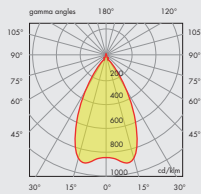

lensoptica amP180 20°x55°
les19

fascio ellittico - elliptical beam

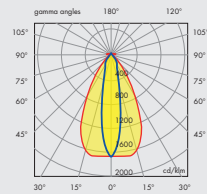

lensoptica amP150
fascio stretto - narrow beam



lensoptica amP180
fascio stretto - narrow beam



lensoptica amP180
fascio medio - medium beam

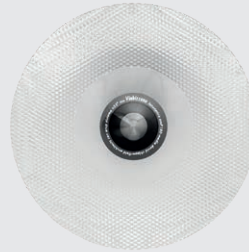

lensoptica amP150
fascio largo - wide beam



lensoptica amP180
fascio largo - wide beam

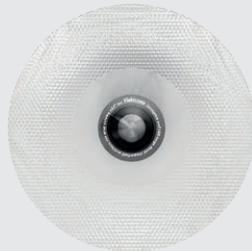

lensoptica amP180
fascio ellittico - elliptical beam



lensoptica amP
installazione - mounting

