



Viabizzuno strada principale della frazione di bizzuno in provincia di ravenna dove tra la casa del popolo e la parrocchia, al n°17, sono nato il ventuno luglio millenovecentocinquantacinque. da qui nasce il nome della fabbrica di produzione fondata nel millenovecentonovantaquattro rappresentata da uno spazio bianco attraversato da due linee. una verticale, rigorosa, essenziale, equilibrata: la luce per la luce; ed una inclinata, irriverente nello spazio, ironica, fuori dagli schemi: la luce per la forma. distinte ma complementari si fondono in un unico nome: Viabizzuno.

marionanni

Viabizzuno is the name of the main road of the small village bizzuno located in the province of ravenna, where I was born on the twenty-first july nineteenfiftyfive at n°17, between the 'casa del popolo' and the local parish church. from here the name of the factory founded in nineteen ninety-four represented by a white space intersected by two lines. one vertical, well balanced, logical, essential: the light for the light. the other one dynamic, irreverent, ironic: the light for the form. separate and yet complementary they cast in the same name: Viabizzuno.

prodotto
product



schede tecniche
technical data sheet



curve fotometriche
photometric curves



modelli 3d per i tuoi render
3d models for your render





apparecchio di illuminazione da soffitto, parete, tavolo, terra e sospensione per interni IP20. realizzato in estruso di alluminio ossidato di sezione 13x13mm. composto da profili ciechi o chiusi a 45° da un diffusore estruso in policarbonato satinato della stessa lunghezza del profilo con aletta antiabbagliamento 4mm.

modelli:

13° angolo 500mm, 1000mm, 2000mm o 3000mm fino a 39W 3744lm,

13° angolo 01 210x297x630mm, 22,5W 2160lm,

13° angolo 02 210x297x1050mm, 33W 3168lm,

13° angolo 03 210x297x1864mm, 47W 9600lm,

13° angolo sospensione 210x297x1864mm, 96W 9600lm, sospeso tramite otto cavi di acciaio 3000mm.

cablato con sorgente elettronica lineare con limitatore di corrente integrato 3000K Ra95 13W/m.

alimentatore in tensione costante 24Vdc escluso, da installare remoto.

accessori: ripiani, campane in vetro e, solo per modello 13° angolo sospensione, rosoni di alimentazione, cassaforma scomparsa totale laterizio e cartongesso.

finiture: acciaio acciaio e nero55.

personalizza la tua luce vai su www.Viabizzuno.com

IP20 rated ceiling, wall, table, floor standing and suspension light fitting for indoor use. made of extruded oxidised aluminium with a 13x13mm square section. consisting of blind profiles or closed ones at 45° by an extruded frosted polycarbonate diffuser the same length as the profile with 4mm long anti-glare louvre.

versions:

13° angolo 500mm, 1000mm, 2000mm or 3000mm up to 39W 3744lm,

13° angolo 01 210x297x630mm, 22,5W 2160lm,

13° angolo 02 210x297x1050mm, 33W 3168lm,

13° angolo 03 210x297x1864mm, 47W 9600lm,

13° angolo sospensione 210x297x1864mm, 96W 9600lm, suspended by eight 3000mm steel cables.

wired with a linear 3000K Ra95 13W/m led source with integrated current limiter.

24Vdc constant voltage power supply not included, to be installed remotely.

accessories: shelves, glass bells and, only for 13° angolo sospensione version, power supply roses, plasterboard and brickwork fully concealed housing.

finishes: acciaio acciaio and nero55.

customize your light visit www.Viabizzuno.com

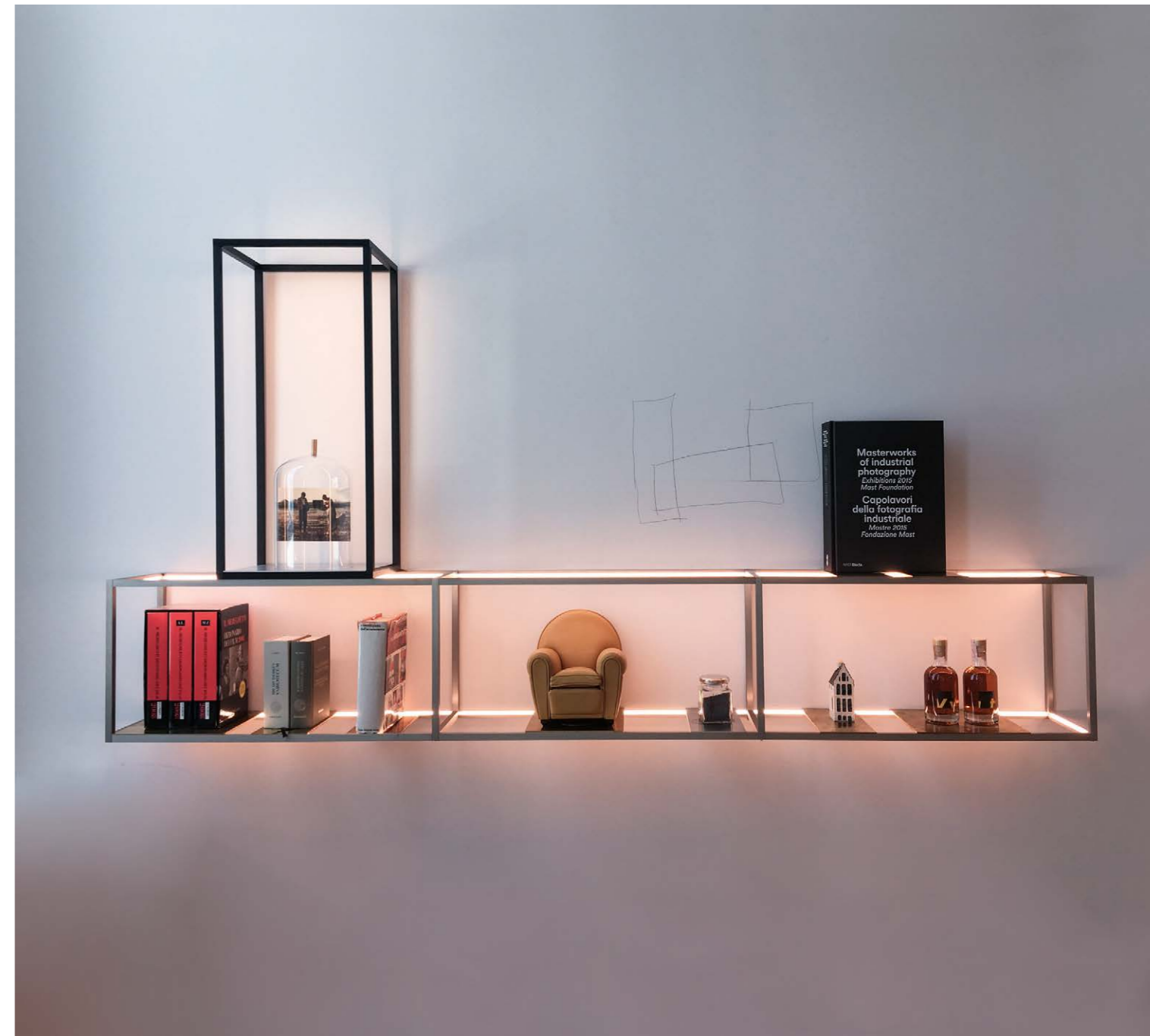

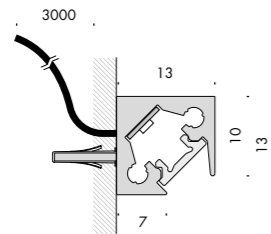

13° angolo 24Vdc

Vb6.583.01.1	acciaio acciaio	3000K	6,5W	500mm	0,1
Vb6.583.02	nero55	3000K	6,5W	500mm	0,1
Vb6.583.11.1	acciaio acciaio	3000K	13W	1000mm	0,2
Vb6.583.12	nero55	3000K	13W	1000mm	0,2
Vb6.583.21.1	acciaio acciaio	3000K	26W	2000mm	0,4
Vb6.583.22	nero55	3000K	26W	2000mm	0,4
Vb6.583.31.1	acciaio acciaio	3000K	39W	3000mm	0,5
Vb6.583.32	nero55	3000K	39W	3000mm	0,5

Ra	R9	ies tm/30		sdc	Vf	lm/m	W/m	lm/W
95	90	Rf 93	Rg 102	step 2	24	1250	13	96
V0001		5,9 Ta25 °C		vita media · average life		50000 h	L80	B10

interasse fori di installazione
installation hole centres

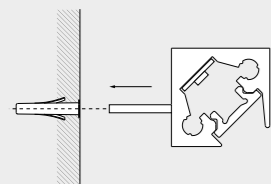

Vb6.583.01.1
Vb6.583.02

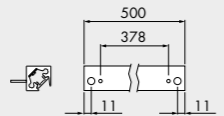

Vb6.583.11.1
Vb6.583.12

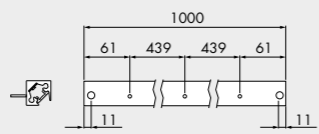

Vb6.583.21.1
Vb6.583.22

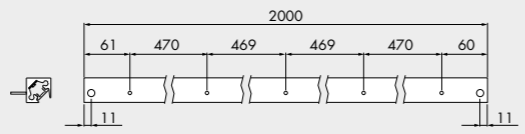

Vb6.583.31.1
Vb6.583.32

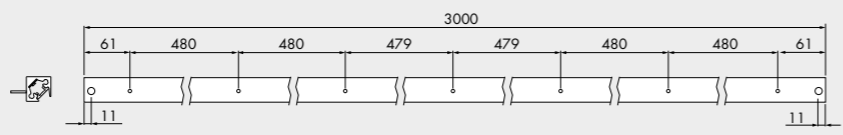

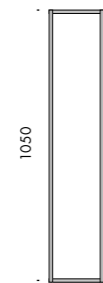
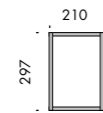
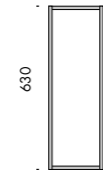
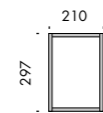
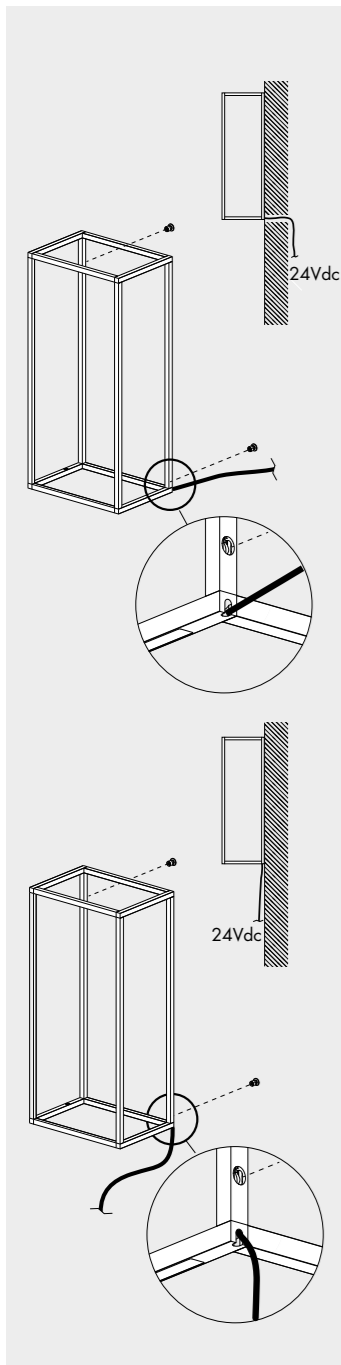

13° angolo 01 24Vdc

Vb2.583.01.1.br acciaio acciaio 3000K 22,5W 0,6

Vb2.583.02.br nero55 3000K 22,5W 0,6

Ra	R9	ies tm/30		sdc	Vf	lm/m	W/m	lm/W
95	90	Rf 93	Rg 102	step 2	24	1250	13	96
V0001		5,9 Ta25 °C		vita media · average life		50000 h	L80 B10	

13° angolo 02 24Vdc

Vb4.583.01.1.br acciaio acciaio 3000K 33W 0,6

Vb4.583.02.br nero55 3000K 33W 0,6

Ra	R9	ies tm/30		sdc	Vf	lm/m	W/m	lm/W
95	90	Rf 93	Rg 102	step 2	24	1250	13	96
V0001		5,9 Ta25 °C		vita media · average life		50000 h	L80 B10	



installazione verticale 13° angolo 03
con ripiani:
usare kit di fissaggio a parete
13° angolo 03 vertical installation
with shelves: use wall fixing kit



kit fissaggio inclusi
fixing kit included

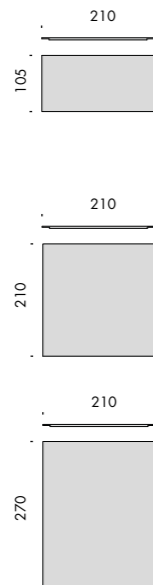
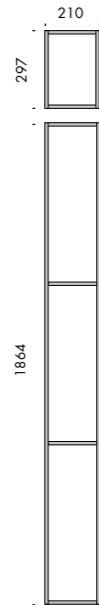
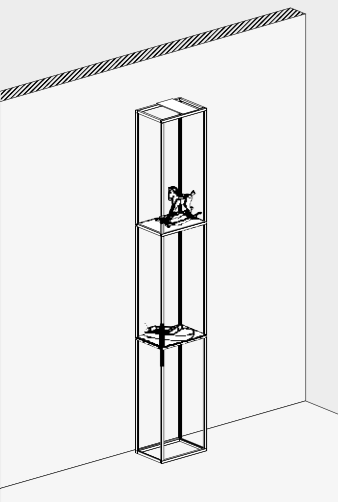
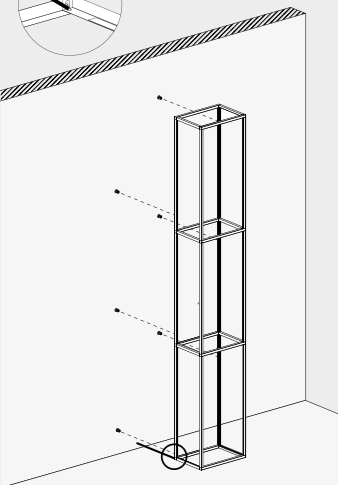

13° angolo 03 24Vdc

Vb4.583.11.bt acciaio acciaio 3000K 47W 0,6

Vb4.583.12.bt nero55 3000K 47W 0,6

Ra	R9	ies tm/30		sdc	Vf	lm/m	W/m	lm/W
95	90	Rf 93	Rg 102	step 2	24	1250	13	96
V0001		5,9 Ta25 °C		vita media · average life		50000 h	L80 B10	

ripiani. shelves.

Vb9.583.81 nero55 0,3

Vb9.583.82 argento hacca 0,3

Vb9.583.83 ottone ap-s 0,3

Vb9.583.86 nero55 0,6

Vb9.583.87 argento hacca 0,6

Vb9.583.88 ottone ap-s 0,6

Vb9.583.91 nero55 0,7

Vb9.583.92 argento hacca 0,7

Vb9.583.93 ottone ap-s 0,7

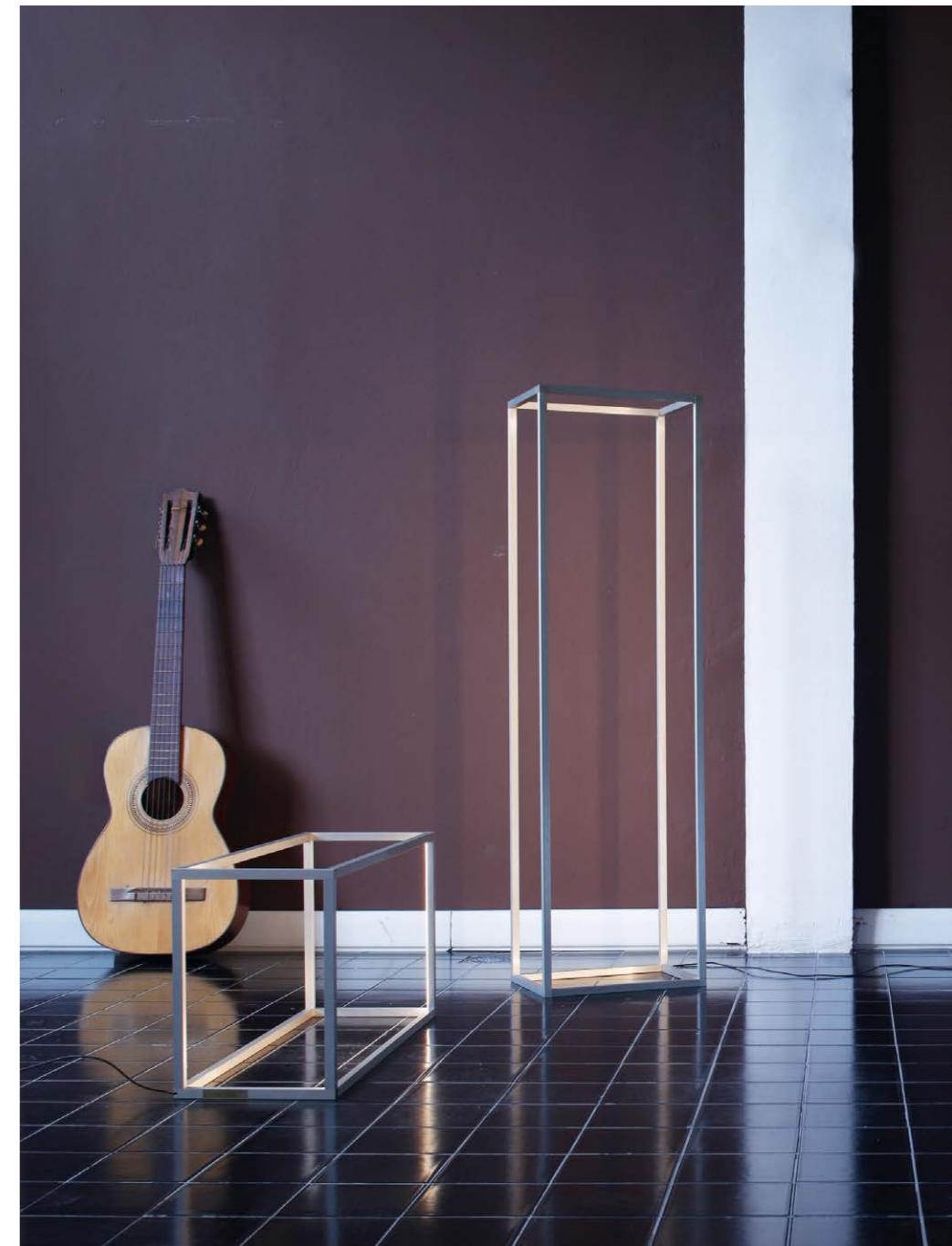





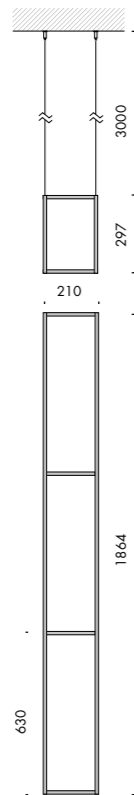
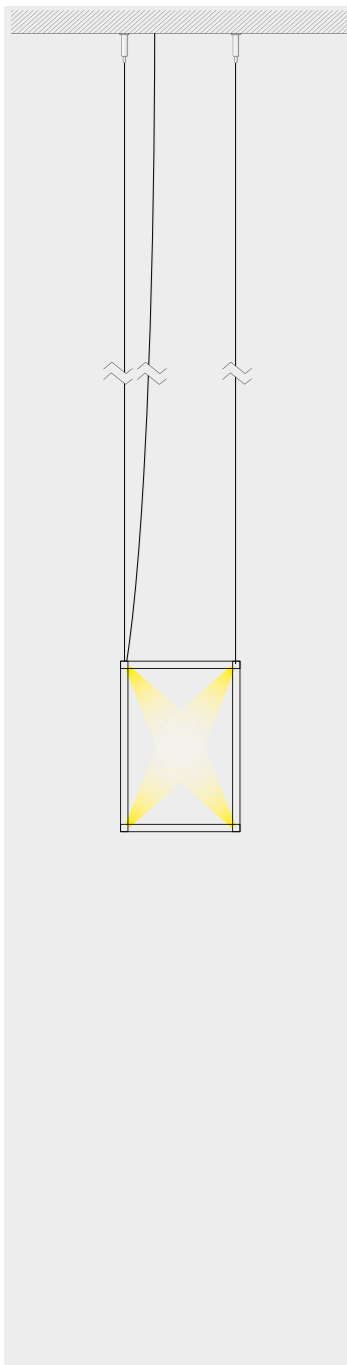

13° angolo sospensione 24Vdc

- Vb8.583.01.1** acciaio acciaio 3000K 96W 2
- Vb8.583.02** nero55 3000K 96W 2

Ra	R9	ies tm/30	sdc	Vf	lm/m	W/m	lm/W
95	90	Rf 93 Rg 102	step 2	24	1250	13	96
V0001		5,9	Ta25 °C vita media · average life		50000 h	L80 B10	

rosone di alimentazione. ceiling rose.

- Vb9.001.77** acciaio acciaio 0,3
- Vb9.001.81** nero55 0,3
- Vb9.580.73** scomparsa totale cartongesso fully concealed plasterboard 0,3
- Vb9.580.74** cassaforma laterizio scomparsa totale fully concealed brick housing 0,3

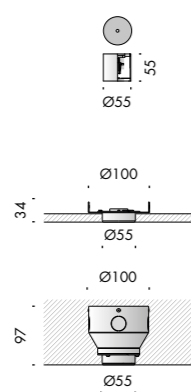

*personalizza la tua luce
vai su Viabizzuno.com*



+

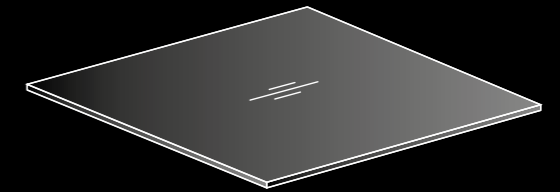

customize your light visit [Viabizzuno.com](https://www.viabizzuno.com)







1. scegli il tuo profilo
choose the profil





2. scegli il ripiano
choose the shelf









lettura delle tabelle tecniche how to read technical tables

xxxxxxxxxxxxxxxx										230V 50-60Hz 																																																	
a	b	c	d	e	f	g	g	h	i																																																		

xxxxxxxxxxxxxxxx										230V 50-60Hz 																																																	
Vbx.xxx.xx	nero55									3000K	35W																																																
l	m									n	o																																																

componenti. components. IK10  

accessori. accessories. IK10  

1	2	3	4	5	6	7	8	9										
Ra	R9	ies tm-30		sdcM	mA	V _{f (min)}	lm	W	lm/W									
98	98	Rf 96	Rg 103	step 1	350	27,6	1240	9,7	128									
					500	27,9	1580	14,0	113									
xm000	les19 	Ta25 °C		vita media · average life	70000 h		L80	B10										
10	11									12	13							

bandella tecnica. posizioni standard simbologie.
data plate. standard arrangement of symbols.

a	nome apparecchio di illuminazione · light fitting name
b	tensione di alimentazione · supply rating (Volt)
c	frequenza di alimentazione · supply frequency (Hertz)
d	alimentatore incluso o escluso · power supply included or not included
e	classe di isolamento · insulation class
f	grado di protezione · protection degree
g	marchio di certificazione · safety and quality standards certification
h	conforme alle direttive europee produced in compliance with EC directives
i	peso netto · net weight (kg)
l	codice · code
m	finitura · finish
n	temperatura colore sorgente elettronica colour temperature led source (Kelvin)
o	potenza della sorgente · source power (Watt)

componenti. identifica tutti gli elementi indispensabili per la corretta funzionalità e installazione dell'apparecchio di illuminazione.
components. includes all items that are essential to the correct operation and installation of the light fitting.

accessori. si riferisce alle ulteriori parti installabili sull'apparecchio.
accessories. refers to items that can be added to the light fitting.

1	indice di resa cromatica · colour rendering index
2	indice di resa del rosso · red colour rendering index
3	Rf indice di fedeltà colore · colour fidelity index Rg indice di saturazione colore · color gamut index
4	step di macadam · macadam step
5	corrente di alimentazione · power supply current
6	tensione di alimentazione · power supply voltage
7	flusso luminoso · light flux
8	potenza della sorgente · source power
9	efficienza della sorgente · source efficiency
10	codice sorgente elettronica Viabizzuno · Viabizzuno led source code
11	superficie emittente · light emitting surface (mm)
12	% flusso residuo a fine vita · end life % flux
13	% consentita sotto limite · allowed % under limit

























gradi di protezione protection degrees

IPOX	non protetto no protection
IP1X	contro corpi estranei >50 mm protection against solid objects
IP2X	contro corpi estranei >12 mm protection against solid objects
IP3X	contro corpi estranei >2,5 mm protection against solid objects
IP4X	contro corpi estranei >1 mm protection against solid objects
IP5X	protezione da polvere dust-protected
IP6X	stagno alla polvere dust-proof

IPX0	non protetto no protection
IPX1	protetto contro la caduta verticale di gocce d'acqua protected against water drops falling vertically
IPX2	protetto contro la caduta di gocce con inclinazione max 15° protected against water drops max inclination 15°
IPX3	protetto contro la caduta di gocce con inclinazione max 60° protected against water drops max inclination 60°
IPX4	protetto contro spruzzi d'acqua protected against sprinkling water
IPX5	protetto contro getti d'acqua protected against water jets
IPX6	protetto contro inondazioni rotected against flooding
IPX7	per breve immersione protected against brief immersions
IPX8	per immersione prolungata protected against long immersion

IK01	nessuna protezione no protection
IK01	protetto contro l'energia d'urto 0,15J protected against collision energy
IK02	protetto contro l'energia d'urto 0,2J protected against collision energy
IK03	protetto contro l'energia d'urto 0,35J protected against collision energy
IK04	protetto contro l'energia d'urto 0,5J protected against collision energy
IK05	protetto contro l'energia d'urto 0,7J protected against collision energy
IK06	protetto contro l'energia d'urto 1J protected against collision energy
IK07	protetto contro l'energia d'urto 2J protected against collision energy
IK08	protetto contro l'energia d'urto 5J protected against collision energy
IK09	protetto contro l'energia d'urto 10J protected against collision energy
IK10	protetto contro l'energia d'urto 20J protected against collision energy

legenda simboli symbols key

	<i>tavolo</i> · table
	<i>terra</i> · floor standing
	<i>soffitto</i> · ceiling
	<i>parete</i> · wall
	<i>sospensione</i> · suspension
	<i>binario</i> · track
	<i>incasso</i> · recessed
	<i>scomparsa totale</i> · fully concealed
	<i>segnaletica+emergenza</i> · signalling system+emergency
	<i>portatili autoalimentati a batteria</i> · portable self-powered with battery
	<i>sistemi</i> · systems
	<i>palo</i> · pole
	<i>paletto</i> · bollard
	<i>seduta</i> · sitting
	<i>disponibile su</i> · available on <i>Viabizzuno applight</i> <i>www.Viabizzuno.com</i> <i>Viabizzuno online</i>
	<i>classe I. solo isolamento fondamentale, le parti conduttrici accessibili sono collegate ad un conduttore di terra. messa a terra tassativa</i> class I. only basic insulation, accessible conductors are earthed. earthing compulsory
	<i>classe II. all'isolamento principale è aggiunto un secondo isolamento oppure ai due isolamenti è sostituito un isolamento rinforzato. messa a terra esclusa</i> class II. basic insulation plus second insulation or both are replaced by reinforced insulation. earthing excluded
	<i>classe III. alimentazione effettuata con bassissima tensione di sicurezza; sono escluse tensioni superiori a 50V-50Hz. messa a terra non prevista.</i> class III. very low safety supply tension; not to be used over 50V-50Hz. earthing excluded.
	<i>prodotto conforme alle direttive europee</i> · produced in compliance with ec directives
	<i>marchio di certificazione europea. certifica che il prodotto è conforme alle norme europee sulla sicurezza</i> component approved for north american market and suitable to be used and approved as part of a more complex system
	<i>componente certificato per il mercato nord americano idoneo ad essere utilizzato e valutato come parte di in un sistema più complesso</i> component approved for north american market and suitable to be used and approved as part of a more complex system
	<i>apparecchio di illuminazione approvato da kema</i> · kema approved light fitting
	<i>prodotto conforme agli standard presenti nel regno unito che regolamentano la sicurezza e la qualità dell'acqua</i> · product complies with uk standards set out by water regulations
	<i>apparecchio di illuminazione certificato secondo le normative vigenti in polonia che regolamentano i dispositivi di sicurezza antincendio</i> certified light fitting according to the regulations about devices for fire safety in force in poland
	<i>prodotto idoneo per essere commercializzato nel mercato cinese</i> · product suitable for the china market
	<i>prodotto finito idoneo per essere commercializzato nel mercato nord americano</i> · listed product suitable for the north american market
	<i>apparecchio di illuminazione certificato per il mercato cinese</i> light fitting certified for china market

	<i>vetro opalino</i> · opal glass
	<i>vetro sabbiato</i> · sanded glass
	<i>vetro nero fumè</i> · black smoke glass
	<i>vetro trasparente</i> · transparent glass
	<i>vetro bianco latte</i> · white milk glass
	<i>crystallo</i> · crystal
	<i>policarbonato opalino</i> · opal polycarbonate diffuser
	<i>carrabile</i> · drive over
	<i>alimentatore incluso</i> · power supply included
	<i>alimentatore escluso</i> · power supply not included
	<i>alimentatore remoto incluso</i> · remote power supply included
	<i>alimentatore elettronico con controllo intelligente incluso</i> · electronic power supply with smart control included
	<i>alimentatore elettronico con controllo intelligente incluso, da installare remoto</i> · electronic power supply with smart control included, to be installed remotely
	<i>alimentatore a spina incluso</i> · plug power supply included
	<i>trasformatore incluso</i> · transformer included
	<i>trasformatore escluso</i> · transformer not included
	<i>kit di cablaggio</i> · wiring kit
	<i>kit di cablaggio escluso</i> · wiring kit not included
	<i>lampadina con sorgente elettronica led, ad incandescenza, alogena o fluorescente inclusa.</i> bulb with led electronic source, incandescent, halogen or fluorescent included.
	<i>lampadina con sorgente elettronica led, ad incandescenza, alogena o fluorescente esclusa.</i> bulb with led electronic source, incandescent, halogen or fluorescent not included.
	<i>propulsore dinamico n55 incluso</i> · included
	<i>possibilità di combinazione tra interfaccia n55, propulsore dinamico n55 e lampadina n55</i> · possible combination between n55 interface, propulsore dinamico n55 and n55 bulb
	<i>attenzione: sorgente luminosa led. non guardare mai direttamente a occhio nudo</i> · attention: led light source. never look straight without eye protection
	<i>flicker free compatibile con fotocamere digitali</i> · flicker free digital camera friendly
l.d.	<i>luce diretta</i> · direct light
l.i.	<i>luce indiretta</i> · indirect light
.d1	<i>dimmerazione 1-10V</i> · 1-10V dimmable
.d2	<i>dimmerazione dali</i> · dimmable dali
.SA	<i>kit luce + emergenza sempre accese. attenzione: non è possibile installare nelle cassaforme laterizio</i> light kit + permanently lit emergency lamp. please note: cannot be installed in brickwork housing
.SE	<i>solo emergenza sempre accesa. attenzione: non è possibile installare nelle cassaforme laterizio</i> permanently lit emergency lamp only. please note: cannot be installed in brickwork housing
	<i>peso netto</i> · net weight (kg)