



Viabizzuno strada principale della frazione di bizzuno in provincia di ravenna dove tra la casa del popolo e la parrocchia, al n°17, sono nato il ventuno luglio millenovecentocinquantacinque. da qui nasce il nome della fabbrica di produzione fondata nel millenovecentonovantaquattro rappresentata da uno spazio bianco attraversato da due linee. una verticale, rigorosa, essenziale, equilibrata: la luce per la luce; ed una inclinata, irriverente nello spazio, ironica, fuori dagli schemi: la luce per la forma. distinte ma complementari si fondono in un unico nome: Viabizzuno.

marionanni

Viabizzuno is the name of the main road of the small village bizzuno located in the province of ravenna, where I was born on the twenty-first july nineteenfiftyfive at n°17, between the 'casa del popolo' and the local parish church. from here the name of the factory founded in nineteen ninety-four represented by a white space intersected by two lines. one vertical, well balanced, logical, essential: the light for the light. the other one dynamic, irreverent, ironic: the light for the form. separate and yet complementary they cast in the same name: Viabizzuno.

prodotto
product



schede tecniche
data sheets



curve fotometriche
photometric curves



modelli 3d per i tuoi render
3d models for your render





apparecchio di illuminazione palo, parete, soffitto e sospensione per esterni IP55.

composto da diffusore luminoso diametro Ø224mm h.739mm in alluminio ossidato e verniciato a polvere con ampolla in vetro soffiato temprato extrachiaro, completo di chiave a nastro per serraggio vetro. eventuali irregolarità del vetro sono garanzia di un prodotto unico, soffiato e realizzato interamente a mano da maestri vetrai.

modelli:

lanterna massima palo, realizzato con palo rastremato in acciaio zincato a caldo e verniciato a polvere, di altezza massima 4500mm fuori terra. diametro Ø102mm fino a 2000mm, diametro Ø60mm nella parte superiore. diffusore luminoso fissato al palo attraverso un morsetto completo di sostegno tubolare in acciaio

lanterna massima parete, fissato a parete attraverso sostegno 60x140x140mm completo di tubolare in acciaio calandrato di forma irregolare.

lanterna massima soffitto diametro Ø224mm h.739mm.

lanterna massima sospensione diametro Ø224mm h.1648mm con tige rigida. cablato con sorgente elettronica 3000K 38,4W 1050mA 4250lm.

accessori: lente ellittica.

alimentatore escluso.

finiture: bruno antico.

IP55 rated pole, wall, ceiling and suspended light fitting for outdoor use. it consists of a Ø224mm h.739mm oxidised and powder coated aluminium light diffuser with an extra-clear tempered blown glass ampoule, complete of strap wrench for glass screwing. any irregularities in the glass are a guarantee of an unique product, blown and entirely hand crafted by master glassmakers.

versions:

lanterna massima palo consists of a hot galvanised and powder painted steel tapered pole, with a maximum height of 4500 mm above ground. the diameter ranges from 102mm to 2000mm; the diameter of the upper part is 60mm. the light diffuser is affixed to the pole by means of a clamp holding a steel tubular support.

lanterna massima parete, wall mounted by means of a 60x140x140mm support equipped with an unevenly shaped calendered steel pipe.

lanterna massima soffitto Ø224mm h.739mm.

lanterna massima sospensione Ø224mm h.1648mm with rigid rod. wired with 3000K 38.4W 1050mA 4250lm led source.





accessories: elliptical lens.

power supply not included.

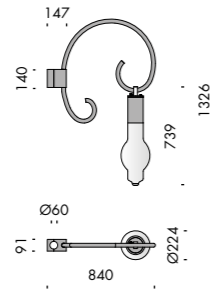
finish: antique brown.







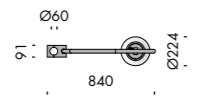

lanterna massima diffusore   IP55 IK07   

Vb4.553.01.bt bruno antico · antique brown 3000K 15

Ra	ies tm-30	sdc	mA	V _f (min)	lm	W	lm/W
90	Rf 90 Rg 100	step 2	1050	34,1	4250	38,4	119
tm011	les19  Ta25 °C	vita media · average life	50000 h	L70 B10			



lanterna massima palo   

a9.553.81 bruno antico · antique brown 4500mm 22

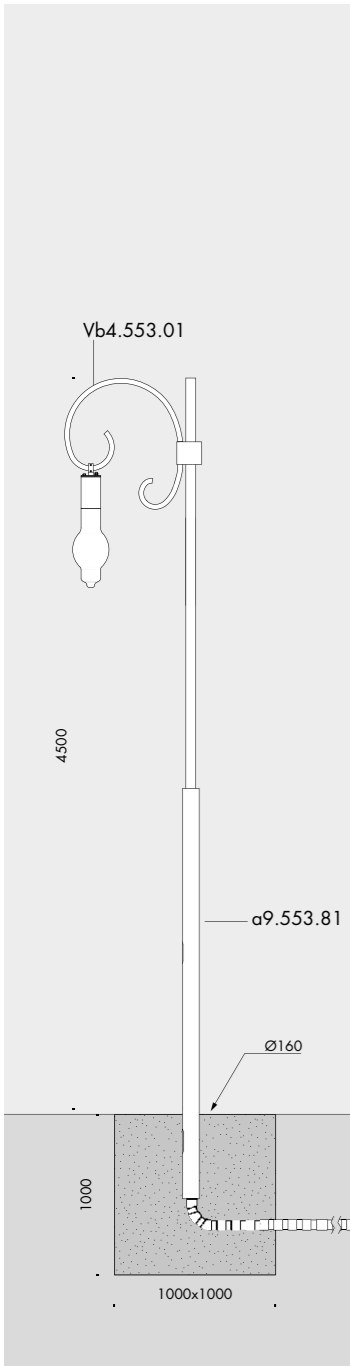
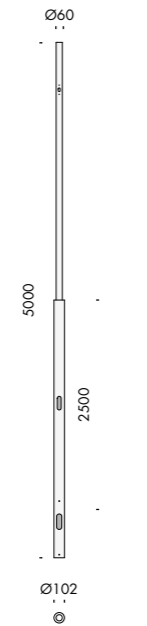

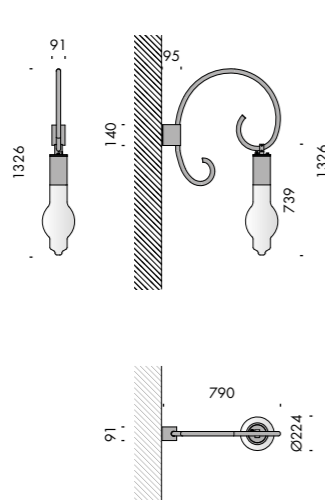

lanterna massima parete

Vb6.553.11.bt bruno antico · antique brown 3000K 15

Ra	ies tm-30	sdc	mA	V _f (min)	lm	W	lm/W
90	Rf 90 Rg 100	step 2	1050	34,1	4250	38,4	119
tm011	les19 Ta25 °C	vita media · average life		50000 h	L70 B10		

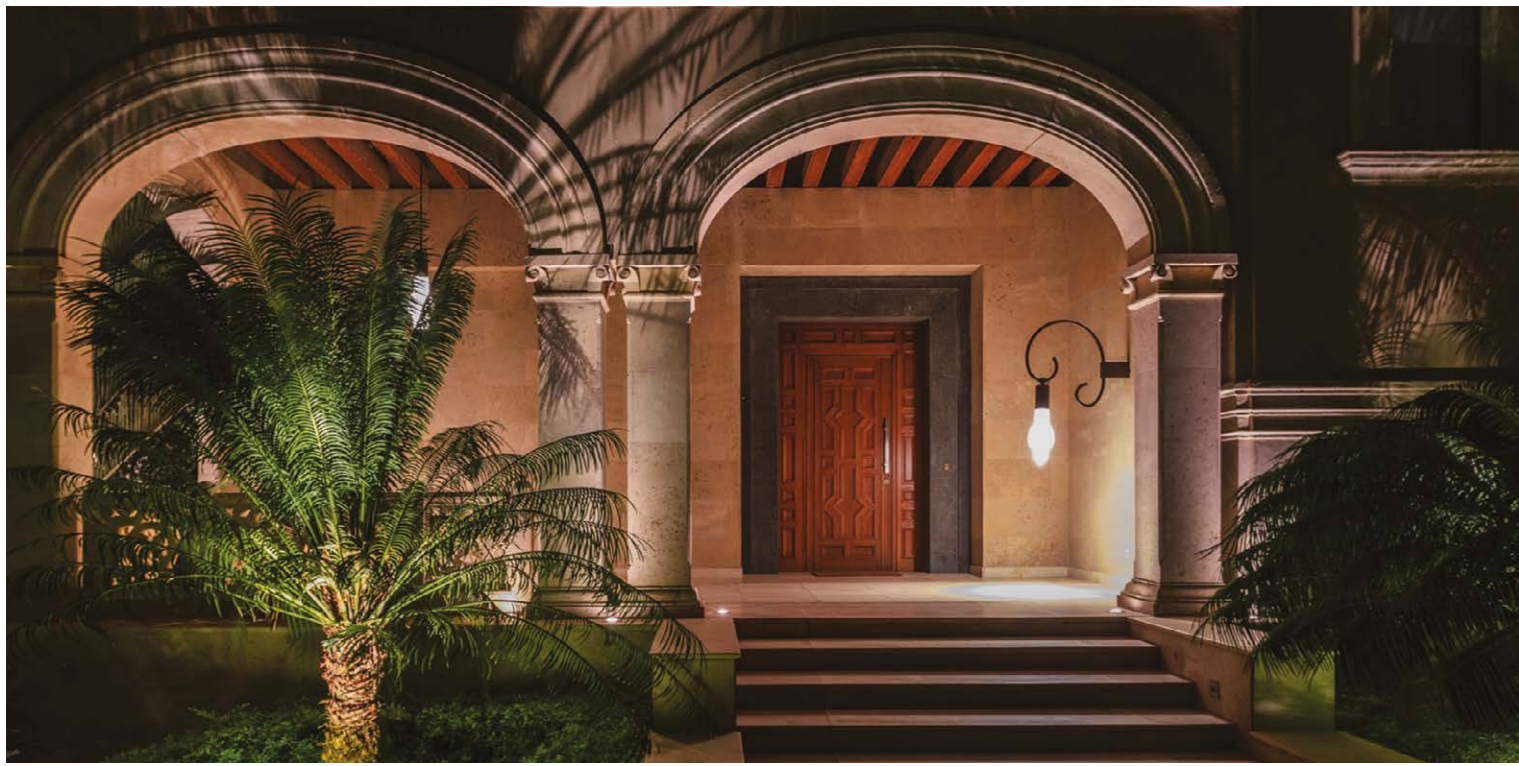

installazione a soffitto con viti e tasselli
ceiling installation with screws and dowels

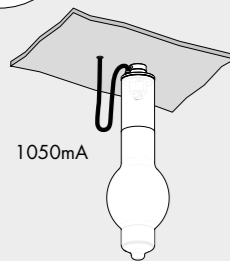
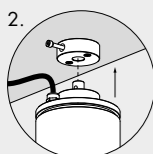
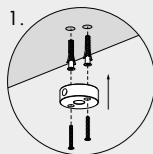

installazione a soffitto con gancio
ceiling installation with hook

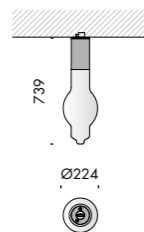
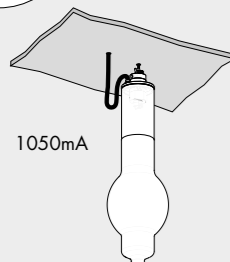
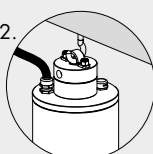



lanterna massima soffitto  IP55 IK07   

Vb6.553.21.bt bruno antico · antique brown 3000K 2,2

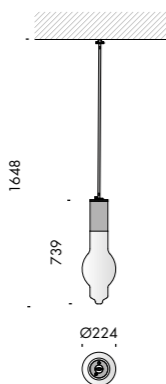
Ra	ies tm-30		sdc	mA	V _f (min)	lm	W	lm/W
90	Rf 90	Rg 100	step 2	1050	34,1	4250	38,4	119
tm011	les19	● Ta25 °C	vita media · average life		50000 h	L70 B10		



lanterna massima sospensione  IP55 IK07   

Vb8.553.31.bt bruno antico · antique brown 3000K 2,2

Ra	ies tm-30		sdc	mA	V _f (min)	lm	W	lm/W
90	Rf 90	Rg 100	step 2	1050	34,1	4250	38,4	119
tm011	les19	● Ta25 °C	vita media · average life		50000 h	L70 B10		



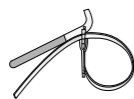

componenti. components. ☆ CE ⓘ

a9.553.90 chiave a nastro per serraggio vetro
strap wrench for glass screwing 0,4

accessori. accessories. ☆ CE ⓘ

Vb9.553.81 lente ellittica · elliptical lens 0,1



lettura delle tabelle tecniche how to read technical tables

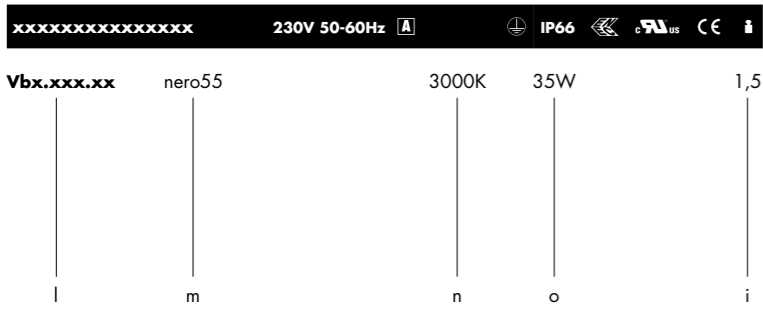
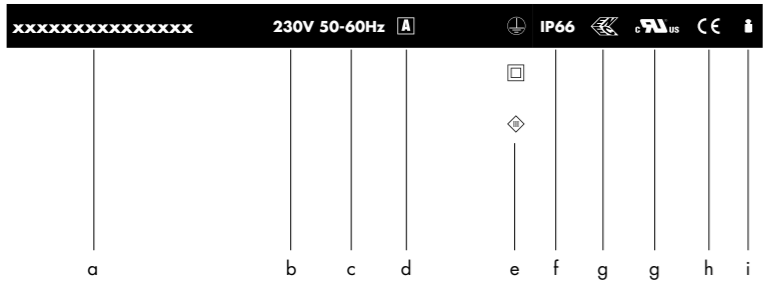

componenti. components. IK10 CE

accessori. accessories. IK10 CE

1	2	3	4	5	6	7	8	9	
Ra	R9	ies tm-30		sdcM	mA	V _{f (min)}	lm	W	lm/W
98	98	Rf 96	Rg 103	step 1	350	27,6	1240	9,7	128
					500	27,9	1580	14,0	113
xm000	les19	Ta25 °C		vita media · average life		70000 h	L80	B10	
10	11						12	13	

bandella tecnica. posizioni standard simbologie.
data plate. standard arrangement of symbols.

a	nome apparecchio di illuminazione · light fitting name
b	tensione di alimentazione · supply rating (Volt)
c	frequenza di alimentazione · supply frequency (Hertz)
d	alimentatore incluso o escluso · power supply included or not included
e	classe di isolamento · insulation class
f	grado di protezione · protection degree
g	marchio di certificazione · safety and quality standards certification
h	conforme alle direttive europee produced in compliance with EC directives
i	peso netto · net weight (kg)
l	codice · code
m	finitura · finish
n	temperatura colore sorgente elettronica colour temperature led source (Kelvin)
o	potenza della sorgente · source power (Watt)

componenti. identifica tutti gli elementi indispensabili per la corretta funzionalità e installazione dell'apparecchio di illuminazione.
components. includes all items that are essential to the correct operation and installation of the light fitting.

accessori. si riferisce alle ulteriori parti installabili sull'apparecchio.
accessories. refers to items that can be added to the light fitting.

























1	indice di resa cromatica · colour rendering index
2	indice di resa del rosso · red colour rendering index
3	Rf indice di fedeltà colore · colour fidelity index Rg indice di saturazione colore · color gamut index
4	step di macadam · macadam step
5	corrente di alimentazione · power supply current
6	tensione di alimentazione · power supply voltage
7	flusso luminoso · light flux
8	potenza della sorgente · source power
9	efficienza della sorgente · source efficiency
10	codice sorgente elettronica Viabizzuno · Viabizzuno led source code
11	superficie emittente · light emitting surface (mm)
12	% flusso residuo a fine vita · end life % flux
13	% consentita sotto limite · allowed % under limit

gradi di protezione protection degrees

IPX0	non protetto no protection	IK01	nessuna protezione no protection
IPX1	protetto contro la caduta verticale di gocce d'acqua protected against water drops falling vertically	IK01	protetto contro l'energia d'urto 0,15J protected against collision energy
IPX2	protetto contro la caduta di gocce con inclinazione max 15° protected against water drops max inclination 15°	IK02	protetto contro l'energia d'urto 0,2J protected against collision energy
IPX3	protetto contro la caduta di gocce con inclinazione max 60° protected against water drops max inclination 60°	IK03	protetto contro l'energia d'urto 0,35J protected against collision energy
IPX4	protetto contro spruzzi d'acqua protected against sprinkling water	IK04	protetto contro l'energia d'urto 0,5J protected against collision energy
IPX5	protetto contro getti d'acqua protected against water jets	IK05	protetto contro l'energia d'urto 0,7J protected against collision energy
IPX6	protetto contro inondazioni protected against flooding	IK06	protetto contro l'energia d'urto 1J protected against collision energy
IPX7	per breve immersione protected against brief immersions	IK07	protetto contro l'energia d'urto 2J protected against collision energy
IPX8	per immersione prolungata protected against long immersion	IK08	protetto contro l'energia d'urto 5J protected against collision energy
IPX9	per immersione prolungata protected against long immersion	IK09	protetto contro l'energia d'urto 10J protected against collision energy
IPX10	per immersione prolungata protected against long immersion	IK10	protetto contro l'energia d'urto 20J protected against collision energy

IPOX	non protetto no protection
IP1X	contro corpi estranei >50 mm protection against solid objects
IP2X	contro corpi estranei >12 mm protection against solid objects
IP3X	contro corpi estranei >2,5 mm protection against solid objects
IP4X	contro corpi estranei >1 mm protection against solid objects
IP5X	protezione da polvere dust-protected
IP6X	stagno alla polvere dust-proof

legenda simboli symbols key

	<i>tavolo</i> · table
	<i>terra</i> · floor standing
	<i>soffitto</i> · ceiling
	<i>parete</i> · wall
	<i>sospensione</i> · suspension
	<i>binario</i> · track
	<i>incasso</i> · recessed
	<i>scomparsa totale</i> · fully concealed
	<i>segnaletica+emergenza</i> · signalling system+emergency
	<i>portatili autoalimentati a batteria</i> · portable self-powered with battery
	<i>sistemi</i> · systems
	<i>palo</i> · pole
	<i>paletto</i> · bollard
	<i>seduta</i> · sitting
	<i>disponibile su</i> · available on <i>Viabizzuno applight</i> <i>www.Viabizzuno.com</i> <i>Viabizzuno online</i>
	<i>classe I. solo isolamento fondamentale, le parti conduttrici accessibili sono collegate ad un conduttore di terra. messa a terra tassativa</i> class I. only basic insulation, accessible conductors are earthed. earthing compulsory
	<i>classe II. all'isolamento principale è aggiunto un secondo isolamento oppure ai due isolamenti è sostituito un isolamento rinforzato. messa a terra esclusa</i> class II. basic insulation plus second insulation or both are replaced by reinforced insulation. earthing excluded
	<i>classe III. alimentazione effettuata con bassissima tensione di sicurezza; sono escluse tensioni superiori a 50V-50Hz. messa a terra non prevista.</i> class III. very low safety supply tension; not to be used over 50V-50Hz. earthing excluded.
	<i>prodotto conforme alle direttive europee</i> · produced in compliance with ec directives
	<i>marchio di certificazione europea. certifica che il prodotto è conforme alle norme europee sulla sicurezza</i> component approved for north american market and suitable to be used and approved as part of a more complex system
	<i>componente certificato per il mercato nord americano idoneo ad essere utilizzato e valutato come parte di in un sistema più complesso</i> component approved for north american market and suitable to be used and approved as part of a more complex system
	<i>apparecchio di illuminazione approvato da kema</i> · kema approved light fitting
	<i>prodotto conforme agli standard presenti nel regno unito che regolamentano la sicurezza e la qualità dell'acqua</i> · product complies with uk standards set out by water regulations
	<i>apparecchio di illuminazione certificato secondo le normative vigenti in polonia che regolamentano i dispositivi di sicurezza antincendio</i> certified light fitting according to the regulations about devices for fire safety in force in poland
	<i>prodotto idoneo per essere commercializzato nel mercato cinese</i> · product suitable for the china market
	<i>prodotto finito idoneo per essere commercializzato nel mercato nord americano</i> · listed product suitable for the north american market
	<i>apparecchio di illuminazione certificato per il mercato cinese</i> light fitting certified for china market

	<i>vetro opalino</i> · opal glass
	<i>vetro sabbiato</i> · sanded glass
	<i>vetro nero fumè</i> · black smoke glass
	<i>vetro trasparente</i> · transparent glass
	<i>vetro bianco latte</i> · white milk glass
	<i>crystallo</i> · crystal
	<i>policarbonato opalino</i> · opal polycarbonate diffuser
	<i>carrabile</i> · drive over
	<i>alimentatore incluso</i> · power supply included
	<i>alimentatore escluso</i> · power supply not included
	<i>alimentatore remoto incluso</i> · remote power supply included
	<i>alimentatore elettronico con controllo intelligente incluso</i> · electronic power supply with smart control included
	<i>alimentatore elettronico con controllo intelligente incluso, da installare remoto</i> · electronic power supply with smart control included, to be installed remotely
	<i>alimentatore a spina incluso</i> · plug power supply included
	<i>trasformatore incluso</i> · transformer included
	<i>trasformatore escluso</i> · transformer not included
	<i>kit di cablaggio</i> · wiring kit
	<i>kit di cablaggio escluso</i> · wiring kit not included
	<i>lampadina con sorgente elettronica led, ad incandescenza, alogena o fluorescente inclusa.</i> bulb with led electronic source, incandescent, halogen or fluorescent included.
	<i>lampadina con sorgente elettronica led, ad incandescenza, alogena o fluorescente esclusa.</i> bulb with led electronic source, incandescent, halogen or fluorescent not included.
	<i>propulsore dinamico n55 incluso</i> · included
	<i>possibilità di combinazione tra interfaccia n55, propulsore dinamico n55 e lampadina n55</i> · possible combination between n55 interface, propulsore dinamico n55 and n55 bulb
	<i>attenzione: sorgente luminosa led. non guardare mai direttamente a occhio nudo</i> · attention: led light source. never look straight without eye protection
	<i>flicker free compatibile con fotocamere digitali</i> · flicker free digital camera friendly
l.d.	<i>luce diretta</i> · direct light
l.i.	<i>luce indiretta</i> · indirect light
.d1	<i>dimmerazione 1-10V</i> · 1-10V dimmable
.d2	<i>dimmerazione dali</i> · dimmable dali
.SA	<i>kit luce + emergenza sempre accese. attenzione: non è possibile installare nelle cassaforme laterizio</i> light kit + permanently lit emergency lamp. please note: cannot be installed in brickwork housing
.SE	<i>solo emergenza sempre accesa. attenzione: non è possibile installare nelle cassaforme laterizio</i> permanently lit emergency lamp only. please note: cannot be installed in brickwork housing
	<i>peso netto</i> · net weight (kg)