



Viabizzuno strada principale della frazione di bizzuno in provincia di ravenna dove tra la casa del popolo e la parrocchia, al n°17, sono nato il ventuno luglio millenovecentocinquantacinque. da qui nasce il nome della fabbrica di produzione fondata nel millenovecentonovantaquattro rappresentata da uno spazio bianco attraversato da due linee. una verticale, rigorosa, essenziale, equilibrata: la luce per la luce; ed una inclinata, irriverente nello spazio, ironica, fuori dagli schemi: la luce per la forma. distinte ma complementari si fondono in un unico nome: Viabizzuno.

marionanni

Viabizzuno is the name of the main road of the small village bizzuno located in the province of ravenna, where I was born on the twenty-first july nineteenfiftyfive at n°17, between the 'casa del popolo' and the local parish church. from here the name of the factory founded in nineteen ninety-four represented by a white space intersected by two lines. one vertical, well balanced, logical, essential: the light for the light. the other one dynamic, irreverent, ironic: the light for the form. separate and yet complementary they cast in the same name: Viabizzuno.

prodotto
product



schede tecniche
technical data sheet



curve fotometriche
photometric curves



modelli 3d per i tuoi render
3d models for your render



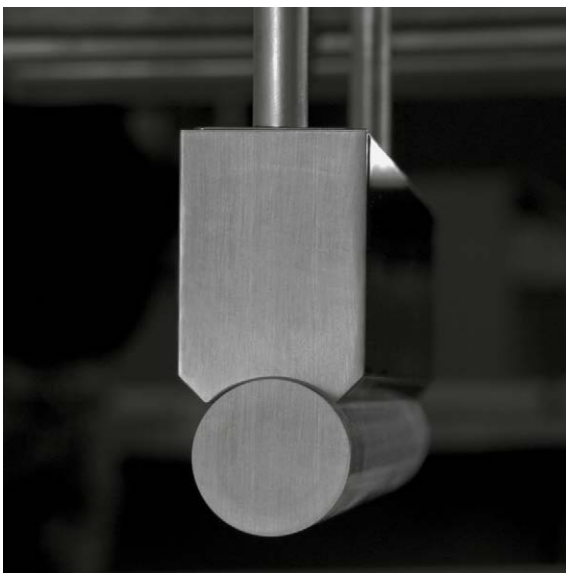

apparecchio di illuminazione a sospensione, soffitto o parete per interni IP20.

realizzato in alluminio ossidato, di sezione 73x35mm 750mm o 1500mm.

modelli:

linee sospensione dotata di due tige rigide 500mm.

linee soffitto.

cablato con sorgente elettronica 3000K Ra95 fino a 38W.

alimentatore escluso.

finiture: argento antico.

IP20 rated suspension, ceiling or wall light fitting for indoor use. made of oxidized aluminium of 73x35mm section 750mm or 1500mm long.

versions:

linee sospensione equipped with two 500mm rigid rods.

linee soffitto.

wired with 3000K Ra95 up to 38W led source.

power supply not included.

finishes: antique silver.

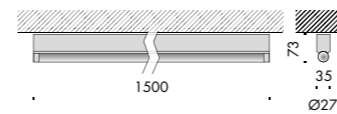
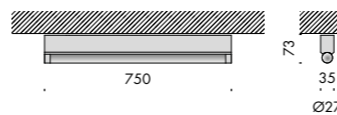
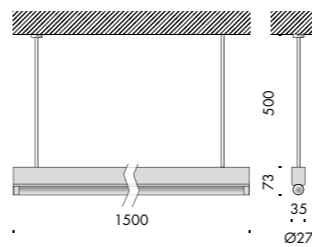
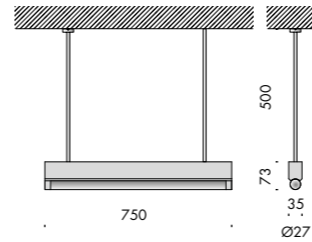

linee sospensione       

Vb8.174.31.bt argento antico · antique silver 3000K 19W 2,3

Vb8.174.41.bt argento antico · antique silver 3000K 38W 4,6

| Ra | R9 | ies tm-30 | sdc | V _f | lm/m | W/m | lm/W |
|-------|--|--------------|---------------------------|----------------|------|-----|------|
| 95 | 90 | Rf 93 Rg 102 | step 2 | 24 | 2500 | 26 | 96 |
| V3001 | 11  | Ta25 °C | vita media · average life | 50000 h | L80 | B10 | |

linee parete soffitto      

Vb8.174.01.bt argento antico · antique silver 3000K 19W 1,8

Vb8.174.11.bt argento antico · antique silver 3000K 38W 3,6

| Ra | R9 | ies tm-30 | sdc | V _f | lm/m | W/m | lm/W |
|-------|--|--------------|---------------------------|----------------|------|-----|------|
| 95 | 90 | Rf 93 Rg 102 | step 2 | 24 | 2500 | 26 | 96 |
| V3001 | 11  | Ta25 °C | vita media · average life | 50000 h | L80 | B10 | |

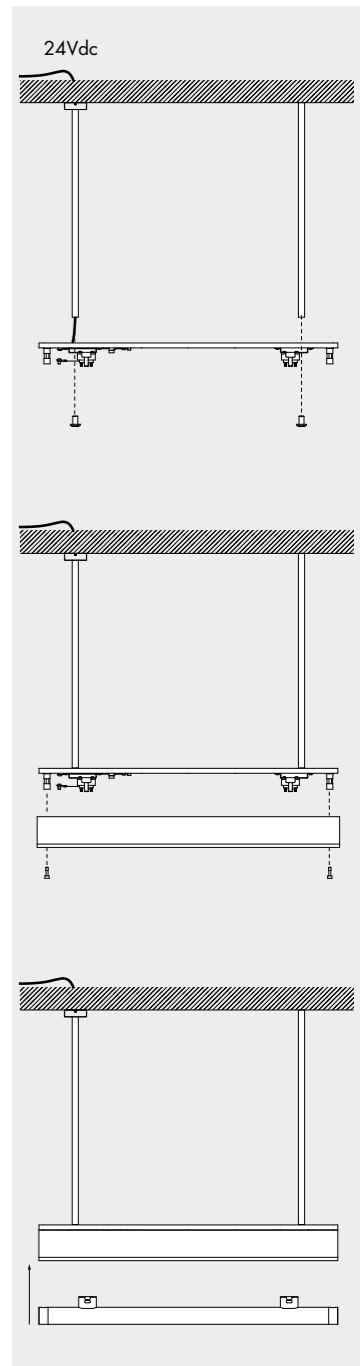



lettura delle tabelle tecniche how to read technical tables

| | | | | | | | | | | | | | | | | | | |
|------------------|---|---|---|---|---|---|---|---|---|--------------|--|---|---|------|---|----|----|---|
| xxxxxxxxxxxxxxxx | | | | | | | | | | 230V 50-60Hz | | A | ⊕ | IP66 | ⚡ | UL | CE | 🔒 |
| a | b | c | d | e | f | g | g | h | i | | | | | | | | | |

| | | | | | | | | | | | | | | | | | | | |
|------------------|--------|-------|--|-----|--|--|--|--|--|--------------|--|---|---|------|---|----|----|---|--|
| xxxxxxxxxxxxxxxx | | | | | | | | | | 230V 50-60Hz | | A | ⊕ | IP66 | ⚡ | UL | CE | 🔒 | |
| Vbx.xxx.xx | nero55 | 3000K | | 35W | | | | | | 1,5 | | | | | | | | | |
| l | m | n | | o | | | | | | i | | | | | | | | | |

| | | | | | | | | | | | | | |
|-------------------------|--|--|--|--|--|--|--|--|--|------|--|----|---|
| componenti. components. | | | | | | | | | | IK10 | | CE | 🔒 |
|-------------------------|--|--|--|--|--|--|--|--|--|------|--|----|---|

| | | | | | | | | | | | | | |
|-------------------------|--|--|--|--|--|--|--|--|--|------|--|----|---|
| accessori. accessories. | | | | | | | | | | IK10 | | CE | 🔒 |
|-------------------------|--|--|--|--|--|--|--|--|--|------|--|----|---|

| | | | | | | | | | | | | | |
|-------|-------|-----------|---------|---------------------------|---------|----------------------|------|-----|------|--|--|--|--|
| 1 | 2 | 3 | 4 | 5 | 6 | 7 | 8 | 9 | | | | | |
| Ra | R9 | ies tm-30 | | sdcM | mA | V _{f (min)} | lm | W | lm/W | | | | |
| 98 | 98 | Rf 96 | Rg 103 | step 1 | 350 | 27,6 | 1240 | 9,7 | 128 | | | | |
| xm000 | les19 | ☀️ | Ta25 °C | vita media · average life | 70000 h | L80 | B10 | | | | | | |
| 10 | 11 | | | | | 12 | 13 | | | | | | |

bandella tecnica. posizioni standard simbologie.
data plate. standard arrangement of symbols.

| | |
|---|---|
| a | nome apparecchio di illuminazione · light fitting name |
| b | tensione di alimentazione · supply rating (Volt) |
| c | frequenza di alimentazione · supply frequency (Hertz) |
| d | alimentatore incluso o escluso · power supply included or not included |
| e | classe di isolamento · insulation class |
| f | grado di protezione · protection degree |
| g | marchio di certificazione · safety and quality standards certification |
| h | conforme alle direttive europee produced in compliance with EC directives |
| i | peso netto · net weight (kg) |
| l | codice · code |
| m | finitura · finish |
| n | temperatura colore sorgente elettronica colour temperature led source (Kelvin) |
| o | potenza della sorgente · source power (Watt) |

componenti. identifica tutti gli elementi indispensabili per la corretta funzionalità e installazione dell'apparecchio di illuminazione.
components. includes all items that are essential to the correct operation and installation of the light fitting.

accessori. si riferisce alle ulteriori parti installabili sull'apparecchio.
accessories. refers to items that can be added to the light fitting.

| | |
|----|--|
| 1 | indice di resa cromatica · colour rendering index |
| 2 | indice di resa del rosso · red colour rendering index |
| 3 | Rf indice di fedeltà colore · colour fidelity index Rg indice di saturazione colore · color gamut index |
| 4 | step di macadam · macadam step |
| 5 | corrente di alimentazione · power supply current |
| 6 | tensione di alimentazione · power supply voltage |
| 7 | flusso luminoso · light flux |
| 8 | potenza della sorgente · source power |
| 9 | efficienza della sorgente · source efficiency |
| 10 | codice sorgente elettronica Viabizzuno · Viabizzuno led source code |
| 11 | superficie emittente · light emitting surface (mm) |
| 12 | % flusso residuo a fine vita · end life % flux |
| 13 | % consentita sotto limite · allowed % under limit |



























gradi di protezione protection degrees

| | |
|------|---|
| IPOX | non protetto no protection |
| IP1X | contro corpi estranei >50 mm protection against solid objects |
| IP2X | contro corpi estranei >12 mm protection against solid objects |
| IP3X | contro corpi estranei >2,5 mm protection against solid objects |
| IP4X | contro corpi estranei >1 mm protection against solid objects |
| IP5X | protezione da polvere dust-protected |
| IP6X | stagno alla polvere dust-proof |

| | |
|------|--|
| IPX0 | non protetto no protection |
| IPX1 | protetto contro la caduta verticale di gocce d'acqua protected against water drops falling vertically |
| IPX2 | protetto contro la caduta di gocce con inclinazione max 15° protected against water drops max inclination 15° |
| IPX3 | protetto contro la caduta di gocce con inclinazione max 60° protected against water drops max inclination 60° |
| IPX4 | protetto contro spruzzi d'acqua protected against sprinkling water |
| IPX5 | protetto contro getti d'acqua protected against water jets |
| IPX6 | protetto contro inondazioni protected against flooding |
| IPX7 | per breve immersione protected against brief immersions |
| IPX8 | per immersione prolungata protected against long immersion |

| | |
|------|--|
| IK01 | nessuna protezione no protection |
| IK01 | protetto contro l'energia d'urto 0,15J protected against collision energy |
| IK02 | protetto contro l'energia d'urto 0,2J protected against collision energy |
| IK03 | protetto contro l'energia d'urto 0,35J protected against collision energy |
| IK04 | protetto contro l'energia d'urto 0,5J protected against collision energy |
| IK05 | protetto contro l'energia d'urto 0,7J protected against collision energy |
| IK06 | protetto contro l'energia d'urto 1J protected against collision energy |
| IK07 | protetto contro l'energia d'urto 2J protected against collision energy |
| IK08 | protetto contro l'energia d'urto 5J protected against collision energy |
| IK09 | protetto contro l'energia d'urto 10J protected against collision energy |
| IK10 | protetto contro l'energia d'urto 20J protected against collision energy |

legenda simboli symbols key

| | |
|---|--|
|  | <i>tavolo</i> · table |
|  | <i>terra</i> · floor standing |
|  | <i>soffitto</i> · ceiling |
|  | <i>parete</i> · wall |
|  | <i>sospensione</i> · suspension |
|  | <i>binario</i> · track |
|  | <i>incasso</i> · recessed |
|  | <i>scomparsa totale</i> · fully concealed |
|  | <i>segnaletica+emergenza</i> · signalling system+emergency |
|  | <i>portatili autoalimentati a batteria</i> · portable self-powered with battery |
|  | <i>sistemi</i> · systems |
|  | <i>palo</i> · pole |
|  | <i>paletto</i> · bollard |
|  | <i>seduta</i> · sitting |
|  | <i>disponibile su</i> · available on <i>Viabizzuno applight</i> <i>www.Viabizzuno.com</i> <i>Viabizzuno online</i> |
|  | <i>classe I. solo isolamento fondamentale, le parti conduttrici accessibili sono collegate ad un conduttore di terra. messa a terra tassativa</i> class I. only basic insulation, accessible conductors are earthed. earthing compulsory |
|  | <i>classe II. all'isolamento principale è aggiunto un secondo isolamento oppure ai due isolamenti è sostituito un isolamento rinforzato. messa a terra esclusa</i> class II. basic insulation plus second insulation or both are replaced by reinforced insulation. earthing excluded |
|  | <i>classe III. alimentazione effettuata con bassissima tensione di sicurezza; sono escluse tensioni superiori a 50V-50Hz. messa a terra non prevista.</i> class III. very low safety supply tension; not to be used over 50V-50Hz. earthing excluded. |
|  | <i>prodotto conforme alle direttive europee</i> · produced in compliance with ec directives |
|  | <i>marchio di certificazione europea. certifica che il prodotto è conforme alle norme europee sulla sicurezza</i> component approved for north american market and suitable to be used and approved as part of a more complex system |
|  | <i>componente certificato per il mercato nord americano idoneo ad essere utilizzato e valutato come parte di in un sistema più complesso</i> component approved for north american market and suitable to be used and approved as part of a more complex system |
|  | <i>apparecchio di illuminazione approvato da kema</i> · kema approved light fitting |
|  | <i>prodotto conforme agli standard presenti nel regno unito che regolamentano la sicurezza e la qualità dell'acqua</i> · product complies with uk standards set out by water regulations |
|  | <i>apparecchio di illuminazione certificato secondo le normative vigenti in polonia che regolamentano i dispositivi di sicurezza antincendio</i> certified light fitting according to the regulations about devices for fire safety in force in poland |
|  | <i>prodotto idoneo per essere commercializzato nel mercato cinese</i> · product suitable for the china market |
|  | <i>prodotto finito idoneo per essere commercializzato nel mercato nord americano</i> · listed product suitable for the north american market |
|  | <i>apparecchio di illuminazione certificato per il mercato cinese</i> light fitting certified for china market |

| | |
|---|---|
|  | <i>vetro opalino</i> · opal glass |
|  | <i>vetro sabbiato</i> · sanded glass |
|  | <i>vetro nero fumè</i> · black smoke glass |
|  | <i>vetro trasparente</i> · transparent glass |
|  | <i>vetro bianco latte</i> · white milk glass |
|  | <i>cristallo</i> · crystal |
|  | <i>policarbonato opalino</i> · opal polycarbonate diffuser |
|  | <i>carrabile</i> · drive over |
|  | <i>alimentatore incluso</i> · power supply included |
|  | <i>alimentatore escluso</i> · power supply not included |
|  | <i>alimentatore remoto incluso</i> · remote power supply included |
|  | <i>alimentatore elettronico con controllo intelligente incluso</i> · electronic power supply with smart control included |
|  | <i>alimentatore elettronico con controllo intelligente incluso, da installare remoto</i> · electronic power supply with smart control included, to be installed remotely |
|  | <i>alimentatore a spina incluso</i> · plug power supply included |
|  | <i>trasformatore incluso</i> · transformer included |
|  | <i>trasformatore escluso</i> · transformer not included |
|  | <i>kit di cablaggio</i> · wiring kit |
|  | <i>kit di cablaggio escluso</i> · wiring kit not included |
|  | <i>lampadina con sorgente elettronica led, ad incandescenza, alogena o fluorescente inclusa.</i> bulb with led electronic source, incandescent, halogen or fluorescent included. |
|  | <i>lampadina con sorgente elettronica led, ad incandescenza, alogena o fluorescente esclusa.</i> bulb with led electronic source, incandescent, halogen or fluorescent not included. |
|  | <i>propulsore dinamico n55 incluso</i> · included |
|  | <i>possibilità di combinazione tra interfaccia n55, propulsore dinamico n55 e lampadina n55</i> · possible combination between n55 interface, propulsore dinamico n55 and n55 bulb |
|  | <i>attenzione: sorgente luminosa led. non guardare mai direttamente a occhio nudo</i> · attention: led light source. never look straight without eye protection |
|  | <i>flicker free compatibile con fotocamere digitali</i> · flicker free digital camera friendly |
| l.d. | <i>luce diretta</i> · direct light |
| l.i. | <i>luce indiretta</i> · indirect light |
| .d1 | <i>dimmerazione 1-10V</i> · 1-10V dimmable |
| .d2 | <i>dimmerazione dali</i> · dimmable dali |
| .SA | <i>kit luce + emergenza sempre accese. attenzione: non è possibile installare nelle cassaforme laterizio</i> light kit + permanently lit emergency lamp. please note: cannot be installed in brickwork housing |
| .SE | <i>solo emergenza sempre accesa. attenzione: non è possibile installare nelle cassaforme laterizio</i> permanently lit emergency lamp only. please note: cannot be installed in brickwork housing |
|  | <i>peso netto</i> · net weight (kg) |