



Viabizzuno strada principale della frazione di bizzuno in provincia di ravenna dove tra la casa del popolo e la parrocchia, al n°17, sono nato il ventuno luglio millenovecentocinquantacinque. da qui nasce il nome della fabbrica di produzione fondata nel millenovecentonovantaquattro rappresentata da uno spazio bianco attraversato da due linee. una verticale, rigorosa, essenziale, equilibrata: la luce per la luce; ed una inclinata, irriverente nello spazio, ironica, fuori dagli schemi: la luce per la forma. distinte ma complementari si fondono in un unico nome: Viabizzuno.

marionanni

Viabizzuno is the name of the main road of the small village bizzuno located in the province of ravenna, where I was born on the twenty-first july nineteenfiftyfive at n°17, between the 'casa del popolo' and the local parish church. from here the name of the factory founded in nineteen ninety-four represented by a white space intersected by two lines. one vertical, well balanced, logical, essential: the light for the light. the other one dynamic, irreverent, ironic: the light for the form. separate and yet complementary they cast in the same name: Viabizzuno.

prodotto
product



schede tecniche
technical data sheet



curve fotometriche
photometric curves



modelli 3d per i tuoi render
3d models for your render





apparecchio di illuminazione per interni ed esterni IP65. realizzato con uno stelo in fibra di carbonio diametro Ø5mm, ha la possibilità di essere fissato al terreno tramite picchetto in acciaio inox AISI 316L o direttamente su base quadrata 140x140mm in ferro verniciato a polvere per esterni.
modelli:
lucciola h.1000mm, h.2000mm, h.3000mm,
cablato con sorgente elettronica 3000K
fino a 2,2W 130lm.
alimentatore in corrente costante escluso, da installare remoto.
diffusore in vetro trasparente per uso interno e diffusore in silicone trasparente adatto agli ambienti esterni grazie alla sua resistenza termica e meccanica inclusi.
accessori: cappucci, alimentatori, sistema di derivazione corrente costante
finiture: bruno.

IP65 rated light fitting for indoor and outdoor use.
made of a diameter Ø5mm carbon fibre rod, it can be fixed to the ground with a AISI 316L stainless steel stake or directly to a 140x140mm powder coated iron square bases for outdoor use.
versions:
lucciola h.1000mm, h.2000mm, h.3000mm,
wired with 3000K led source up to 2.2W 130lm.
constant current power supply not included, to be installed remotely.
transparent glass diffuser for indoor use and transparent silicone diffuser suited for outdoor use, thanks to its thermal and mechanical resistance, included.
accessories: covers, power supplies, cc derivation hub.
finishes: brown

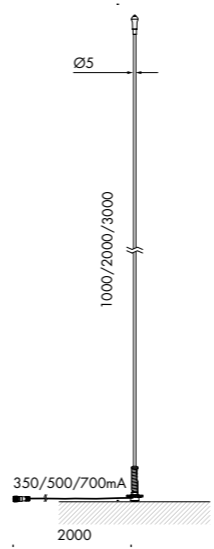

lucciola

Vb4.503.01	bruno · brown	3000K	1000mm	0,5
Vb4.503.02	bruno · brown	3000K	2000mm	1
Vb4.503.03	bruno · brown	3000K	3000mm	1,5

Ra	ies tm-30		sdc	mA	V _{f (min)}	lm	W	lm/W	
90	Rf 90	Rg 100	step 2	350	3,0	79	1	79	F
				500	3,0	104	1,5	70,3	G
				700	3,0	130	2,2	59	G
ca041	les2	Ta25 °C	vita media · average life	50000 h	L80	B10			



collezione · collection triennale design museum milano

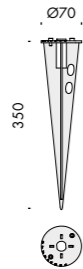
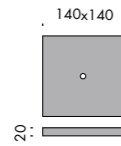

componenti. components.

☆ CE i

a9.503.81 base nero notte · night black base 2,5

f9.009.02 picchetto per fissaggio terra · ground fixing peg 0,7



cappucci. covers.

☆ CE i

a9.503.90 vetro trasparente · transparent glass 0,1

a9.503.94 silicone trasparente · transparent silicone 0,1

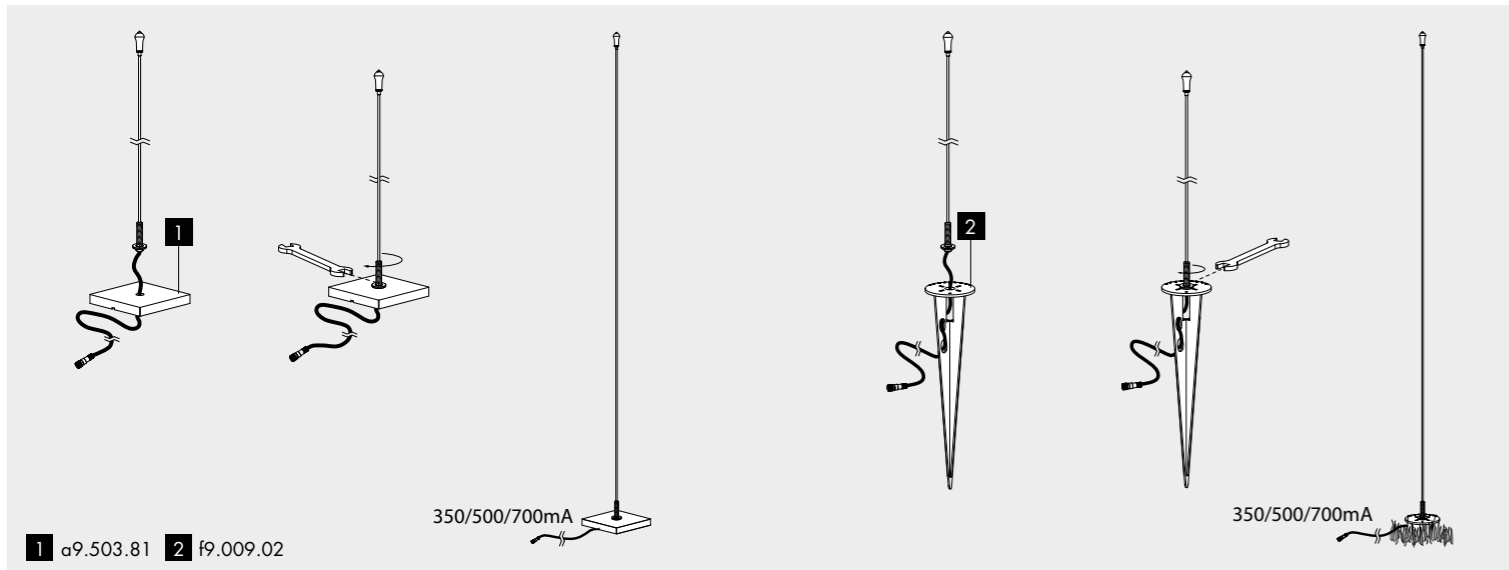

1 a9.503.81 2 f9.009.02





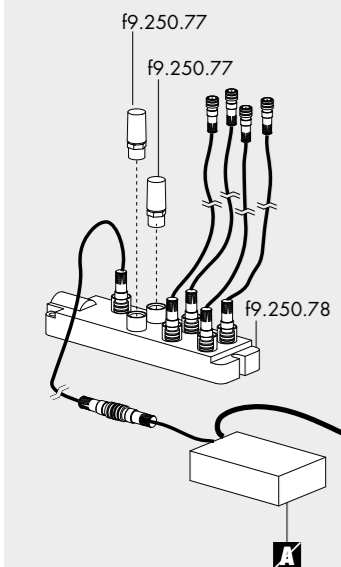
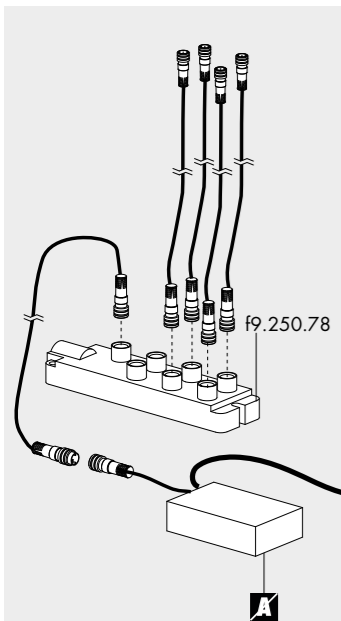

attenzione: è obbligatorio inserire f9.250.77 in tutte le derivazioni non utilizzate
 please note: it is compulsory to insert f9.250.77 in all the not used shunts

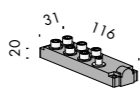

cavi con connettore femmina m8. cables with m8 female connector. IP65 ☆ CE i

f9.250.70	150mm	0,01
f9.164.86	2000mm	0,1
f9.164.87	5000mm	0,2
f9.164.88	10000mm	0,3

cavi con connettori m/f m8. cables with m/f m8 connectors. IP65 ☆ CE i

f9.250.72	2000mm	0,1
f9.250.73	5000mm	0,3
f9.250.74	10000mm	0,5

sistema di derivazione corrente costante. cc derivation hub. ☆ CE i

f9.250.78	con 6 connettori femmina +1 connettore maschio m8 with 6 female connectors + 1 male connector m8	0,1
f9.250.77	tappo maschio bypass per f9.250.78 male bypass caps	0,1



lettura delle tabelle tecniche how to read technical tables

gradi di protezione protection degrees

xxxxxxxxxxxxxxxx										230V 50-60Hz		A	⊕	IP66	⚡	UL	CE	🔒
a	b	c	d	e	f	g	g	h	i									

xxxxxxxxxxxxxxxx										230V 50-60Hz		A	⊕	IP66	⚡	UL	CE	🔒
Vbx.xxx.xx	nero55			3000K	35W				1,5									
l	m			n	o				i									

componenti. components.										IK10		CE	🔒
-------------------------	--	--	--	--	--	--	--	--	--	------	--	----	---

accessori. accessories.										IK10		CE	🔒
-------------------------	--	--	--	--	--	--	--	--	--	------	--	----	---

1	2	3	4	5	6	7	8	9	
Ra	R9	ies tm-30		sdc	mA	V _{f (min)}	lm	W	lm/W
98	98	Rf 96	Rg 103	step 1	350	27,6	1240	9,7	128
					500	27,9	1580	14,0	113
xm000	les19	☀️	Ta25 °C	vita media · average life	70000 h	L80	B10		
10	11							12	13

bandella tecnica. posizioni standard simbologie.
data plate. standard arrangement of symbols.

a	nome apparecchio di illuminazione · light fitting name
b	tensione di alimentazione · supply rating (Volt)
c	frequenza di alimentazione · supply frequency (Hertz)
d	alimentatore incluso o escluso · power supply included or not included
e	classe di isolamento · insulation class
f	grado di protezione · protection degree
g	marchio di certificazione · safety and quality standards certification
h	conforme alle direttive europee produced in compliance with EC directives
i	peso netto · net weight (kg)
l	codice · code
m	finitura · finish
n	temperatura colore sorgente elettronica colour temperature led source (Kelvin)
o	potenza della sorgente · source power (Watt)

componenti. identifica tutti gli elementi indispensabili per la corretta funzionalità e installazione dell'apparecchio di illuminazione.
components. includes all items that are essential to the correct operation and installation of the light fitting.

accessori. si riferisce alle ulteriori parti installabili sull'apparecchio.
accessories. refers to items that can be added to the light fitting.

1	indice di resa cromatica · colour rendering index
2	indice di resa del rosso · red colour rendering index
3	Rf indice di fedeltà colore · colour fidelity index Rg indice di saturazione colore · color gamut index
4	step di macadam · macadam step
5	corrente di alimentazione · power supply current
6	tensione di alimentazione · power supply voltage
7	flusso luminoso · light flux
8	potenza della sorgente · source power
9	efficienza della sorgente · source efficiency
10	codice sorgente elettronica Viabizzuno · Viabizzuno led source code
11	superficie emittente · light emitting surface (mm)
12	% flusso residuo a fine vita · end life % flux
13	% consentita sotto limite · allowed % under limit

IPX0 non protetto
no protection

IPX1 protetto contro la caduta verticale di gocce d'acqua
protected against water drops falling vertically

IPX2 protetto contro la caduta di gocce con inclinazione max 15°
protected against water drops max inclination 15°

IPX3 protetto contro la caduta di gocce con inclinazione max 60°
protected against water drops max inclination 60°

IPX4 protetto contro spruzzi d'acqua
protected against sprinkling water

IPX5 protetto contro getti d'acqua
protected against water jets

IPX6 protetto contro inondazioni
protected against flooding

IPX7 per breve immersione
protected against brief immersions

IPX8 per immersione prolungata
protected against long immersion

IPOX non protetto
no protection

IP1X contro corpi estranei >50 mm
protection against solid objects

IP2X contro corpi estranei >12 mm
protection against solid objects

IP3X contro corpi estranei >2,5 mm
protection against solid objects

IP4X contro corpi estranei >1 mm
protection against solid objects

IP5X protezione da polvere
dust-protected

IP6X stagno alla polvere
dust-proof

IK01 nessuna protezione
no protection

IK01 protetto contro l'energia d'urto 0,15J
protected against collision energy

IK02 protetto contro l'energia d'urto 0,2J
protected against collision energy

IK03 protetto contro l'energia d'urto 0,35J
protected against collision energy

IK04 protetto contro l'energia d'urto 0,5J
protected against collision energy

IK05 protetto contro l'energia d'urto 0,7J
protected against collision energy

IK06 protetto contro l'energia d'urto 1J
protected against collision energy



























IK07 protetto contro l'energia d'urto 2J
protected against collision energy

IK08 protetto contro l'energia d'urto 5J
protected against collision energy

IK09 protetto contro l'energia d'urto 10J
protected against collision energy

IK10 protetto contro l'energia d'urto 20J
protected against collision energy

legenda simboli symbols key

	<i>tavolo</i> · table
	<i>terra</i> · floor standing
	<i>soffitto</i> · ceiling
	<i>parete</i> · wall
	<i>sospensione</i> · suspension
	<i>binario</i> · track
	<i>incasso</i> · recessed
	<i>scomparsa totale</i> · fully concealed
	<i>segnaletica+emergenza</i> · signalling system+emergency
	<i>portatili autoalimentati a batteria</i> · portable self-powered with battery
	<i>sistemi</i> · systems
	<i>palo</i> · pole
	<i>paletto</i> · bollard
	<i>seduta</i> · sitting
	<i>disponibile su</i> · available on <i>Viabizzuno applight</i> <i>www.Viabizzuno.com</i> <i>Viabizzuno online</i>
	<i>classe I. solo isolamento fondamentale, le parti conduttrici accessibili sono collegate ad un conduttore di terra. messa a terra tassativa</i> class I. only basic insulation, accessible conductors are earthed. earthing compulsory
	<i>classe II. all'isolamento principale è aggiunto un secondo isolamento oppure ai due isolamenti è sostituito un isolamento rinforzato. messa a terra esclusa</i> class II. basic insulation plus second insulation or both are replaced by reinforced insulation. earthing excluded
	<i>classe III. alimentazione effettuata con bassissima tensione di sicurezza; sono escluse tensioni superiori a 50V-50Hz. messa a terra non prevista.</i> class III. very low safety supply tension; not to be used over 50V-50Hz. earthing excluded.
	<i>prodotto conforme alle direttive europee</i> · produced in compliance with ec directives
	<i>marchio di certificazione europea. certifica che il prodotto è conforme alle norme europee sulla sicurezza</i> component approved for north american market and suitable to be used and approved as part of a more complex system
	<i>componente certificato per il mercato nord americano idoneo ad essere utilizzato e valutato come parte di in un sistema più complesso</i> component approved for north american market and suitable to be used and approved as part of a more complex system
	<i>apparecchio di illuminazione approvato da kema</i> · kema approved light fitting
	<i>prodotto conforme agli standard presenti nel regno unito che regolamentano la sicurezza e la qualità dell'acqua</i> · product complies with uk standards set out by water regulations
	<i>apparecchio di illuminazione certificato secondo le normative vigenti in polonia che regolamentano i dispositivi di sicurezza antincendio</i> certified light fitting according to the regulations about devices for fire safety in force in poland
	<i>prodotto idoneo per essere commercializzato nel mercato cinese</i> · product suitable for the china market
	<i>prodotto finito idoneo per essere commercializzato nel mercato nord americano</i> · listed product suitable for the north american market
	<i>apparecchio di illuminazione certificato per il mercato cinese</i> light fitting certified for china market

	<i>vetro opalino</i> · opal glass
	<i>vetro sabbiato</i> · sanded glass
	<i>vetro nero fumè</i> · black smoke glass
	<i>vetro trasparente</i> · transparent glass
	<i>vetro bianco latte</i> · white milk glass
	<i>cristallo</i> · crystal
	<i>policarbonato opalino</i> · opal polycarbonate diffuser
	<i>carrabile</i> · drive over
	<i>alimentatore incluso</i> · power supply included
	<i>alimentatore escluso</i> · power supply not included
	<i>alimentatore remoto incluso</i> · remote power supply included
	<i>alimentatore elettronico con controllo intelligente incluso</i> · electronic power supply with smart control included
	<i>alimentatore elettronico con controllo intelligente incluso, da installare remoto</i> · electronic power supply with smart control included, to be installed remotely
	<i>alimentatore a spina incluso</i> · plug power supply included
	<i>trasformatore incluso</i> · transformer included
	<i>trasformatore escluso</i> · transformer not included
	<i>kit di cablaggio</i> · wiring kit
	<i>kit di cablaggio escluso</i> · wiring kit not included
	<i>lampadina con sorgente elettronica led, ad incandescenza, alogena o fluorescente inclusa.</i> bulb with led electronic source, incandescent, halogen or fluorescent included.
	<i>lampadina con sorgente elettronica led, ad incandescenza, alogena o fluorescente esclusa.</i> bulb with led electronic source, incandescent, halogen or fluorescent not included.
	<i>propulsore dinamico n55 incluso</i> · included
	<i>possibilità di combinazione tra interfaccia n55, propulsore dinamico n55 e lampadina n55</i> · possible combination between n55 interface, propulsore dinamico n55 and n55 bulb
	<i>attenzione: sorgente luminosa led. non guardare mai direttamente a occhio nudo</i> · attention: led light source. never look straight without eye protection
	<i>flicker free compatibile con fotocamere digitali</i> · flicker free digital camera friendly
l.d.	<i>luce diretta</i> · direct light
l.i.	<i>luce indiretta</i> · indirect light
.d1	<i>dimmerazione 1-10V</i> · 1-10V dimmable
.d2	<i>dimmerazione dali</i> · dimmable dali
.SA	<i>kit luce + emergenza sempre accese. attenzione: non è possibile installare nelle cassaforme laterizio</i> light kit + permanently lit emergency lamp. please note: cannot be installed in brickwork housing
.SE	<i>solo emergenza sempre accesa. attenzione: non è possibile installare nelle cassaforme laterizio</i> permanently lit emergency lamp only. please note: cannot be installed in brickwork housing
	<i>peso netto</i> · net weight (kg)