



Viabizzuno strada principale della frazione di bizzuno in provincia di ravenna dove tra la casa del popolo e la parrocchia, al n°17, sono nato il ventuno luglio millenovecentocinquantacinque. da qui nasce il nome della fabbrica di produzione fondata nel millenovecentonovantaquattro rappresentata da uno spazio bianco attraversato da due linee. una verticale, rigorosa, essenziale, equilibrata: la luce per la luce; ed una inclinata, irriverente nello spazio, ironica, fuori dagli schemi: la luce per la forma. distinte ma complementari si fondono in un unico nome: Viabizzuno.

marionanni

Viabizzuno is the name of the main road of the small village bizzuno located in the province of ravenna, where I was born on the twenty-first july nineteenfiftyfive at n°17, between the 'casa del popolo' and the local parish church. from here the name of the factory founded in nineteen ninety-four represented by a white space intersected by two lines. one vertical, well balanced, logical, essential: the light for the light. the other one dynamic, irreverent, ironic: the light for the form. separate and yet complementary they cast in the same name: Viabizzuno.

prodotto
product



schede tecniche
technical data sheet



curve fotometriche
photometric curves



modelli 3d per i tuoi render
3d models for your render





apparecchio di illuminazione da terra per esterni IP65 costituito da un diffusore realizzato in vetroresina fissato ad un palo in acciaio verniciato a polvere, da ancorare ad apposito tirafondo in acciaio h.535mm.





modelli:

maxxi poppy 01 con sezione ellittica 1800x2050mm, altezza fuori terra di 4350mm, cablato con sorgente elettronica 3000K 69,7W, 9633lm, **maxxi poppy 02** con sezione ellittica 1610x1590mm, altezza fuori terra 3930mm, cablato con sorgente elettronica 3000K 69,7W, 9633lm, **poppy 03** con sezione ellittica 840x760mm, altezza fuori terra 2040mm, cablato con sorgente elettronica 3000K 34,2W, 5253lm, alimentatore 240V 50Hz escluso da installare in apposito pozzetto di derivazione. finiture: vetroresina rossa, palo bruno antico.

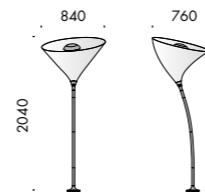
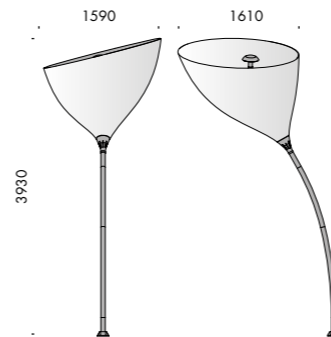
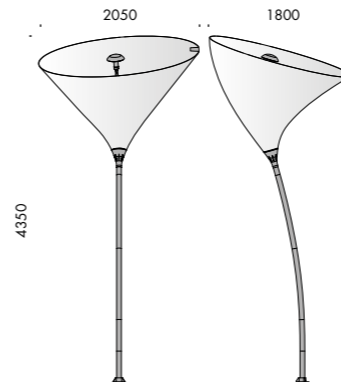
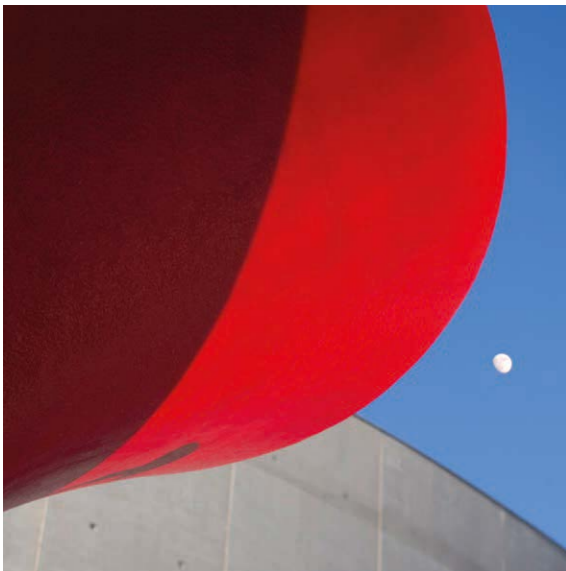
IP65 floor standing light fitting for outdoor use made of a fibreglass diffuser fitted to a powder coated steel pole, to be fixed to a special 535mm high steel ground anchor. versions:





maxxi poppy 01 with 1800x2050mm elliptical section, a height of 4350mm above ground, wired with 3000K 69.7W 9633lm source, **maxxi poppy 02** with 1610x1590mm elliptical section, a height of 3930mm above ground, wired with 3000K 69.7W 9633lm source, **poppy 03** with 840x760mm elliptical section, a height of 2040mm above ground, wired with 3000K 34.2W, 5253lm source, 240V 50Hz power supply not included, to be installed in a special cable draw pit. finishes: red fibreglass, antique brown pole.



maxxi poppy 01   IP65   





Vb4.531.01.1 vetroresina rossa · red fiberglass 3000K 70

| Ra | ies tm-30 | | sdcm | mA | V _f (min) | lm | W | lm/W |
|-------|-----------|--------|---------------------------|------|----------------------|---------|------|------|
| 80 | Rf 83 | Rg 101 | 2 | 2100 | 33,2 | 9633 | 69,7 | 138 |
| Vz065 | Ta25 °C | | vita media · average life | | 50000 h | L80 B10 | | |

maxxi poppy 02   IP65   

Vb4.531.02.1 vetroresina rossa · red fiberglass 3000K 70

| Ra | ies tm-30 | | sdcm | mA | V _f (min) | lm | W | lm/W |
|-------|-----------|--------|---------------------------|------|----------------------|---------|------|------|
| 80 | Rf 83 | Rg 101 | 2 | 2100 | 33,2 | 9633 | 69,7 | 138 |
| Vz065 | Ta25 °C | | vita media · average life | | 50000 h | L80 B10 | | |

poppy 03   IP65   

Vb4.531.11.1 vetroresina rossa · red fiberglass 3000K 57

| Ra | ies tm-30 | | sdcm | mA | V _f (min) | lm | W | lm/W |
|-------|-----------|--------|---------------------------|------|----------------------|---------|------|------|
| 80 | Rf 83 | Rg 101 | 2 | 1050 | 32,6 | 5253 | 34,2 | 154 |
| Vz065 | Ta25 °C | | vita media · average life | | 50000 h | L80 B10 | | |



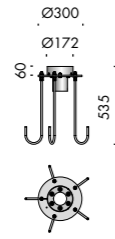
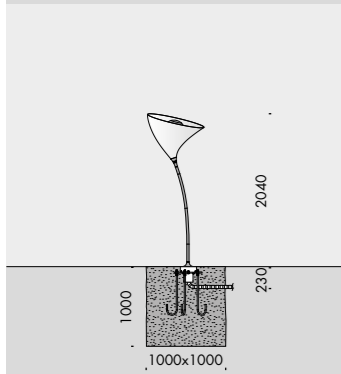
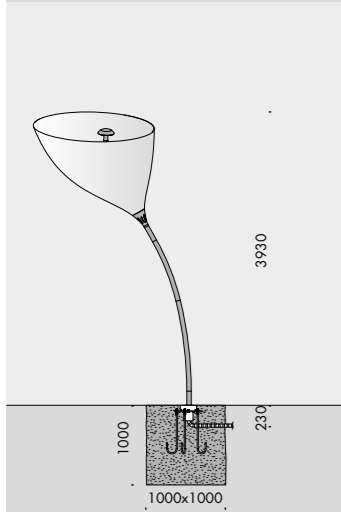
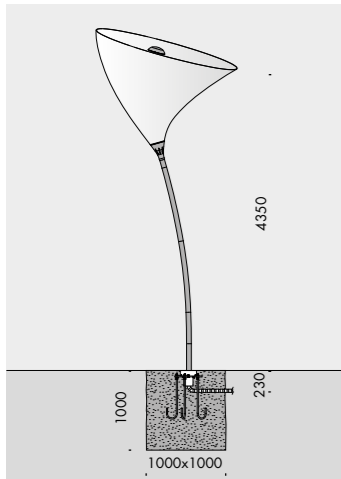

componenti. components. ☆ CE ⓘ

f9.211.91 tirafondo · anchor bolt 10

alimentatori. power supplies. 240V 50Hz A IP67 © CE ⓘ

t4.051 2000mA 100W 1,3

t4.654.d1 1000mA 50W 0,8





lettura delle tabelle tecniche how to read technical tables

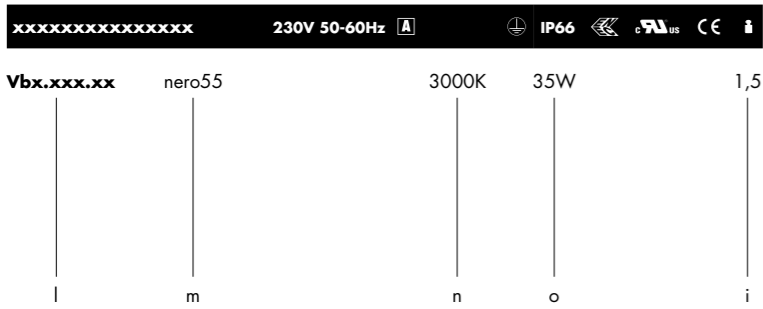
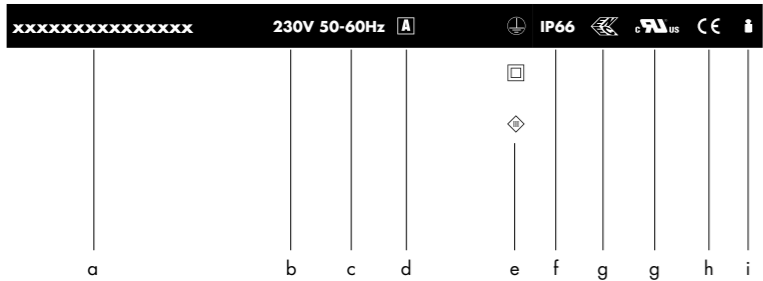

componenti. components. IK10 CE

accessori. accessories. IK10 CE

| 1 | 2 | 3 | 4 | 5 | 6 | 7 | 8 | 9 |
|-------|-------|--------------|---------------------------|------------|----------------------|--------------|-------------|------------|
| Ra | R9 | ies tm-30 | sdcM | mA | V _{f (min)} | lm | W | lm/W |
| 98 | 98 | Rf 96 Rg 103 | step 1 | 350 500 | 27,6 27,9 | 1240 1580 | 9,7 14,0 | 128 113 |
| xm000 | les19 | Ta25 °C | vita media · average life | 70000 h | L80 | B10 | | |
| 10 | 11 | | | | | 12 | 13 | |

bandella tecnica. posizioni standard simbologie.
data plate. standard arrangement of symbols.

| | |
|---|---|
| a | nome apparecchio di illuminazione · light fitting name |
| b | tensione di alimentazione · supply rating (Volt) |
| c | frequenza di alimentazione · supply frequency (Hertz) |
| d | alimentatore incluso o escluso · power supply included or not included |
| e | classe di isolamento · insulation class |
| f | grado di protezione · protection degree |
| g | marchio di certificazione · safety and quality standards certification |
| h | conforme alle direttive europee produced in compliance with EC directives |
| i | peso netto · net weight (kg) |
| l | codice · code |
| m | finitura · finish |
| n | temperatura colore sorgente elettronica colour temperature led source (Kelvin) |
| o | potenza della sorgente · source power (Watt) |

componenti. identifica tutti gli elementi indispensabili per la corretta funzionalità e installazione dell'apparecchio di illuminazione.
components. includes all items that are essential to the correct operation and installation of the light fitting.

accessori. si riferisce alle ulteriori parti installabili sull'apparecchio.
accessories. refers to items that can be added to the light fitting.

| | |
|----|--|
| 1 | indice di resa cromatica · colour rendering index |
| 2 | indice di resa del rosso · red colour rendering index |
| 3 | Rf indice di fedeltà colore · colour fidelity index Rg indice di saturazione colore · color gamut index |
| 4 | step di macadam · macadam step |
| 5 | corrente di alimentazione · power supply current |
| 6 | tensione di alimentazione · power supply voltage |
| 7 | flusso luminoso · light flux |
| 8 | potenza della sorgente · source power |
| 9 | efficienza della sorgente · source efficiency |
| 10 | codice sorgente elettronica Viabizzuno · Viabizzuno led source code |
| 11 | superficie emittente · light emitting surface (mm) |
| 12 | % flusso residuo a fine vita · end life % flux |
| 13 | % consentita sotto limite · allowed % under limit |

gradi di protezione protection degrees

| | | | |
|-------|--|------|--|
| IPX0 | non protetto no protection | IK01 | nessuna protezione no protection |
| IPX1 | protetto contro la caduta verticale di gocce d'acqua protected against water drops falling vertically | IK01 | protetto contro l'energia d'urto 0,15J protected against collision energy |
| IPX2 | protetto contro la caduta di gocce con inclinazione max 15° protected against water drops max inclination 15° | IK02 | protetto contro l'energia d'urto 0,2J protected against collision energy |
| IPX3 | protetto contro la caduta di gocce con inclinazione max 60° protected against water drops max inclination 60° | IK03 | protetto contro l'energia d'urto 0,35J protected against collision energy |
| IPX4 | protetto contro spruzzi d'acqua protected against sprinkling water | IK04 | protetto contro l'energia d'urto 0,5J protected against collision energy |
| IPX5 | protetto contro getti d'acqua protected against water jets | IK05 | protetto contro l'energia d'urto 0,7J protected against collision energy |
| IPX6 | protetto contro inondazioni protected against flooding | IK06 | protetto contro l'energia d'urto 1J protected against collision energy |
| IPX7 | per breve immersione protected against brief immersions | IK07 | protetto contro l'energia d'urto 2J protected against collision energy |
| IPX8 | per immersione prolungata protected against long immersion | IK08 | protetto contro l'energia d'urto 5J protected against collision energy |
| IPX9 | per immersione prolungata protected against long immersion | IK09 | protetto contro l'energia d'urto 10J protected against collision energy |
| IPX10 | per immersione prolungata protected against long immersion | IK10 | protetto contro l'energia d'urto 20J protected against collision energy |

| | |
|------|---|
| IPOX | non protetto no protection |
| IP1X | contro corpi estranei >50 mm protection against solid objects |
| IP2X | contro corpi estranei >12 mm protection against solid objects |
| IP3X | contro corpi estranei >2,5 mm protection against solid objects |
| IP4X | contro corpi estranei >1 mm protection against solid objects |
| IP5X | protezione da polvere dust-protected |
| IP6X | stagno alla polvere dust-proof |

legenda simboli symbols key

| | |
|---|--|
| ta | <i>tavolo</i> · table |
| tr | <i>terra</i> · floor standing |
| s | <i>soffitto</i> · ceiling |
| p | <i>parete</i> · wall |
| sp | <i>sospensione</i> · suspension |
| bin | <i>binario</i> · track |
| in | <i>incasso</i> · recessed |
| st | <i>scomparsa totale</i> · fully concealed |
| s+e | <i>segnaletica+emergenza</i> · signalling system+emergency |
| bat | <i>portatili autoalimentati a batteria</i> · portable self-powered with battery |
| sis | <i>sistemi</i> · systems |
| pa | <i>palo</i> · pole |
| pt | <i>palletto</i> · bollard |
| sd | <i>seduta</i> · sitting |
| V | <i>disponibile su</i> · available on <i>Viabizzuno applight</i> <i>www.Viabizzuno.com</i> <i>Viabizzuno online</i> |
|  | <i>classe I. solo isolamento fondamentale, le parti conduttrici accessibili sono collegate ad un conduttore di terra. messa a terra tassativa</i> class I. only basic insulation, accessible conductors are earthed. earthing compulsory |
|  | <i>classe II. all'isolamento principale è aggiunto un secondo isolamento oppure ai due isolamenti è sostituito un isolamento rinforzato. messa a terra esclusa</i> class II. basic insulation plus second insulation or both are replaced by reinforced insulation. earthing excluded |
|  | <i>classe III. alimentazione effettuata con bassissima tensione di sicurezza; sono escluse tensioni superiori a 50V-50Hz. messa a terra non prevista.</i> class III. very low safety supply tension; not to be used over 50V-50Hz. earthing excluded. |
| CE | <i>prodotto conforme alle direttive europee</i> · produced in compliance with ec directives |
|  | <i>marchio di certificazione europea. certifica che il prodotto è conforme alle norme europee sulla sicurezza</i> component approved for north american market and suitable to be used and approved as part of a more complex system |
| c us | <i>componente certificato per il mercato nord americano idoneo ad essere utilizzato e valutato come parte di in un sistema più complesso</i> component approved for north american market and suitable to be used and approved as part of a more complex system |
| KEMA | <i>apparecchio di illuminazione approvato da kema</i> · kema approved light fitting |
| WRAS | <i>prodotto conforme agli standard presenti nel regno unito che regolamentano la sicurezza e la qualità dell'acqua</i> · product complies with uk standards set out by water regulations |
|  | <i>apparecchio di illuminazione certificato secondo le normative vigenti in polonia che regolamentano i dispositivi di sicurezza antincendio</i> certified light fitting according to the regulations about devices for fire safety in force in poland |
|  | <i>prodotto idoneo per essere commercializzato nel mercato cinese</i> · product suitable for the china market |
|  | <i>prodotto finito idoneo per essere commercializzato nel mercato nord americano</i> · listed product suitable for the north american market |
| UK CA | <i>prodotto conforme alla legislazione vigente nel regno unito</i> · produced in compliance with UK legislation |
|  | <i>apparecchio di illuminazione certificato per il mercato cinese</i> light fitting certified for china market |

| | |
|---|--|
|  | <i>vetro opalino</i> · opal glass |
|  | <i>vetro sabbiato</i> · sanded glass |
|  | <i>vetro nero fumè</i> · black smoke glass |
|  | <i>vetro trasparente</i> · transparent glass |
|  | <i>vetro bianco latte</i> · white milk glass |
|  | <i>crystallo</i> · crystal |
|  | <i>policarbonato opalino</i> · opal polycarbonate diffuser |
|  | <i>carrabile</i> · drive over |
| A | <i>alimentatore incluso</i> · power supply included |
|  | <i>alimentatore escluso</i> · power supply not included |
| AR | <i>alimentatore remoto incluso</i> · remote power supply included |
| Ai | <i>alimentatore elettronico con controllo intelligente incluso</i> · electronic power supply with smart control included |
| AiR | <i>alimentatore elettronico con controllo intelligente incluso, da installare remoto</i> · electonic power supply with smart control included, to be installed remotely |
| AS | <i>alimentatore a spina incluso</i> · plug power supply included |
| T | <i>trasformatore incluso</i> · transformer included |
|  | <i>trasformatore escluso</i> · transformer not included |
| K | <i>kit di cablaggio</i> · wiring kit |
|  | <i>kit di cablaggio escluso</i> · wiring kit not included |
| L | <i>lampadina con sorgente elettronica led, ad incandescenza, alogena o fluorescente inclusa.</i> bulb with led electronic source, incandescent, halogen or fluoresecent included. |
|  | <i>lampadina con sorgente elettronica led, ad incandescenza, alogena o fluorescente esclusa.</i> bulb with led electronic source, incandescent, halogen or fluoresecent not included. |
| Pr | <i>propulsore dinamico n55 incluso</i> · included |
|  | <i>propulsore dinamico n55 escluso</i> · not included |
| df | <i>diffusore incluso</i> · diffuser included |
|  | <i>diffusore escluso</i> · diffuser not included |
|  | <i>possibilità di combinazione tra interfaccia n55, propulsore dinamico n55 e lampadina n55</i> · possible combination between n55 interface, propulsore dinamico n55 and n55 bulb |
|  | <i>attenzione: sorgente luminosa led. non guardare mai direttamente a occhio nudo</i> · attention: led light source. never look straight without eye protection |
| ff | <i>flicker free compatibile con fotocamere digitali</i> · flicker free digital camera friendly |
| l.d. | <i>luce diretta</i> · direct light |
| l.i. | <i>luce indiretta</i> · indirect light |
| .d1 | <i>dimmerazione 1-10V</i> · 1-10V dimmable |
| .d2 | <i>dimmerazione dali</i> · dimmable dali |
| .SA | <i>kit luce + emergenza sempre accese. attenzione: non è possibile installare nelle cassafornne laterizio</i> light kit + permanently lit emergency lamp. please note: cannot be installed in brickwork housing |
| .SE | <i>solo emergenza sempre accesa. attenzione: non è possibile installare nelle cassafornne laterizio</i> permanently lit emergency lamp only. please note: cannot be installed in brickwork housing |
| i | <i>peso netto</i> · net weight (kg) |