



*Viabizzuno strada principale della frazione di bizzuno in provincia di ravenna dove tra la casa del popolo e la parrocchia, al n°17, sono nato il ventuno luglio millenovecentocinquantacinque. da qui nasce il nome della fabbrica di produzione fondata nel millenovecentonovantaquattro rappresentata da uno spazio bianco attraversato da due linee. una verticale, rigorosa, essenziale, equilibrata: la luce per la luce; ed una inclinata, irriverente nello spazio, ironica, fuori dagli schemi: la luce per la forma. distinte ma complementari si fondono in un unico nome: Viabizzuno.*

*marionanni*

Viabizzuno is the name of the main road of the small village bizzuno located in the province of ravenna, where I was born on the twenty-first july nineteenfiftyfive at n°17, between the 'casa del popolo' and the local parish church. from here the name of the factory founded in nineteen ninety-four represented by a white space intersected by two lines. one vertical, well balanced, logical, essential: the light for the light. the other one dynamic, irreverent, ironic: the light for the form. separate and yet complementary they cast in the same name: Viabizzuno.

prodotto  
product



schede tecniche  
technical data sheet



curve fotometriche  
photometric curves



modelli 3d per i tuoi render  
3d models for your render





apparecchio di illuminazione da terra, parete, soffitto e sospensione da interno ed esterno IP67. realizzato con un cilindro in vetro pyrex di spessore 2,8mm e diametro Ø34mm, chiuso all'estremità con tappi in acciaio inox AISI 316L diametro Ø45mm: uno cieco e uno con connettore IP67 maschio quattro poli. cablato con sorgente elettronica 3000K, 4000K e 5000K Ra95 26,1W per 672mm, 37,8W per 972mm, 49,5W per 1272mm e 57,3W per 1472mm. con emissione diffusa 84°x110°.

le tre linee di luce possono essere comandate separatamente da impianto remoto in modo da ottenere effetti luminosi diversi in tutta la gamma possibile dei bianchi. alimentatore in tensione costante escluso, da installare remoto. accessori: cavi in acciaio per sospensione, supporti in acciaio inox AISI 316L per fissaggio a parete e cavi o prolunghe di alimentazione con connettori IP67 finitura: vetro trasparente e inox lucido passivato.

IP67 rated floor-standing, wall, ceiling and suspended light fitting for indoor and outdoor use. it consists of a 2.8mm diameter Ø34mm pyrex glass cylinder, which is closed at the end by diameter Ø45mm AISI 316L stainless steel caps: one is a blind cap and one is a 4-pole IP67 male connector.

it is wired with 3000K, 4000K and 5000K Ra95 led source at 26.1W for 672mm, 37.8W for 972mm, 49.5W for 1272mm and 57.3W for 1472mm. with 84°x110° diffused emission.

these three light lines can be controlled separately by a remote system to obtain different lighting effects in all possible shades of white. constant current power supply not included, to be installed remotely. accessories: suspension steel cables, AISI 316L stainless steel supports for wall installation and power cables/extensions with IP67 connectors. finishes: transparent glass and passivated polished stainless steel.

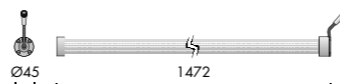
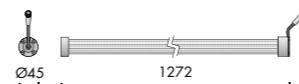
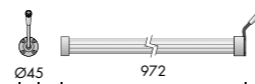
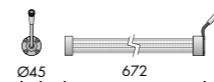

unaghi	24Vdc	IP67	★	CE	i
<b>Vb6.219.01</b> vetro · glass	3000K	8,7W	84°x 110°	672mm	1
	4000K	8,7W	84°x 110°		
	5000K	8,7W	84°x 110°		
<b>Vb6.219.03</b> vetro · glass	3000K	12,6W	84°x 110°	972mm	1,6
	4000K	12,6W	84°x 110°		
	5000K	12,6W	84°x 110°		
<b>Vb6.219.05</b> vetro · glass	3000K	16,5W	84°x 110°	1272mm	2,3
	4000K	16,5W	84°x 110°		
	5000K	16,5W	84°x 110°		
<b>Vb6.219.07</b> vetro · glass	3000K	19,1W	84°x 110°	1472mm	2,9
	4000K	19,1W	84°x 110°		
	5000K	19,1W	84°x 110°		

3000K									
Ra	R9	ies tm/30		sdcm	Vf	lm/m	W/m	lm/W	
95	90	Rf 93	Rg 102	step 2	24	1250	13	96	
V0001	5,9	Ta25 °C		vita media · average life	50000 h	L80	B10		

  

4000K									
Ra	R9	ies tm/30		sdcm	Vf	lm/m	W/m	lm/W	
95	95	Rf 90	Rg 98	step 2	24	1300	13	100	
V0003	5,9	Ta25 °C		vita media · average life	50000 h	L80	B10		

5000K									
Ra	R9	ies tm/30		sdcm	Vf	lm/m	W/m	lm/W	
95	95	Rf 90	Rg 98	step 2	24	1300	13	100	
V0005	5,9	Ta25 °C		vita media · average life	50000 h	L80	B10		

attenzione, se si vuole allineare due o più unaghi e mantenere la continuità delle temperature colore dei led, posizionare i connettori come in figura please note, if you want to align two or more unaghi and maintain continuity of led's color temperatures, place the connectors as shown



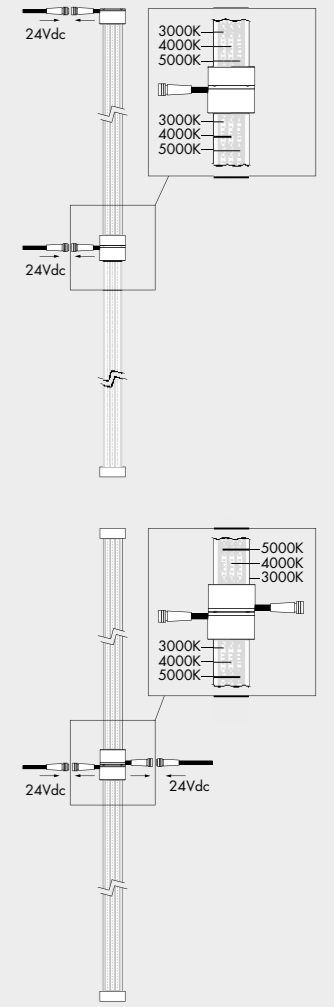

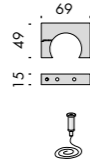
unaghi: *dal giapponese 'anguilla di acqua dolce', nel variegato panorama delle credenze popolari nipponiche, unagi hime, letteralmente 'principessa anguilla', è il nome di un tipo di anguilla dalla coda lunga che secondo la leggenda sarebbe in grado di prendere le sembianze di una bella donna e popolerebbe i laghi della prefettura di miyagi, facendo riecheggiare nei dintorni il rumore del telaio con cui tesse ogni giorno trame preziose. un lontano ticchettio che, da secoli, viene vissuto dagli umani come un segno di protezione e benevolenza.*

unaghi: *from the japanese 'freshwater eel'. in the richly varied panorama of popular japanese beliefs, unagi hime, literally 'princess eel', is the name of a type of eel with a long tail which according to the legend was able to assume the appearance of a beautiful woman and populate the lakes of the prefecture of miyagi, making the sound of the loom with which she wove beautiful cloth echo throughout the surrounding area. a distant ticking which for centuries has been regarded by humans as a sign of protection and benevolence.*

**connettore femmina m12. female connector m12.** IP67 ☆ CE i

**f9.250.61** 150mm 0,09

**connettori m/f m12. connectors m12 m/f.** IP67 ☆ CE i

**f9.250.62** 2000mm 0,3

**f9.250.63** 5000mm 0,6

**f9.250.64** 10000mm 1,2

**accessori. accessories.** ☆ CE i

**f9.219.81.1** supporti soffitto/parete inox AISI 316L  
AISI 316L stainless steel wall/ceiling supports 2 pz · pcs 0,5

**f9.219.83** cavi di sospensione · suspension cables 2 pz · pcs 0,2

montaggio a parete o soffitto  
wall or ceiling mounting  
f9.219.81.1

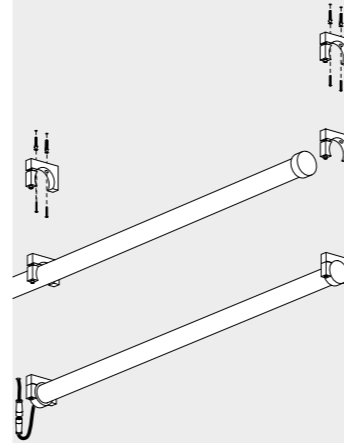

montaggio a sospensione  
suspension mounting  
f9.219.83

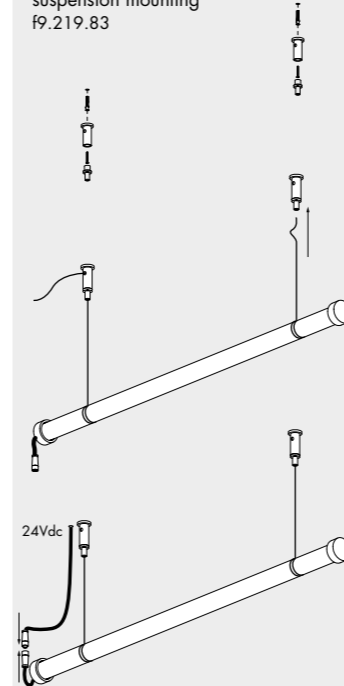

3000K



4000K



5000K



**lettura delle tabelle tecniche how to read technical tables**

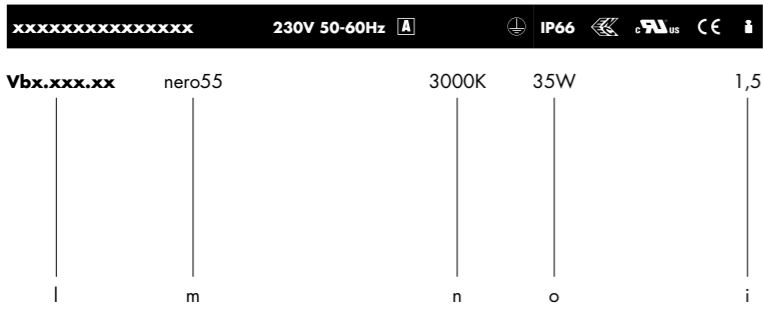
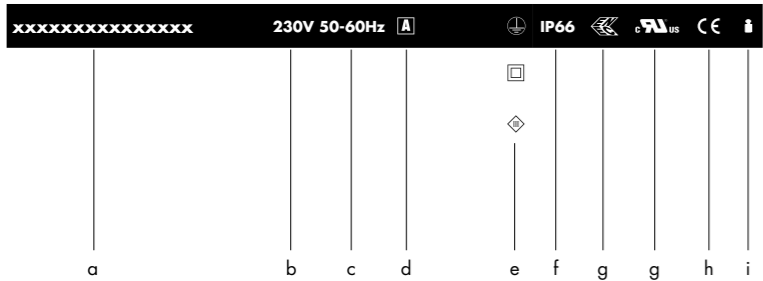

**componenti. components.** IK10 CE

**accessori. accessories.** IK10 CE

1	2	3	4	5	6	7	8	9	
Ra	R9	ies tm-30		sdcM	mA	V <sub>f (min)</sub>	lm	W	lm/W
98	98	Rf 96	Rg 103	step 1	350	27,6	1240	9,7	128
					500	27,9	1580	14,0	113
xm000	les19	Ta25 °C		vita media · average life		70000 h	L80	B10	
10	11						12	13	

bandella tecnica. posizioni standard simbologie.  
data plate. standard arrangement of symbols.

a	nome apparecchio di illuminazione · light fitting name
b	tensione di alimentazione · supply rating (Volt)
c	frequenza di alimentazione · supply frequency (Hertz)
d	alimentatore incluso o escluso · power supply included or not included
e	classe di isolamento · insulation class
f	grado di protezione · protection degree
g	marchio di certificazione · safety and quality standards certification
h	conforme alle direttive europee produced in compliance with EC directives
i	peso netto · net weight (kg)
l	codice · code
m	finitura · finish
n	temperatura colore sorgente elettronica colour temperature led source (Kelvin)
o	potenza della sorgente · source power (Watt)

componenti. identifica tutti gli elementi indispensabili per la corretta funzionalità e installazione dell'apparecchio di illuminazione.  
components. includes all items that are essential to the correct operation and installation of the light fitting.

accessori. si riferisce alle ulteriori parti installabili sull'apparecchio.  
accessories. refers to items that can be added to the light fitting.



























1	indice di resa cromatica · colour rendering index
2	indice di resa del rosso · red colour rendering index
3	Rf indice di fedeltà colore · colour fidelity index Rg indice di saturazione colore · color gamut index
4	step di macadam · macadam step
5	corrente di alimentazione · power supply current
6	tensione di alimentazione · power supply voltage
7	flusso luminoso · light flux
8	potenza della sorgente · source power
9	efficienza della sorgente · source efficiency
10	codice sorgente elettronica Viabizzuno · Viabizzuno led source code
11	superficie emittente · light emitting surface (mm)
12	% flusso residuo a fine vita · end life % flux
13	% consentita sotto limite · allowed % under limit

**gradi di protezione protection degrees**

IPX0	non protetto no protection	IK01	nessuna protezione no protection
IPX1	protetto contro la caduta verticale di gocce d'acqua protected against water drops falling vertically	IK01	protetto contro l'energia d'urto 0,15J protected against collision energy
IPX2	protetto contro la caduta di gocce con inclinazione max 15° protected against water drops max inclination 15°	IK02	protetto contro l'energia d'urto 0,2J protected against collision energy
IPX3	protetto contro la caduta di gocce con inclinazione max 60° protected against water drops max inclination 60°	IK03	protetto contro l'energia d'urto 0,35J protected against collision energy
IPX4	protetto contro spruzzi d'acqua protected against sprinkling water	IK04	protetto contro l'energia d'urto 0,5J protected against collision energy
IPX5	protetto contro getti d'acqua protected against water jets	IK05	protetto contro l'energia d'urto 0,7J protected against collision energy
IPX6	protetto contro inondazioni protected against flooding	IK06	protetto contro l'energia d'urto 1J protected against collision energy
IPX7	per breve immersione protected against brief immersions	IK07	protetto contro l'energia d'urto 2J protected against collision energy
IPX8	per immersione prolungata protected against long immersion	IK08	protetto contro l'energia d'urto 5J protected against collision energy
IPX9	per immersione prolungata protected against long immersion	IK09	protetto contro l'energia d'urto 10J protected against collision energy
IPX10	per immersione prolungata protected against long immersion	IK10	protetto contro l'energia d'urto 20J protected against collision energy

IPOX	non protetto no protection
IP1X	contro corpi estranei >50 mm protection against solid objects
IP2X	contro corpi estranei >12 mm protection against solid objects
IP3X	contro corpi estranei >2,5 mm protection against solid objects
IP4X	contro corpi estranei >1 mm protection against solid objects
IP5X	protezione da polvere dust-protected
IP6X	stagno alla polvere dust-proof

## legenda simboli symbols key

	<i>tavolo</i> · table
	<i>terra</i> · floor standing
	<i>soffitto</i> · ceiling
	<i>parete</i> · wall
	<i>sospensione</i> · suspension
	<i>binario</i> · track
	<i>incasso</i> · recessed
	<i>scomparsa totale</i> · fully concealed
	<i>segnaletica+emergenza</i> · signalling system+emergency
	<i>portatili autoalimentati a batteria</i> · portable self-powered with battery
	<i>sistemi</i> · systems
	<i>palo</i> · pole
	<i>paletto</i> · bollard
	<i>seduta</i> · sitting
	<i>disponibile su</i> · available on <i>Viabizzuno applight</i> <i>www.Viabizzuno.com</i> <i>Viabizzuno online</i>
	<i>classe I. solo isolamento fondamentale, le parti conduttrici accessibili sono collegate ad un conduttore di terra. messa a terra tassativa</i> class I. only basic insulation, accessible conductors are earthed. earthing compulsory
	<i>classe II. all'isolamento principale è aggiunto un secondo isolamento oppure ai due isolamenti è sostituito un isolamento rinforzato. messa a terra esclusa</i> class II. basic insulation plus second insulation or both are replaced by reinforced insulation. earthing excluded
	<i>classe III. alimentazione effettuata con bassissima tensione di sicurezza; sono escluse tensioni superiori a 50V-50Hz. messa a terra non prevista.</i> class III. very low safety supply tension; not to be used over 50V-50Hz. earthing excluded.
	<i>prodotto conforme alle direttive europee</i> · produced in compliance with ec directives
	<i>marchio di certificazione europea. certifica che il prodotto è conforme alle norme europee sulla sicurezza</i> component approved for north american market and suitable to be used and approved as part of a more complex system
	<i>componente certificato per il mercato nord americano idoneo ad essere utilizzato e valutato come parte di in un sistema più complesso</i> component approved for north american market and suitable to be used and approved as part of a more complex system
	<i>apparecchio di illuminazione approvato da kema</i> · kema approved light fitting
	<i>prodotto conforme agli standard presenti nel regno unito che regolamentano la sicurezza e la qualità dell'acqua</i> · product complies with uk standards set out by water regulations
	<i>apparecchio di illuminazione certificato secondo le normative vigenti in polonia che regolamentano i dispositivi di sicurezza antincendio</i> certified light fitting according to the regulations about devices for fire safety in force in poland
	<i>prodotto idoneo per essere commercializzato nel mercato cinese</i> · product suitable for the china market
	<i>prodotto finito idoneo per essere commercializzato nel mercato nord americano</i> · listed product suitable for the north american market
	<i>apparecchio di illuminazione certificato per il mercato cinese</i> light fitting certified for china market

	<i>vetro opalino</i> · opal glass
	<i>vetro sabbiato</i> · sanded glass
	<i>vetro nero fumè</i> · black smoke glass
	<i>vetro trasparente</i> · transparent glass
	<i>vetro bianco latte</i> · white milk glass
	<i>cristallo</i> · crystal
	<i>policarbonato opalino</i> · opal polycarbonate diffuser
	<i>carrabile</i> · drive over
	<i>alimentatore incluso</i> · power supply included
	<i>alimentatore escluso</i> · power supply not included
	<i>alimentatore remoto incluso</i> · remote power supply included
	<i>alimentatore elettronico con controllo intelligente incluso</i> · electronic power supply with smart control included
	<i>alimentatore elettronico con controllo intelligente incluso, da installare remoto</i> · electronic power supply with smart control included, to be installed remotely
	<i>alimentatore a spina incluso</i> · plug power supply included
	<i>trasformatore incluso</i> · transformer included
	<i>trasformatore escluso</i> · transformer not included
	<i>kit di cablaggio</i> · wiring kit
	<i>kit di cablaggio escluso</i> · wiring kit not included
	<i>lampadina con sorgente elettronica led, ad incandescenza, alogena o fluorescente inclusa.</i> bulb with led electronic source, incandescent, halogen or fluorescent included.
	<i>lampadina con sorgente elettronica led, ad incandescenza, alogena o fluorescente esclusa.</i> bulb with led electronic source, incandescent, halogen or fluorescent not included.
	<i>propulsore dinamico n55 incluso</i> · included
	<i>possibilità di combinazione tra interfaccia n55, propulsore dinamico n55 e lampadina n55</i> · possible combination between n55 interface, propulsore dinamico n55 and n55 bulb
	<i>attenzione: sorgente luminosa led. non guardare mai direttamente a occhio nudo</i> · attention: led light source. never look straight without eye protection
	<i>flicker free compatibile con fotocamere digitali</i> · flicker free digital camera friendly
<b>l.d.</b>	<i>luce diretta</i> · direct light
<b>l.i.</b>	<i>luce indiretta</i> · indirect light
<b>.d1</b>	<i>dimmerazione 1-10V</i> · 1-10V dimmable
<b>.d2</b>	<i>dimmerazione dali</i> · dimmable dali
<b>.SA</b>	<i>kit luce + emergenza sempre accese. attenzione: non è possibile installare nelle cassaforme laterizio</i> light kit + permanently lit emergency lamp. please note: cannot be installed in brickwork housing
<b>.SE</b>	<i>solo emergenza sempre accesa. attenzione: non è possibile installare nelle cassaforme laterizio</i> permanently lit emergency lamp only. please note: cannot be installed in brickwork housing
	<i>peso netto</i> · net weight (kg)